

COMMONWEALTH OF KENTUCKY

CLASS II INJECTION WELL OPERATORS MANUAL

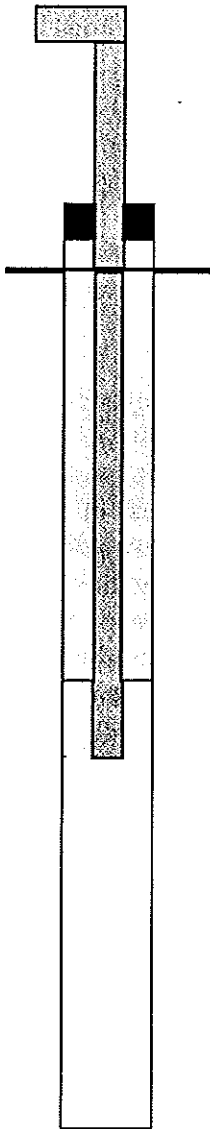

Prepared by:
Division of Oil and Gas
Division of Water
U.S. Environmental Protection Agency
Representatives of the Oil and Gas Industry

UNDERGROUND INJECTION CONTROL PROGRAM

AS ADMINISTERED BY



This report was sponsored by the United States Department of Energy, Office of Fossil Energy, under contract DE-FG22-94MT94006.

For information on this and other energy related projects contact:

US Department of Energy
National Technology Petroleum Office
PO Box 3628
Tulsa, OK 74101
(918) 699-2000

NOTICE: This report was prepared as an account of work sponsored by an agency of the United States Government. Neither the United States Government nor any agency thereof, nor any of their employees, makes any warranty, express or implied, or assumes any legal liability or responsibility for the accuracy, completeness, or usefulness of any information, apparatus, product, or process disclosed, or represents that its use would not infringe with privately owned rights. Reference herein to any specific commercial product, process, or service by trade name, trademark, manufacturer, or otherwise, does not necessarily constitute or imply its endorsement, recommendation, or favoring by the United States Government, any agency thereof or any of their contractors or subcontractors. The views and opinions expressed herein do not necessarily state or reflect those of the United States Government, any agency thereof or any of their contractors.

TABLE OF CONTENTS

Document created April 21, 1998

Forward	v
Introduction.....	vii
Simplified Checklist	ix
Agency Regulatory Authority.....	xvii

SECTION I. GETTING STARTED & PERMITTING

What is a Class II UIC well?.....	1
New Class II Wells and Rule Authorized Wells.....	1
Preparing a Class II Permit Application	2
Attachment A – Area of Review	2
Attachment B – Map of Wells and Area of Review.....	2
Attachment C – Corrective Action Plan and Tabulation of Wells in AOR.....	3
Attachment E – Name and Depth of USDW.....	4
Attachment G – Geologic Data on Injection & Confining Zones.....	4
Attachment H – Operating Data	4
Attachment M – Construction Details.....	4
Attachment Q – Plugging and Abandonment Proposal	5
Attachment R – Financial Responsibility Requirements.....	5
Attachment U – Nature of Business.....	6
Class II Permit Application Exhibits.....	6
EPA Permit Review and Response.....	6
Common Reasons Permits Applications are Denied.....	6
Permit Application – Kentucky Division of Oil and Gas.....	7

SECTION II. NEW WELL CONSTRUCTION & WELL CONVERSION

Construction Requirements	7
Tubing & Packer.....	8

SECTION III. MECHANICAL INTEGRITY TEST (MIT)

What is a mechanical integrity test?.....	8
Wellbore Diagram	8
MIT test procedure	9
When are MITs required?.....	9

SECTION IV. WELL OPERATION & REPORTING

When can injection begin?..... 9
Preparing a Completion Report for Brine Disposal, HC Storage, or Enhanced Recovery Wells.... 10
Operations..... 10
Sampling Requirements..... 11
Reporting Requirements..... 11
Workovers..... 11

Division of Oil & Gas Requirements..... 12

Disposal Alternative – Division of Water..... 12

SECTION V. PERMIT TRANSFERS..... 12

SECTION VI. EMERGENCY NOTIFICATION PROCEDURES..... 13

SECTION VII. ABANDONMENT AND CLOSURE 13

APPENDIX A

Glossary of Terms A1
Kentucky Regulatory Offices..... A3
MIT Inspector..... A3
Federal Regulatory Offices A4

APPENDIX B

Forms
See Appendix Cover Page for Listing of Contents

APPENDIX C

Example Permit Application & Correspondence
See Appendix Cover Page for Listing of Contents

FORWARD

We wish to acknowledge and express our deep appreciation to the following team members that participated in the preparation of this manual. They include the following: Brian Gilpin and Marvin Combs from the Division of Oil and Gas (DOG), Dan Juett from the Division of Water (DOW), and John Gabbard from the Kentucky Oil & Gas Association, Bill Mann, Brian Thames, Ken Harris, Scott Hoskins, and Larry Meyer from the United States Environmental Protection Agency (EPA) Region 4.

We would also like to thank the U.S. Department of Energy for their financial support of this effort. It is our firm belief that the development of this document shall serve as a useful tool for achieving compliance and fostering further exploration efforts in the Commonwealth of Kentucky. The Department of Energy should be commended for their support and encouragement of this and other similar projects.



Rick Bender, Director
Division of Oil and Gas

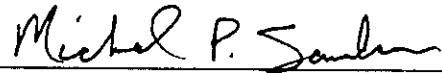

Mike Sanders, Geologist
Author

INTRODUCTION

This handbook is intended to serve as a guide and reference for oil and gas well operators who wish to operate Class II injection wells in the Commonwealth of Kentucky under the federal Underground Injection Control (UIC) program. The UIC program was mandated by the Safe Drinking Water Act of 1980. A Class II well is any well used for injection or disposal of produced water from oil and gas wells, or for injection of fluids to increase recovery of oil and gas. Kentucky's UIC Class II program is currently being regulated by the United States Environmental Protection Agency (EPA). The EPA has regulated the UIC program in Kentucky since June 25, 1984.

The contents of this manual are presented in the order that a typical oil and gas operator would follow to permit, to operate, and to plug and abandon an injection well. A simplified step-by-step checklist is included which also follows this process from beginning to end.

Several recommendations have been presented in this manual that are not EPA requirements under the law, but have been included to help operators avoid future problems.

The appendices, at the back of this manual, contain a glossary of terms, directories of state and federal agencies involved in the UIC program, copies of the forms you will need to permit and operate a UIC well, and other useful information. EPA has provided some completed permit applications, and samples of their correspondence with operators during the permitting and completion process. These should be helpful guides for you to understand the type of information EPA expects from operators.

This handbook was prepared with the help of representatives from Kentucky regulatory agencies and the United States Environmental Protection Agency Region 4, with a grant from the U.S. Department of Energy.

If you wish to permit a UIC Class II well in Kentucky, or if you have questions about Kentucky's injection well program, contact the EPA Region 4 offices in Atlanta, Georgia. See Appendix B at the back of this manual for the address and phone number.

This manual is presented as a general reference and illustrates those practices conforming to the EPA UIC Class II program. It is beyond the scope of this manual to cite every applicable state and federal regulation and statute, and thus this manual is not intended to take the place of one's responsibility to know and understand all applicable regulations and statutes. Statutes and regulations in this manual are not provided in their complete form. The reader is encouraged to read the full text of each statute and regulation and seek counsel if and when necessary for clarification as to the applicability of each.

Simplified Step-by-Step
Checklist (☑) Procedure
for Permitting and Operating a UIC Class II Well in Kentucky

Section 1. Getting Started & Permitting

- Prepare a Game Plan.** Permitting of a UIC well takes several months. Other production wells within the ¼ mile area of review (AOR) are involved in the permitting process. It is recommended that the operator prepare an overall game plan that incorporates all wells in the field to determine the most effective secondary recovery pattern or the most effective disposal option. In addition, many old wells that fall within the AOR may need improvements to their casing and cement in order to comply with the EPA requirements.
- A Proposed injection well should not be located in close proximity to faults or fractures.** The presence of these geologic features could be grounds for denial of your permit application.
- Obtain a UIC Class II well permit (EPA Form 7520-6) with the EPA for each proposed new injection well or for the conversion of any existing producing well into an injection well along with attachments A, B, C, E, G, H, M, Q, R, and U.** Financial resources for plugging the well must be available in the form of an approved financial instrument. **Obtain a well permit with the Division of Oil & Gas (DOG) for each proposed new injection well.** Follow the same permitting and bonding procedures for any production well. If an existing production well is to be converted to an injection well, a new DOG permit is not required if the well is bonded and operated under the existing operators' name.

Section 2. New Well Construction & Well Conversion

- Notify Division of Oil and Gas Inspector (name and phone number is on the DOG permit) 24 hrs. before spudding.**
- Set Casing and Cement as specified in Attachment M of the permit application or as specified in EPA permit under "Well Specific Conditions".** Casing and cementing must also meet the minimum requirements specified on your permit with the DOG.
- Follow all DOG, DOW, and Division of Waste Management (DWM) regulations as required for the drilling or reworking of any production well.** See "Oil and Gas Well Operator's Manual".
- Set tubing and packer as specified in EPA permit under "Well Specific Conditions".**
- Keep cement records as invoiced and keep a copy of any geophysical logs run.** These records shall be submitted to EPA to document correct well construction.

- File Completion Report** (EPA Form 7520-10) along with the attachments A, B, C, D, and E described on the back of the form to the EPA upon completion and equipping the injection well. Send by certified mail return receipt requested.
- File Certificate of Completion** (DOG Form ED-23) with the Division of Oil & Gas for newly drilled injection wells and for well conversions.
- File Affidavit of Well Log and Completion Report** (DOG Form ED-3) with the Division of Oil & Gas for newly drilled injection wells within 90 days of completion.

Section 3. Mechanical Integrity Test (MIT)

- A MIT is required for every new injection well or newly converted injection well prior to injection. A MIT is required every 5 years thereafter or if the packer is unseated during a workover or upon accident.
- A MIT is required for all "standard injection wells" every 5 years or if the packer is unseated during a workover or upon accident. A "standard injection well" has been cased and cemented and injection takes place through tubing and packer. "Non-standard injection wells" must have a MIT test every 2 years unless specified differently in the permit. A "non-standard" well injects through a single string of casing, and is not equipped with tubing and packer. These non-standard wells were injection wells prior to June 25, 1984.
- Notify EPA 30 Days** in advance of each proposed mechanical integrity test. The EPA will arrange for a representative to witness the test.
- Each MIT will require the packer to be set as specified by EPA. The annular space must be loaded with an approved fluid, and a minimum of 300 pounds of pressure must be applied to the annulus for 30 minutes with less than 3 % loss or gain in pressure. (3% of 300 pounds is 9 pounds) EPA has approved alternative methods of MITs. Contact the EPA for details.

Section 4. Well Operation and Reporting

- INJECTION MAY NOT BEGIN** until all the conditions of the permit have been satisfied and approved by the EPA.
- Corrective Actions** as specified in the permit for wells within the Area of Review must be completed and approved by the EPA prior to injection.
- Only fluids and gasses brought to surface in connection with conventional oil and gas production may be injected. Fresh water and other approved secondary recovery fluids may also be injected as specified by the permit.

- Injection must occur through tubing and packer for all newly drilled or converted wells. Wells that have been in operation before June 1984 may still inject down casing if authorized by EPA to do so.
- Injection must cease if mechanical integrity is lost.
- Monitor Enhanced Recovery Wells monthly (or more frequently as required by EPA) - record the maximum and average injection pressure, annulus pressure, and cumulative volume in barrels. These figures must be submitted on an annual report to the EPA.
- Monitor Disposal Wells (Commercial or Non-commercial) weekly - record the average and maximum injection pressure, annulus pressure, and cumulative volume in barrels. These figures must be submitted on an annual report.
- Each year submit to EPA the "Annual Disposal/Injection Well Monitoring Report" (EPA Form 7520-11). For injection wells in operation before June 25, 1984 the report is due every October. For all other injection wells, the report must be submitted each year on the 28th of the month following the anniversary of the effective date of the permit.
- Obtain injection fluid analysis every 12 months or whenever changes are made to injection fluid or as required by EPA. A copy of the analysis should be sent to EPA on the same date as your annual monitoring report described above.
- Retain all injection well monitoring records for three (3) years. However, it is recommended that all records be maintained for the life of the well.
- Alternatives to Injection of produced fluids include surface discharge (KPDES permit from DOW is required) or transport off site to an approved injection well (produced water disposal form submitted to DOW is required).

Section 5. Permit Transfers

- Application to Transfer Permit is required by EPA (EPA Form 7520-7). A written agreement between the old and new owner containing a date for transfer of ownership and liability shall be attached along with a submission of financial responsibility for acquiring company. This requirement is the same for "Rule Authorized" wells and permitted wells.
- Well Transfer Permit required by DOG, \$25 fee per well. (DOG Form ED-13)
- Transfer of Ownership form required by DOW registered facilities and KPDES permits
- Bond releases to the seller shall occur once the acquiring company's bonds are in place and financial responsibility has been demonstrated.

Section 6. Emergency Notification Procedures

- Notify EPA if monitoring indicates a significant change in injection pressure or annulus pressure.
- Notify EPA if there is noncompliance with a permit condition or if a malfunction occurs.
- Give Oral Report to EPA within 24 hours from time operator is aware of a problem including the loss of mechanical integrity. Call (404)-562-9743.
- Give Written Report to EPA within 5 days from time operator is aware of a problem including a plan to fix the problem.
- Contain and clean-up oil spills, leaks, discharges or releases of pollutants immediately. For reportable spills notify Environmental Response Team 1-800-928-2380.

Section 7. Abandonment and Closure

- Notify EPA within 30 days after injection is terminated. Plugging is to be done within one year of termination of injection.
- Plugging and Abandonment should follow the plan approved in the permit. If any change to the plan is desired by the operator, a new plan on Form 7520-14 must be submitted to EPA.. Send or fax a letter to EPA requesting that a well be plugged. All P&A plans must be approved prior to plugging.
- Notify DOG Inspector to be sure that the plan meets DOG requirements.
- It is recommended that tubulars be checked for N.O.R.M. (Naturally occurring radioactive material). The survey should be done while tubing is still in place. If N.O.R.M is found, the EPA must be notified within 45 days of the planned plugging. Contact EPA for disposal instructions.
- File plugging affidavit with the Division of Oil and Gas.
- Remove equipment upon closure of lease activities and contact Division of Water for inactivation of registration.
- Request release of bond upon completion of site closure, or upon transfer of wells to another operator with DOG and with EPA.

Regulatory Authority

EPA Underground Injection Control Program

The U.S. Environmental Protection Agency, Underground Injection Control Program is responsible for:

- Preventing contamination of groundwater supplies from underground injection or other activities.
- Regulating Class II wells which are injection and/or disposal wells associated with the production of oil and natural gas.

Federal Regulation-40 CFR 124 and 144 through 148

Division of Oil and Gas

The Department of Mines and Minerals, Division of Oil and Gas is responsible for:

- Regulating the bonding, permitting, drilling, casing, operating and plugging of all wells in Kentucky.
- Protecting the correlative rights of mineral owners.
- Conserving and protecting the crude oil and natural gas reserves of Kentucky.
- Insuring fresh water aquifers and mineable coal seams are protected from unreasonable damage due to production of crude oil and natural gas.

Statute-KRS Chapter 353

Division of Water

The Department for Environmental Protection, Division of Water is responsible for:

- Preserving the water resources of Kentucky.
- Prevention, abatement and control of all water pollution.
- Regulating water pollution from oil and gas facilities.

Statute-KRS Chapters 146, 151 and 224

Division of Waste Management

The Department for Environmental Protection, Division of Waste Management is responsible for:

- Insuring that waste management activities within Kentucky are conducted in a manner to protect human health and the environment.
- Regulating hazardous waste, solid waste, special waste, abandoned sites, underground storage tanks and remediation of chemical and petroleum releases to the environment.

Statute-KRS Chapters 224

Section 1. Getting Started & Permitting

What is a UIC Class II well?

All owners and operators of oil and gas facilities in Kentucky who desire to inject produced water or other approved non-hazardous fluids from their production operations into the subsurface are subject to regulation by the EPA under the Federal Safe Drinking Water Act. Injection wells used for this purpose are classified as Class II injection wells by the EPA. All Class II injection wells must be permitted by the EPA prior to spudding any injection well or converting any producing well into an injection well.

Class II wells are used:

- 1) for the disposal of non-hazardous fluids which are brought to the surface in connection with oil and gas production and treatment
- 2) to inject fluids for enhanced recovery of oil and natural gas
- 3) for the storage of hydrocarbons which are liquid at standard temperature and pressure

Class II wells are not used:

- 1) for the disposal of hazardous fluids
- 2) for injection and withdrawal of natural gas in storage fields

New Class II Injection Wells and Rule Authorized Wells

The EPA has regulated the UIC program in Kentucky since June 25, 1984. Kentucky had hundreds of injection wells in operation at that time, and the EPA granted a blanket permit for those wells. They became known as "Rule Authorized" wells. Each of these wells did not receive its own individual permit, but each well had to pass a mechanical integrity test. Each well must be re-tested every five years if injection is through tubing and packer, and every two years if injection is down casing.

A new injection well drilled or converted after June 25, 1984 must have its own UIC permit. This manual will focus on permitting and operating these "new" wells. However, those differences for "Rule Authorized" wells will be noted throughout the manual.

PREPARING A CLASS II PERMIT APPLICATION EPA – REGION 4

All operators must obtain a UIC Class II permit from the EPA for each well that disposes of produced fluids from oil and gas wells, injects fluids (liquids or gasses) to enhance recovery of oil and gas, or disposes non-hazardous fluids generated from oil and gas activities. Before an injection well is drilled or a producing well is converted into an injection well, a UIC permit must be obtained. Multiple injection wells may be permitted at one time through an area permit application. Contact EPA for further details on this procedure.

Some examples of completed permit applications are located in Appendix of this manual. They have been provided by the EPA to guide you in preparing your own UIC Class II permit application.

Remember that a permit will be processed faster if you supply the permit reviewer with an application that is complete.

A typical Kentucky Class II disposal well or enhanced recovery well permit application consists of a completed front page of EPA Form 7520-6 and the attachments described below:

- **Front Page Form 7520-6** – Complete the front page. Under the section of the form titled: “Class and Type of Well”, use the code letter “D” for a disposal well application, or “R” for an enhanced recovery application. **No fees are required for this application.**

- **Attachment A – Area of Review (AOR) - New Wells & Conversions:**
The area of review is a circle with a ¼ mile radius around the location of the proposed injection well. A sentence that states “the area of review is a ¼ mile radius around the proposed injection well” will satisfy the requirement for this attachment.

- **Attachment B – Maps of Wells and Area of Review - New Wells & Conversion:**
This attachment should be a photocopy of a USGS 7 ½ quadrangle **topographic map**. The scale of this photocopy shall be a minimum of 1”=2000’, however, larger scales are recommended. EPA’s instructions for completing Attachment B suggest that the photocopy should cover a large enough area to extend one mile beyond the property boundary on which the proposed injection well is located. The following information should be included with the topographic map:

- 1) The name and location of the proposed injection well.
- 2) A circle with a ¼ mile radius drawn around the proposed injection well.

It is recommended that the entire AOR be located within property under control of the permittee. An injection well permit can be revoked if a third party drills within the AOR and does not properly case and cement the well.

- 3) The locations of all producing wells, injection wells, and dry holes should be spotted within the AOR. The names of the wells, their permit numbers, and Carter Coordinates should be listed. See Appendix C for an example of this attachment.

- 4) Drinking water supplies and drinking water wells within ¼ mile (1320') from the lease where the proposed well is located. This would include surface springs and other bodies of water. Only information of public record is required.
- 5) **A list of all Surface Landowners and their addresses within the AOR**
Each landowner will be notified by the EPA about your pending UIC permit.
- 6) Location of suspected faults within the AOR (refer to USGS geologic quadrangle map).
- 7) Location of mines and quarries within the AOR
- 8) Provide a lease map, if one is available, with well spots. This is very helpful to the permit reviewer and will speed up the permit process.

If operators do not have their own records, then copies of information of public record are acceptable to complete this attachment.

- **Attachment C – Corrective Action Plan and Well Data**

The purpose for this attachment is to provide the permit reviewer with the information available about those wells within the AOR, which penetrate the proposed injection zone. The information will help the reviewer determine what action may be required of the operator to rework those wells to keep fluid from migrating into USDWs.

List each well, producing, injection, or abandoned, which is located within the AOR and penetrates the injection zone. Attach copies of the completion reports and plugging reports, if available, which are on file at the Kentucky Geological Survey, in Lexington or which may be in your possession. Only wells drilled deep enough to reach the injection zone are necessary for this attachment. However, an operator should list every well and its total depth within the AOR to speed up the permit process.

For improperly plugged wells that are located within the AOR and penetrate the injection zone, a corrective action plan must be submitted. The plan must detail the way by which improperly plugged wells will be re-entered and plugged to prevent the movement of fluids from injection operations into the USDWs.

Wells that lack records may need to be logged and/or plugged. Many permit denials are based on bad records.

If you are not sure you need a corrective plan, then submit all available records to the permit reviewer. EPA will then determine what corrective actions will be needed. Those corrective actions required for fixing the defective wells will be described in a section of your permit titled "Special Conditions".

- **Attachment E – Name and depth of USDWs**

Submit the geologic name and depth of all formations that are underground sources of drinking water (USDWs). If the water in a formation has total dissolved solids of less than 10,000 mg/l, then the formation is a USDW. If USDWs have not been identified for your area, they may be calculated from electric logs. At a minimum, submit logs with your application so the EPA can do the calculation. USGS geologic quadrangles are helpful to identify water resources. EPA can assist you to identify the USDWs.

If your application is for the conversion of a producing well to an injection well, submit geophysical logs from the well if available. If logs are not available, submit logs from a nearby well. If your application is for a well that is to be drilled as an injection well, submit logs from a nearby well. These logs should show the formations that are underground sources for drinking water (USDWs), the proposed injection zone, and the formation that serves as the cap rock (confining zone) above the injection zone.

If geophysical logs are not available, submit drillers' logs.

- **Attachment G – Geological data on injection and confining zones**

Submit data on the injection and confining zone. The rock formation that will receive the injected fluids is the injection zone. The confining zone is a rock formation above the injection zone that will keep injected fluids from escaping upward into formations capable of supplying drinking water. EPA will accept USGS maps and information from KGS to help supply this information. Previously published field studies are very helpful. Include the lithology of the rock (rock type), geological name, thickness, and fracture pressure (the pressure that will crack open a formation). Include reports from previous fracture treatments in the proposed injection zone from this well or nearby wells if they are available.

- **Attachment H – Operating Data**

Submit a proposed daily injection volume in barrels. Submit the proposed average and maximum injection pressure. Describe the type of annular fluid that will fill up the space between the tubing and casing. Typical annular fluids consist of fresh water or brine water with some chemicals added to slow down corrosion of the casing and stop the formation of bacteria.

Describe the source or sources of your injection fluid. Include a chemical analysis of the injected fluid. Take a sample of your injection fluid and have a water lab analyze it for total dissolved solids (TDS), specific gravity, and pH.

- **Attachment M – Construction Details**

Submit a well diagram of the proposed injection well. The diagram should show the above ground and below ground construction of the well. Include the casing size and depth and cement displaced on each string. An example well diagram is shown in Appendix C.

- **Attachment Q – Plugging and abandonment plan (proposal).**

Submit a plan that shows the type and placement of cement plugs in the well, and a cost estimate. Use the EPA cost guidelines as shown below. Use EPA Form 7520-14 for your plan.

EPA would prefer to see a plug from top to bottom, but this proposal can be modified at a later date.

If plugs are to be spotted in the wellbore, be advised that each plug must set up and be tagged before a second plug can be spotted. This procedure could be more expensive due to increased rig time.

EPA Estimated Cost to Depth Guidelines

Well Depth*	Cement Top Behind Casing**		
	<u>At Surface</u>	<u>Below Surface</u>	
< 500'	\$2300	\$3000	
501'-1000'	\$3000	\$3900	
1001'-1500'	\$3700	\$5000	
1500'-2000'	\$4800	\$6500	*Refers to Plug Back Depth
>2000'	\$5800	\$7400	**Production Casing String

- **Attachment R – Necessary Resources - Financial Responsibility Requirements**

EPA requires that operators have enough money set aside to plug each injection well. Operators have the option to obtain a minimum of three bids. In lieu of acquiring bids, the amount of money required will be the cost estimate on Attachment Q calculated from the EPA estimated cost guidelines shown above. This money must be pledged to plug the well. Several types of financial instruments and trust agreements are available which are acceptable to the EPA. Since many small operators have limited financial resources, they may not qualify for some of these financial instruments. EPA will work with your bank directly to help you get this attachment satisfied.

EPA has prepared forms for each type of financial instrument and trust agreement. Copies of these forms are provided in Appendix B. Several EPA approved financial instruments are listed below in order from the easiest to the most difficult to obtain and meet EPA approval.

Option 1. Obtain an Irrevocable Letter of Credit from your bank with a Stand By Trust Agreement. Your bank may require some form of financial backing such as a certificate of deposit. With this financial arrangement, the operator will be allowed to use any interest that accumulates. This is the most common financial arrangement used by operators.

Option 2. Set up a fully funded trust with your bank. Your bank may require some form of financial backing such as a certificate of deposit. With this financial arrangement, all interest earned is kept within the trust.

Option 3. Obtain a Surety Performance Bond by an insurance company and execute a Stand By Trust Agreement.

Option 4. Prepare a Financial Statement and Chief Financial Officer's Letter. Include an Independent Auditor's Verification Statement. This option is typically reserved for Fortune 500 companies. The financial statements must be updated each year with the EPA.

EPA has provided sample forms for these financial instruments. The permitting process will be shortened if these sample forms are used. Provide photocopies of CD's with application.

- **Attachment U – Nature of business**

Submit a brief description about your business. Example language is as follows: "XYZ Oil Company is involved in exploration, production, and marketing crude oil and natural gas."

- **Class II Permit Application Exhibits**

The appendix to the application should include copies of the maps, diagrams, and reports described in the attachments.

EPA Permit Review & Response

After the application is received, the EPA will perform a technical review of your permit application. They will check for completeness, so it is highly recommended that your permit application include all of the attachments listed above. Any parts that are missing will cause unnecessary delays. Once the permit has been reviewed and determined to be complete, the EPA will issue a draft permit to the operator and will issue a public notification of the draft permit. The review and drafting of the permit by the EPA will take a minimum of 30 days. There will be a 30-day public comment period. The public notice goes out to all landowners within the AOR, and individuals and organizations on the EPA public notice mailing list. The operator will receive the draft permit, a statement of basis, and a copy of the public notice. The cover letter will advise that the operator will have 25 days to comment on the draft permit. Typing errors and other errors are usually fixed at this time. The operator will be notified of any public comment that might cause a change in the permit requirements. If the draft permit is altered significantly, additional public notice may be necessary. The operator is not responsible to supply this public notification.

Example permits and related correspondence is provided in Appendix C.

Common Reasons Permits are Denied

Permit rejections are often the result of one or more of the following:

1. The permit application is not complete.
2. The proposed well is located in a geologically faulted area.
3. The operator is unable to meet the financial responsibility requirement.

Modifications: Permits will be issued on the basis of submitted data. The permit will specify certain requirements. A permit modification will be needed if the operator must change the original requirements. Examples of such changes include new sources of the injected water and/or increases in injection pressure above the permitted limits.

Permit Application – Kentucky Division of Oil & Gas

If an operator intends to drill an injection well, then a permit must also be obtained from the Division of Oil and Gas prior to the spudding. The DOG permit application requirements for drilling an injection well are the same as for any other oil or gas well. Procedures for obtaining a permit can be found in the Oil and Gas Well Operators Manual. Copies of this manual may be obtained from the Division of Oil and Gas in Lexington, Kentucky.

If an operator intends to convert an existing production well into an injection well, the operator will not need a new permit, however the well must be under the operator's bond, and must be listed with the Division.

Section 2. New Well Construction & Well Conversion

Construction Requirements

The EPA classifies a "new" UIC well as any well drilled as an injection well or converted from producing well to an injection well after June 25, 1984. New wells must be constructed in certain ways in order to be permitted as injection wells under the UIC Class II program. These construction requirements are:

- All new wells must have their casing cemented in place to protect drinking water formations and to isolate the injection zone. For newly drilled wells, the casing must be cemented from the surface to below the lowermost drinking water formation. The grade of casing and quality of cement must be sufficient to protect the drinking water formations, isolate the injection zone, and last for the life of the well. The simple rule of thumb is that your casing and cementing must be capable of passing the MIT.
- Casing should be set and cemented in place as close to your injection zone as possible.
- During drilling and completion, the EPA defers to DOG authority for BOP's, sample requirements, etc.
- If cement does not return to surface during the process of cementing well casing, a cement bond log maybe required to be run.
- Copies of geophysical well logs must be submitted to the EPA if they are run. Running geophysical logs is not a requirement of the EPA. However, it is highly recommended that these logs be run. The logs will help the operator complete the well and inject into the proper injection zone.

Tubing & Packer

- All injection for new Class II wells must be through tubing and packer. Good quality tubing and a tension packer must be run in the well. If the injected fluid is corrosive, it is suggested that internally coated or fiberglass tubing be used.
- A tubing head should be placed on top of the casing so the annular space between the tubing and casing can have pressure applied to it for mechanical integrity testing. The tubing head will allow the annular space to be monitored for pressure changes during the life of the well.
- Packers must always be set in casing to within 100' of the injection zone.
- The annular space between the tubing and casing should be filled with water or other fluid as approved by the EPA. The required pressure on this fluid at the surface should remain at 0 psig. A pressure gauge that reads both positive and negative pressure should be used to monitor this space.

Section 3. Mechanical Integrity Tests

What is a Mechanical Integrity Test?

A Mechanical Integrity Test, or MIT, is a pressure test performed on every injection well to determine that no significant fluid is leaking through the well casing, tubing or packer into formations which may be sources of drinking water. The MIT is designed to test the entire system including the tubing, packer, and well head. The test is performed by applying pressure to the space between the casing and the tubing for a period of 30 minutes. If a pressure drop is observed that causes the well to fail the test, then the casing, tubing or packer, or wellhead has developed a leak. The leak must be fixed and the test retaken.

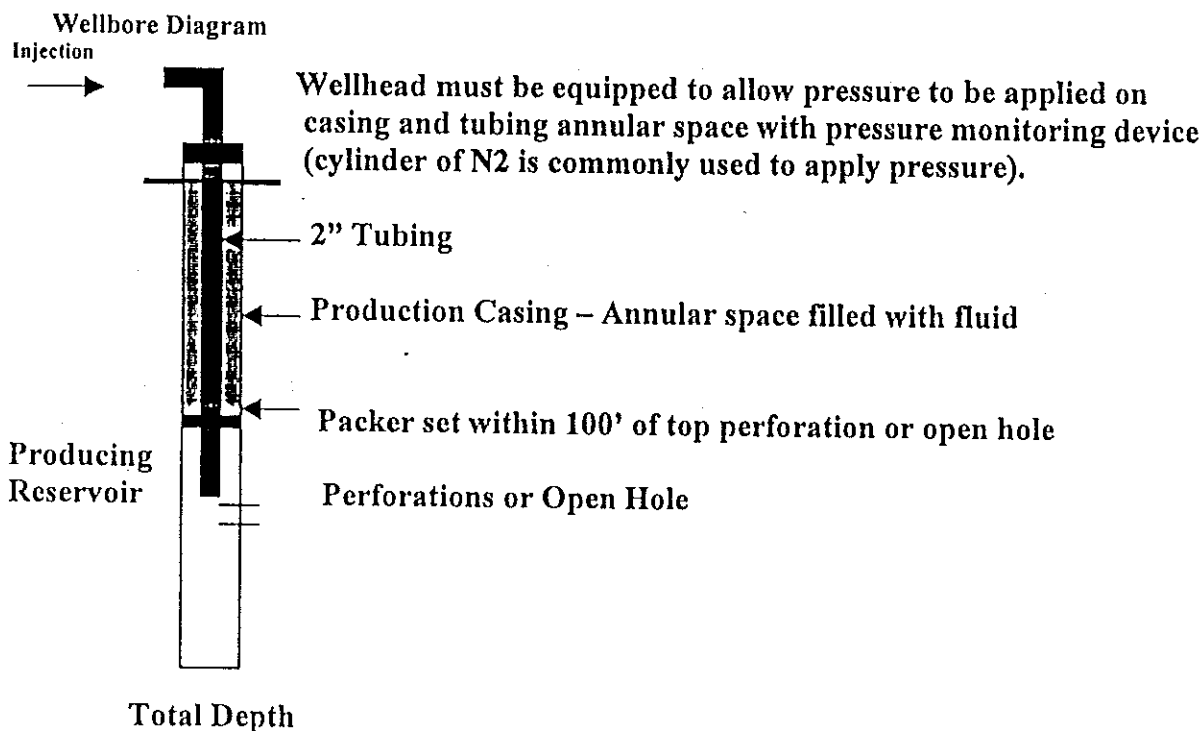

MIT Testing Procedure

1. Give forty-five (45) day advance notice to EPA so an inspector can be scheduled. EPA will send out a certified letter to the operator with the time and date of the test. The letter will have contacts and phone numbers.
2. Insure the packer is properly set in casing at the depth specified in the permit. Fill annular space with fluid. Air should be totally displaced.
3. Check all valves, secure tubing, and insure all leaks are repaired.
4. With inspector on location, apply pressure on tubing annular space.(usually with nitrogen-N2). Oxygen should not be used because of safety concerns.
5. Apply a minimum 300-pound pressure on tubing annulus for 30 minutes. The EPA representative will monitor pressure variations at the time of the test. Pressure changes cannot exceed 3% above or below the applied pressure (9 pounds per 300 pounds of applied pressure).

When Are MITs Required?

MITs are Required:

1. Before any new well or newly converted well is placed into service
2. After any workover that resets the packer
3. For any well where the packer becomes unseated
4. Every 5 years for active standard injection wells (injection through tubing and packer)
5. Every 2 years for non-standard wells (old rule authorized wells that inject through production casing)
6. Every 2 years for idle or temporary abandoned wells. These wells have remained fully equipped and could be started back up with the flip of a switch but have been shut-in for 2 years
7. Every 2 years for abandoned wells with tubing and packer removed. A plug may be set and the casing is pressured up to 300 pounds.
8. Prior to a conversion from injection to production, a well must pass an MIT.

Section 4. Well Operation & Reporting

When Can Injection Begin?

Injection can not begin until the construction of the well has been completed according to Attachment M of the permit application, the MIT has been performed and passed, and the "Completion Report for Brine Disposal, HC Storage, or Enhanced Recovery Wells" has been sent to the EPA. All corrective action within the AOR must also have been performed. Upon review of all of these requirements and approval by EPA, the operator may begin injection.

Preparing a Completion Report for Brine Disposal, HC Storage, or Enhanced Recovery Wells

Upon successful construction and testing of the permitted injection well, the operator must fill out EPA Form 7520-10, the "Completion Report for Brine Disposal, HC Storage, or Enhanced Recovery Wells". Include with this form the following attachments listed on the back of the form:

- **Attachment A** is a drawing of the surface and subsurface construction of the well. The construction should follow the plans presented in "Attachment M" of the permit application.
- **Attachment B** - describe the methods and result of the mechanical integrity test.
- **Attachment C** - provide information on any logs, tests, or cores taken on any USDW, confining zone, or injection zone.
- **Attachment D** - provide information on the progress of the corrective action taken on defective wells in the area of review. The "Special Conditions" section of the permit will list the requirements for fixing the defective wells.
- **Attachment E** - provide a copy of the Kentucky Division of Oil & Gas completion report and a copy of all logs run on the well.

The completion report and the attachments should be sent to EPA Region 4 by certified mail, return receipt requested. The EPA will send a notice to the operator within 13 days of the receipt of the completion form, of its review of the report, and whether the operator has satisfied the conditions of the permit. These conditions include passing the MIT and completing all of the necessary corrective action. If the review is favorable, the operator will receive authorization to start injection.

If the MIT has passed and the corrective action completed, but the operator has not received notice or authorization by the EPA within 13 days of its receipt of the completion report, the operator can assume the conditions of the permit have been met, and injection can begin.

Operations

Only fluids brought to the surface in connection with oil and gas production may be injected. Other permitted fluids would include make-up water for secondary recovery, and fluids used in other enhanced recovery operations which inject polymer, CO₂, gas, or air. When in doubt, contact the EPA.

If mechanical integrity is lost, injection must cease, the operator must correct the problem and have a MIT performed on the well before injection may resume.

All records for the well must be kept a minimum of three (3) years.

Sampling Requirements

Operators of Class II injection wells must monitor the amount of fluid injected and the pressure at which the fluid is injected on a regular basis. For enhanced recovery wells, the average and maximum injection pressure, the total volume of fluid in barrels or MCF (thousand cubic feet), and the minimum and maximum casing pressure, should be measured and recorded on a monthly basis. For disposal wells, these measurements need to be taken and recorded on a weekly basis. The measurements can be taken at a common manifold for injection wells in the same field.

An injection fluid analysis should be taken within 12 months from the date the permit was issued, and every 12 months thereafter, or if significant changes in fluid composition occur. Adding water from a new producing formation might constitute a significant change in composition. If there is a significant change, contact EPA. The analysis must measure pH, total dissolved solids, and specific gravity. The analysis must also include the names and chemical composition of all chemicals used for well stimulation, and any additives or inhibitors used to prevent scaling, corrosion, and bacterial growth. The EPA may require measurements for other chemicals in the injected fluid.

The annular space between the casing and tubing should be monitored for each injection well. If the pressure rises or lowers by 15 psig, the operator shall provide an explanation to the EPA and take steps to correct the problem. If the problem is not corrected in 48 hours, injection must stop unless the EPA allows it to continue.

Reporting Requirements

An "Annual Disposal/Injection Well Monitoring Report", EPA Form 7520-11, must be submitted each year on the 28th of the month following the anniversary of the effective date of the permit. "Rule Authorized" well reports are due every October. The report consists of the pressure and volume measurements taken and recorded by the operator as described in the "Sampling Requirement" section above.

Copies of this and other reports that are required by the EPA should be sent to the following address:

U.S. Environmental Protection Agency – Region 4
Ground Water & UIC Section
Atlanta Federal Center
61 Forsyth Street
Atlanta, Georgia 30303-3104

Workovers

The operator must notify the EPA within 90 days of any well workover, logging, or testing that may reveal downhole conditions. The operator should submit a "Well Rework Record", EPA Form 7520-12 documenting the activity within thirty days following the completion of the rework. If the packer becomes unseated during the workover, a MIT must be conducted. Notify EPA 30 days in

advance of the test, and follow the same procedures as described in the Section III on MITs. Injection must be halted until the well passes the MIT.

Division of Oil & Gas

The Kentucky Division of Oil and Gas requires that an "Affidavit of Well Log and Completion Report", form ED-3, be submitted within 90 days from the date a newly drilled injection well is completed. In addition the operator must submit a "Certificate of Completion for an Injection Well" form ED-23. This form will require information on the tubing, packer, setting depth, injection pressure, and monitoring procedure.

If the injection well is converted from an existing production well, only the "Certificate of Completion for an Injection Well" needs to be submitted with copies of any new down-hole logs and surveys not previously filed with D O G.

DISPOSAL ALTERNATIVES

Division of Water

The Kentucky Natural Resources and Environmental Protection Cabinet and its Division of Water (DOW) regulates the disposal of produced water by methods other than through an operator's permitted UIC Class II well.

Operators have the option of taking their produced water offsite to a disposal facility. DOW has a one page form, titled "Application to Dispose of Produced Water Off-Facility" for this purpose. This is a one time filing for water being transported from a single facility offsite to an approved UIC injection facility. If ownership or conditions change at the receiving facility, the form may need to be resubmitted.

Operators also have the option of disposing produced water by surface discharge. An operator would need to obtain a KPDES permit from DOW to do so.

For additional information on these disposal options, refer to the Oil and Gas Well Operator's Manual.

Section 5. Permit Transfers

Injection wells may be transferred to other operators, however those transfers need to be approved by the EPA, the DOG, and the DOW.

Before any transfer of ownership is allowed, the EPA must be notified, and an "Application to Transfer Permit EPA Form 7520-7" must be completed. A lease assignment and/or sale agreement must also be submitted. The new operator must establish financial responsibility with the EPA before the transfer will be approved. Once the transfer has been approved, the liability will change to the new operator, and the EPA will release the previous owner from financial responsibility. Upon receipt of transfer approval, the new operator may begin to operate the injection well(s). The modified permit that shows the change of ownership will be mailed to the new operator.

The new operator is responsible for maintaining the same MIT and monitoring report schedule that the previous owner followed.

Change of ownership is not complete until the DOG & DOW transfers have taken place. The DOG requires that each well be listed on its "Well Transfer" form #ED-13. A \$25 fee for each well must accompany the form. In addition, the new operator must bond each well with the DOG. Once the new owner's bond is in place, the previous owner's bond may be released.

The DOW also requires a "Transfer of Ownership" form to be completed. In addition, each tank battery must be registered in the new owner's name. A registration form must be filled out and signed by the new owner for each facility.

Though not a requirement it is always a good idea for the new operator to get all of the data and records possible from the previous operator.

Section 6. Emergency Notification Procedures

The EPA must be notified if any malfunction or emergency occurs at a permitted facility. The operator must notify the EPA:

1. If an operator determines a malfunction has occurred
2. When monitoring indicates a contaminant may endanger the USDW
3. When noncompliance with a permit condition occurs

An Oral report must be given within 24 hours from the time the operator becomes aware there is a problem. For notification call: 404-562-9743

A written report must be given within 5 days from the time the owner becomes aware there is a problem.

The operator must contain and clean-up any spills, leaks, discharges, or releases of pollutants immediately. For reportable spills, notify Kentucky's Environmental Response Team at 1-800-928-2380.

Section 7. Abandonment and Closure

The plugging of your Class II well must be coordinated with both DOG and EPA.

Contact the EPA in Atlanta and submit a plugging plan on EPA Form 7520-14 if your plan is different from the original plugging plan on Attachment Q in your permit application. EPA will notify the operator that the plan has been approved and will notify the local EPA inspector.

The most acceptable plan from EPA's standpoint is setting a continuous cement plug from top to bottom. If separate plugs are desired to be set, the plan may be more complicated to coordinate with Division of Oil & Gas inspector. Also, each plug will have to set up and be tagged before the next plug is set.

The EPA inspector and DOG inspector may be on sight during plugging. The DOG inspector must be informed of the plugging date so he may be present.

After the well is plugged, the EPA inspector will provide documentation to the Atlanta office. However, the operator is encouraged to send a copy of the plugging report to the EPA permit section to help expedite the bond release. The EPA bond will then be released back to the operator.

Submit a plugging affidavit with the Division of Oil & Gas to receive a bond release.

APPENDIX A

Glossary of Terms	A-1
Kentucky Regulatory Offices	A-3
MIT Inspector	A-3
Federal Regulatory Offices	A-4

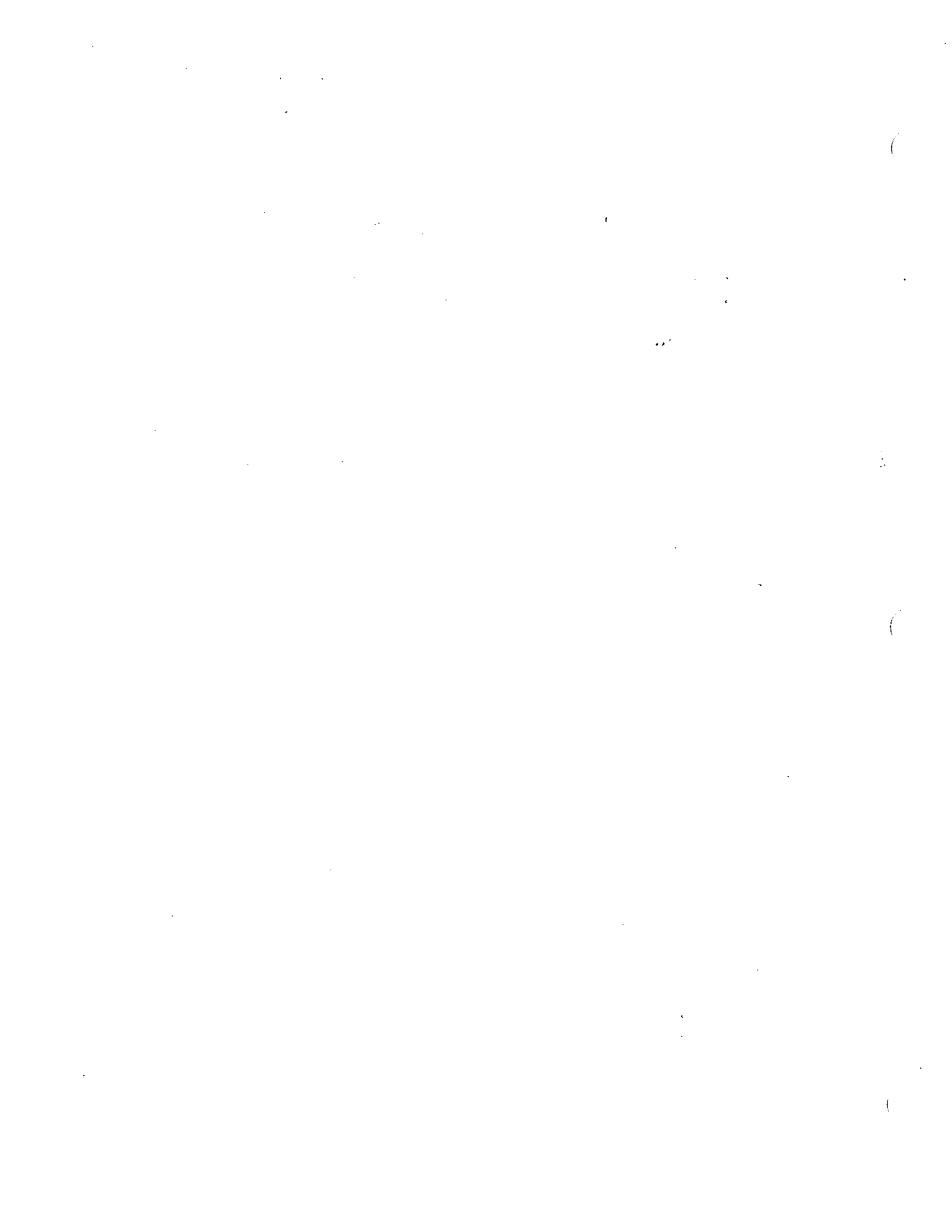

GLOSSARY OF TERMS

Aquifer – a geologic formation capable of yielding a significant amount of water to a well or spring.

Class II Wells – wells which inject fluids

- A) which are brought to the surface in connection with conventional oil or natural gas production and may be commingled with waste waters from gas plants which are an integral part of production operations, unless those waters would be classified as hazardous waste at the time of injection.
- B) for enhanced recovery of oil or natural gas; and
- C) for storage of hydrocarbons which are liquid at standard temperature and pressure.

New Class II Wells – wells constructed or converted after the effective date of the UIC program

Confining bed – impermeable rock adjacent to one or more aquifers

Confining zone – a geologic formation, group of formations, or a part of a formation that is capable of limiting fluid movement above an injection zone.

Contaminant – any physical, chemical, biological, or radiological substance or matter in water.

Disposal well – a well used for the disposal of waste into a subsurface stratum

EPA – The United States Environmental Protection Agency

Fault – a surface or zone of rock fracture along which there has been displacement

Fluid – material or substance which moves or flows whether in a semisolid, liquid, sludge, gas or any other form or state

Formation – a body of rock characterized by a degree of lithologic homogeneity which is prevailing, but not necessarily tabular and is mapable on the earth's surface or in the subsurface

Fresh water – “Underground source of drinking water”

Ground Water – water below the land surface in a zone of saturation

Injection well – a well into which fluids are injected

Lithology – the description of rocks on the basis of their physical and chemical characteristics

Make-Up Water – Fresh water plus additives added to produced water to increase injection volume for enhanced recovery.

Owner/Operator – the owner or operator of any facility or activity subject to regulation under the UIC program

Packer – a device lowered into a well to produce a fluid-tight seal within the casing or wellbore

Permit – an authorization issued by the EPA to implement UIC program requirements.

Plugging – the act or process of stopping the flow of water, oil or gas into or out of a formation through a borehole or well penetrating that formation

Pressure – the total load or force per unit area acting on a surface

Regional Administrator – the Regional Administrator of Region 4 of the U.S. Environmental Protection Agency

Underground Source of Drinking Water – an aquifer or its portion

- a) (1) that supplies any public water system
- (2) that contains a sufficient quantity of ground water to supply a public water system
- (3) is currently a supply of drinking water for human consumption
- (4) that contains fewer than 10,000 mg/l total dissolved solids; and
- b) which is not an exempted aquifer

USDW – Underground source of drinking water

Well – a bored, drilled, or driven shaft, or dug hole whose depth is greater than the largest surface dimension

Well Injection – the subsurface emplacement of fluid through a well

Well Workover – any reentry of an injection well; including but not limited to, the pulling of tubular goods, cementing & casing repairs

KENTUCKY REGULATORY OFFICES

Division of Oil and Gas
Post Office Box 14090
Lexington, Kentucky 40512-4090

(606) 246-2032

Division of Water
14 Reilly Road
Frankfort, Kentucky 40601

(502) 564-2225

MIT Inspector:

David Hays
TSA, Inc.
598 College Street
Winchester, Kentucky 40391

(606) 737-3641

FEDERAL REGULATORY OFFICES

U.S. Environmental Protection Agency – Region 4
Ground Water & UIC Section
Atlanta Federal Center
61 Forsyth Street
Atlanta GA 30303-3104

(404) 562-9743

APPENDIX B

FORMS

Underground Injection Control Permit Application.....	B 1
Financial Responsibility Forms.....	B 7
Bank Irrevocable Letter of Credit.....	B-9
Standby Trust Agreement.....	B-12
Trust Agreement.....	B-21
Surety Performance Bond.....	B-31
Chief Financial Officers Letter.....	B-35
Auditor's Verification of Chief Financial Officer's Letter.....	B-39
Completion Report for Brine Disposal, HC Storage, or Enhanced Recovery Wells EPA Form 7520-10.....	B-40
Certificate of Completion for an Injection Well – DOG Form ED-23.....	B-41
Plugging and Abandonment Plan – EPA Form 7520-14.....	B-42
Application to Transfer Permit – EPA Form 7520-7.....	B-43
Well Rework Record – EPA Form 7520-12.....	B-44
Annual Disposal / Injection Well Monitoring Report – EPA Form 7520-11.....	B-45





United States Environmental Protection Agency
Underground Injection Control
Permit Application
(Collected under the authority of the Safe Drinking Water Act, Sections 1421, 1422, 40 CFR 144)

I. EPA ID Number		
	T/A	C
U		

Read Attached Instructions Before Starting
For Official Use Only

Application approved mo day year	Date received mo day year	Permit Number	Well ID	FINDS Number

II. Owner Name and Address				III. Operator Name and Address			
Owner Name				Operator Name			
Street Address			Phone Number	Street Address			Phone Number
City		State	ZIP CODE	City		State	ZIP CODE

IV. Commercial Facility	V. Ownership	VI. Legal Contact	VII. SIC Codes
<input type="checkbox"/> Yes <input type="checkbox"/> No	<input type="checkbox"/> Private <input type="checkbox"/> Federal <input type="checkbox"/> Other	<input type="checkbox"/> Owner <input type="checkbox"/> Operator	

VIII. Well Status (Mark "x")			
<input type="checkbox"/> A. Operating	Date Started mo day year	<input type="checkbox"/> B. Modification/Conversion	<input type="checkbox"/> C. Proposed

IX. Type of Permit Requested (Mark "x" and specify if required)			
<input type="checkbox"/> A. Individual	<input type="checkbox"/> B. Area	Number of Existing Wells	Number of Proposed Wells
Name(s) of field(s) or project(s)			

X. Class and Type of Well (see reverse)			
A. Classes(es) (enter codes(s))	B. Type(s) (enter codes(s))	C. If class is "other" or type is code "x," explain	D. Number of wells per type (if area permit)

XI. Location of Well(s) or Approximate Center of Field or Project												XII. Indian Lands (Mark "x")				
Latitude			Longitude			Township and Range										<input type="checkbox"/> Yes <input type="checkbox"/> No
Deg	Min	Sec	Deg	Min	Sec	Sec	Twp	Range	1/4 Sec	Feet From	Line	Feet From	Line			

XIII. Attachments

(Complete the following questions on a separate sheet(s) and number accordingly; see instructions)
 For Classes I, II, III, (and other classes) complete and submit on a separate sheet(s) Attachments A-U (pp 2-6) as appropriate. Attach maps where required. List attachments by letter which are applicable and are included with your application.

XIV. Certification			
I certify under the penalty of law that I have personally examined and am familiar with the information submitted in this document and all attachments and that, based on my inquiry of those individuals immediately responsible for obtaining the information, I believe that the information is true, accurate, and complete. I am aware that there are significant penalties for submitting false information, including the possibility of fine and imprisonment. (Ref. 40 CFR 144.32)			
A. Name and Title (Type or Print)			B. Phone No. (Area Code and No.)
C. Signature			D. Date Signed

Well Class and Type Codes

Class I	Wells used to inject waste below the deepest underground source of drinking water.
Type "I"	Nonhazardous industrial disposal well
"M"	Nonhazardous municipal disposal well
"W"	Hazardous waste disposal well injecting below USDWs
"X"	Other Class I wells (not included in Type "I," "M," or "W")
Class II	Oil and gas production and storage related injection wells.
Type "D"	Produced fluid disposal well
"R"	Enhanced recovery well
"H"	Hydrocarbon storage well (excluding natural gas)
"X"	Other Class II wells (not included in Type "D," "R," or "H")
Class III	Special process injection wells.
Type "G"	Solution mining well
"S"	Sulfur mining well by Frasch process
"U"	Uranium mining well (excluding solution mining of conventional mines)
"X"	Other Class III wells (not included in Type "G," "S," or "U")
Other Classes	Wells not included in classes above.
	Class V wells which may be permitted under §144.12
	Wells not currently classified as Class I, II, III, or V.

Attachments to Permit Application

Class	Attachments
I new well	A, B, C, D, F, H — S, U
existing	A, B, C, D, F, H — U
II new well	A, B, C, E, G, H, M, Q, R; optional — I, J, K, O, P, U
existing	A, E, G, H, M, Q, R — U; optional — J, K, O, P, Q
III new well	A, B, C, D, F, H, I, J, K, M — S, U.
existing	A, B, C, D, F, H, J, K, M — U
Other Classes	To be specified by the permitting authority

INSTRUCTIONS - Underground Injection Control (UIC) Permit Application

PAPERWORK REDUCTION ACT NOTICE

Public reporting burden for this collection of information is estimated at an average of 255 hours for Class I wells, 16 hours for Class II wells, and 200 hours for Class III wells per application, including time for reviewing instructions, searching existing data sources, gathering and maintaining the data needed, and completing and reviewing the collection of information. Send comments regarding the burden estimate or any aspect of this collection of information, including suggestions for reducing this burden, to Chief, Information Policy Branch, PM-223, U.S. Environmental Protection Agency, 401 M Street, SW, Washington, DC 20460, and to the Office of Management and Budget, Paperwork Reduction Project, Washington, DC 20503.

This form must be completed by all owners or operators of Class I, II, and III Injection wells and others who may be directed to apply for permit by the Director.

- I. EPA I.D. NUMBER - Fill in your EPA Identification Number. If you do not have a number, leave blank.
- II. OWNER NAME AND ADDRESS - Name of well, well field or company and address.
- III. OPERATOR NAME AND ADDRESS - Name and address of operator of well or well field.
- IV. COMMERCIAL FACILITY - Mark the appropriate box to indicate the type of facility.
- V. OWNERSHIP - Mark the appropriate box to indicate the type of ownership.
- VI. LEGAL CONTACT - Mark the appropriate box.
- VII. SIC CODES - List at least one and no more than four Standard Industrial Classification (SIC) Codes that best describe the nature of the business in order of priority.
- VIII. WELL STATUS - Mark Box A if the well(s) were operating as injection wells on the effective date of the UIC Program for the State. Mark Box B if wells(s) existed on the effective date of the UIC Program for the State but were not utilized for injection. Box C should be marked if the application is for an underground injection project not constructed or not completed by the effective date of the UIC Program for the State.
- IX. TYPE OF PERMIT - Mark "Individual" or "Area" to indicate the type of permit desired. Note that area permits are at the discretion of the Director and that wells covered by an area permit must be at one site, under the control of one person and do not inject hazardous waste. If an area permit is requested the number of wells to be included in the permit must be specified and the wells described and identified by location. If the area has a commonly used name, such as the "Jay Field," submit the name in the space provided. In the case of a project or field which crosses State lines, it may be possible to consider an area permit if EPA has jurisdiction in both States. Each such case will be considered individually, if the owner/operator elects to seek an area permit.
- X. CLASS AND TYPE OF WELL - Enter in these two positions the Class and type of injection well for which a permit is requested. Use the most pertinent code selected from the list on the reverse side of the application. When selecting type X please explain in the space provided.
- XI. LOCATION OF WELL - Enter the latitude and longitude of the existing or proposed well expressed in degrees, minutes, and seconds or the location by township, and range, and section, as required by 40 CFR Part 146. If an area permit is being requested, give the latitude and longitude of the approximate center of the area.
- XII. INDIAN LANDS - Place an "X" in the box if any part of the facility is located on Indian lands.
- XIII. ATTACHMENTS - Note that information requirements vary depending on the injection well class and status. Attachments for Class I, II, III are described on pages 4 and 5 of this document and listed by Class on page 2. Place EPA ID number in the upper right hand corner of each page of the Attachments.
- XIV. CERTIFICATION - All permit applications (except Class II) must be signed by a responsible corporate officer for a corporation, by a general partner for a partnership, by the proprietor of a sole proprietorship, and by a principal executive or ranking elected official for a public agency. For Class II, the person described above should sign, or a representative duly authorized in writing.

INSTRUCTIONS - Attachments

Attachments to be submitted with permit application for Class I, II, III and other wells.

- A. **AREA OF REVIEW METHODS** - Give the methods and, if appropriate, the calculations used to determine the size of the area of review (fixed radius or equation). The area of review shall be a fixed radius of 1/4 mile from the well bore unless the use of an equation is approved in advance by the Director.
- B. **MAPS OF WELL/AREA AND AREA OF REVIEW** - Submit a topographic map, extending one mile beyond the property boundaries, showing the injection well(s) or project area for which a permit is sought and the applicable area of review. The map must show all intake and discharge structures and all hazardous waste treatment, storage, or disposal facilities. If the application is for an area permit, the map should show the distribution manifold (if applicable) applying injection fluid to all wells in the area, including all system monitoring points. Within the area of review, the map must show the following:

Class I

The number, or name, and location of all producing wells, injection wells, abandoned wells, dry holes, surface bodies of water, springs, mines (surface and subsurface), quarries, and other pertinent surface features, including residences and roads, and faults, if known or suspected. In addition, the map must identify those wells, springs, other surface water bodies, and drinking water wells located within one quarter mile of the facility property boundary. Only information of public record is required to be included in this map;

Class II

In addition to requirements for Class I, include pertinent information known to the applicant. This requirement does not apply to existing Class II wells;

Class III

In addition to requirements for Class I, include public water systems and pertinent information known to the applicant.

- C. **CORRECTIVE ACTION PLAN AND WELL DATA** - Submit a tabulation of data reasonably available from public records or otherwise known to the applicant on all wells within the area of review, including those on the map required in B, which penetrate the proposed injection zone. Such data shall include the following:

Class I

A description of each well's types, construction, date drilled, location, depth, record or plugging and/or completion, and any additional information the Director may require. In the case of new injection wells, include the corrective action proposed to be taken by the applicant under 40 CFR 144.55.

Class II

In addition to requirement for Class I, in the case of Class II wells operating over the fracture pressure of the injection formation, all known wells within the area of review which penetrate formations affected by the increase in pressure. This requirement does not apply to existing Class II wells.

Class III

In addition to requirements for Class I, the corrective action proposed under 40 CFR 144.55 for all Class III wells.

- D. **MAPS AND CROSS SECTION OF USDWs** - Submit maps and cross sections indicating the vertical limits of all underground sources of drinking water within the area of review (both vertical and lateral limits for Class I), their position relative to the injection formation and the direction of water movement, where known, in every underground source of drinking water which may be affected by the proposed injection. (Does not apply to Class II wells.)

- E. **NAME AND DEPTH OF USDWs (CLASS II)** - For Class II wells, submit geologic name, and depth to bottom of all underground sources of drinking water which may be affected by the injection.
- F. **MAPS AND CROSS SECTIONS OF GEOLOGIC STRUCTURE OF AREA** - Submit maps and cross sections detailing the geologic structure of the local area (including the lithology of injection and confining intervals) and generalized maps and cross sections illustrating the regional geologic setting. (Does not apply to Class II wells.)
- G. **GEOLOGICAL DATA ON INJECTION AND CONFINING ZONES (Class II)** - For Class II wells, submit appropriate geological data on the injection zone and confining zones including lithologic description, geological name, thickness, depth and fracture pressure.
- H. **OPERATING DATA** - Submit the following proposed operating data for each well (including all those to be covered by area permits): (1) average and maximum daily rate and volume of the fluids to be injected; (2) average and maximum injection pressure; (3) nature of annulus fluid; (4) for Class I well, source and analysis of the chemical, physical, radiological and biological characteristics, including density and corrosiveness, of injection fluids; (5) for Class II wells, source and analysis of the physical and chemical characteristics of the injection fluid; (6) for Class III wells, a qualitative analysis and ranges in concentrations of all constituents of injected fluids. If the information is proprietary, maximum concentrations only may be submitted, but all records must be retained.
- I. **FORMATION TESTING PROGRAM** - Describe the proposed formation testing program. For Class I wells the program must be designed to obtain data on fluid pressure, temperature, fracture pressure, other physical, chemical, and radiological characteristics of the injection matrix and physical and chemical characteristics of the formation fluids.

For Class II wells the testing program must be designed to obtain data on fluid pressure, estimated fracture pressure, physical and chemical characteristics of the injection zone. (Does not apply to existing Class II wells or projects.)

For Class III wells the testing must be designed to obtain data on fluid pressure, fracture pressure, and physical and chemical characteristics of the formation fluids if the formation is naturally water bearing. Only fracture pressure is required if the program formation is not water bearing. (Does not apply to existing Class III wells or projects.)
- J. **STIMULATION PROGRAM** - Outline any proposed stimulation program
- K. **INJECTION PROCEDURES** - Describe the proposed injection procedures including pump, surge, tank, etc.
- L. **CONSTRUCTION PROCEDURES** - Discuss the construction procedures (according to §146.12 for Class I, §146.22 for Class II, and §146.32 for Class III) to be utilized. This should include details of the casing and cementing program, logging procedures, deviation checks, and the drilling, testing and coring program, and proposed annulus fluid. (Request and submission of justifying data must be made to use an alternative to packer for Class I.)
- M. **CONSTRUCTION DETAILS** - Submit schematic or other appropriate drawings of the surface and subsurface construction details of the well.
- N. **CHANGES IN INJECTED FLUID** - Discuss expected changes in pressure, native fluid displacement, and direction of movement of injection fluid. (Class III wells only.)
- O. **PLANS FOR WELL FAILURES** - Outline contingency plans (proposed plans, if any, for Class II) to cope with all shut-ins or wells failures, so as to prevent migration of fluids into any USDW.
- P. **MONITORING PROGRAM** - Discuss the planned monitoring program. This should be thorough, including maps showing the number and location of monitoring wells as appropriate and discussion of monitoring devices, sampling frequency, and parameters measured. If a manifold monitoring program is utilized, pursuant to §146.23(b)(5), describe the program and compare it to individual well monitoring.
- Q. **PLUGGING AND ABANDONMENT PLAN** - Submit a plan for plugging and abandonment of the well including: (1) describe the type, number, and placement (including the elevation of the top and bottom) of plugs to be used; (2) describe the type, grade, and quantity of cement to be used; and (3) describe the method to be used to place plugs, including the method used to place the well in a state of static equilibrium prior to placement of the plugs. Also for a Class III well that underlies or is in an exempted aquifer, demonstrate adequate protection of USDWs. Submit this information on EPA Form 7520-14, Plugging and Abandonment Plan.

- R. **NECESSARY RESOURCES** - Submit evidence such as a surety bond or financial statement to verify that the resources necessary to close, plug or abandon the well are available.
- S. **AQUIFER EXEMPTIONS** - If an aquifer exemption is requested, submit data necessary to demonstrate that the aquifer meets the following criteria: (1) does not serve as a source of drinking water; (2) cannot now and will not in the future serve as a source of drinking water; and (3) the TDS content of the ground water is more than 3,000 and less than 10,000 mg/l and is not reasonably expected to supply a public water system. Data to demonstrate that the aquifer is expected to be mineral or hydrocarbon production, such as general description of the mining zone, analysis of the amenability of the mining zone to the proposed method, and time table for proposed development must also be included. For additional information on aquifer exemptions, see 40 CFR Sections 144.7 and 146.04.
- T. **EXISTING EPA PERMITS** - List program and permit number of any existing EPA permits, for example, NPDES, PSD, RCRA, etc.
- U. **DESCRIPTION OF BUSINESS** - Give a brief description of the nature of the business.

FINANCIAL RESPONSIBILITY REQUIREMENTS
Plugging and Abandonment Costs

In accordance with 40 CFR Sections 144.52(a) and 146.24(a) for permitted Class II wells or those wells for which a UIC permit is being applied for, and Section 144.28(d), for rule authorized wells, the owner or operator is required to establish and maintain financial resources to plug and abandon the injection facility in a manner prescribed by the Environmental Protection Agency (EPA). The amount of funds required by an owner or operator to satisfy EPA's financial responsibility requirements has been determined as outlined in the following paragraphs and presented in the attached schedule.

For the purpose of establishing the amount of funds necessary to properly plug and abandon an injection facility, the wells are divided into five (5) depth categories depending on whether or not the primary protective string of casing is cemented to surface. Costs developed for each category were determined by breaking operational charges into five (5) phases as follows:

- (1) Rig/Pulling Unit - includes hourly rate and associated labor costs.
- (2) Cement Services - includes pumping unit, tank truck, and cement costs.
- (3) Site Preparation - includes backhoe costs for digging and filling pit, dozer costs for grade work, pit liner, and restoration charges.
- (4) Transportation - includes tractor-trailer rates for delivery of tubing/work string to the rig.
- (5) Miscellaneous - applies primarily to wells with casing not cemented to surface and includes wire line services, tool rental, bridge plug costs, hydraulic jack costs, etc.

All unit rates and estimated time charges were developed from plugging and abandonment estimates submitted to EPA from operators, job tickets and summaries from plugging and abandonment operations performed by operators to meet UIC requirements, and wells plugged and abandoned by EPA.

The total costs as presented on the attached schedule are based entirely on the premise that EPA will be required to obtain an independent contractor which will be charged with performing all phases of the plugging operation, including subcontracting for services as needed. These costs may from time to time be subject to revision as determined by EPA.

PLUGGING AND ABANDONMENT
COST SCHEDULE

<u>Well Depth*</u>	<u>Cement Top Behind Casing**</u>	
	<u>At Surface</u>	<u>Below Surface</u>
<500'	\$2300.00	\$3000.00
501' - 1000'	\$3000.00	\$3900.00
1001' - 1500'	\$3700.00	\$5000.00
1501' - 2000'	\$4800.00	\$6500.00
>2000'	\$5800.00	\$7400.00

* Refers to PBTB

** Primary protective string of casing

IRREVOCABLE STANDBY LETTER OF CREDIT

U.S. Environmental Protection Agency
Underground Injection Control
Financial Responsibility Requirement

To: Regional Administrator

U.S. Environmental Protection Agency, Region _____

(address of EPA Regional Office).

Dear Sir or Madam:

We hereby establish our Irrevocable Standby Letter of Credit No. _____
in your favor, at the request and the account of

(legal name of owner or operator)

(business address of owner or operator)

up to the aggregate amount of _____
(dollar amount in words)

U.S. dollars (\$ _____), available upon presentation of:

1. Your sight draft, bearing reference to this letter of credit No. _____, and
2. Your signed statement reading as follows: "I certify that the amount of the draft is payable pursuant to regulations issued under authority of the Safe Drinking Water Act."

This letter of credit is effective as of (date) _____ and shall expire on (date at least 1 year later) _____, but such expiration date shall be automatically extended for a period of (at least one year) _____ on (date) _____ and each successive expiration date, unless, at least 120 days before the current expiration date, we notify both you and (owner's or operator's name) _____ by certified mail that we have decided not to extend this letter of

PLEASE PREPARE FINANCIAL FORMS ON FINANCIAL INSTITUTION'S
LETTERHEAD AND PROVIDE CONTACT PERSON FOR FINANCIAL
INSTITUTION, ADDRESS, AND PHONE NUMBER.

credit beyond the current expiration date. In the event you are so notified, any unused portion of the credit shall be available upon presentation of your sight draft for 120 days after the date of receipt by both you and (owner's or operator's name) _____, as shown on the signed return receipts.

Whenever this letter of credit is drawn on under and in compliance with the terms of this credit, we shall duly honor such draft upon presentation to us, and we shall deposit the amount of the draft directly into the standby trust fund of (owner's or operator's name) _____ in accordance with your instructions.

(Signature) (Date)

(Name) (Title)

This credit is subject to:

() the most recent edition of the Uniform Customs and Practice for Documentary Credits, published by the International Chamber of Commerce,

OR

() the Uniform Commercial Code,

AND

() the operations of this bank/institution are regulated and examined by a State or Federal Agency.

S T A N D B Y T R U S T A G R E E M E N T

U.S. Environmental Protection Agency
Underground Injection Control
Financial Responsibility Requirement

TRUST AGREEMENT, the "Agreement," entered into as of _____
(date)

by and between _____,
(name of owner or operator)

a _____, the
(name of state) (corporation, partnership
association, or proprietorship)

"Grantor," and _____, () incorporated
(name of corporate trustee)

in the State of _____ or () a national bank, the

"Trustee."

WHEREAS, the United States Environmental Protection Agency, "EPA," an agency of the United States Government, has established certain regulations applicable to the Grantor, requiring that an owner or operator of an injection well shall provide assurance that funds will be available when needed for plugging and abandonment of the injection well, and

WHEREAS, the Grantor has elected to obtain () a surety bond () a letter of credit and establish a standby trust to provide all or part of such financial assurance for the facility(ies) identified herein, and

WHEREAS, the Grantor, acting through its duly authorized officers, has selected the Trustee to be the trustee under this Agreement, and the Trustee is willing to act as trustee,

NOW, THEREFORE, the Grantor and the Trustee agree as follows:

Section 1. Definitions. As used in this Agreement:

(a) The term "Grantor" means the owner or operator who enters into this Agreement and any successors or assigns of the Grantor.

(b) The term "Trustee" means the Trustee who enters into this Agreement and any successor Trustee.

(c) "Facility" or "activity" means any underground injection well or any other facility or activity that is subject to regulation under the Underground Injection Control Program.

Section 2. Identification of Facilities and Cost Estimates. This Agreement pertains to the facilities and cost estimates identified in Schedule A (attached). (Schedule A lists, for each facility, the EPA identification number, name, address, and the current plugging and abandonment cost estimate, or portions thereof, for which financial assurance is demonstrated.)

Section 3. Establishment of Fund. The Grantor and the Trustee hereby establish a trust fund, the "Fund," for the benefit of EPA. The Grantor and the Trustee intend that no third party have access to the Fund except as herein provided. The fund is established initially as consisting of the property, which is acceptable to the Trustee, described in Schedule B attached hereto. Such property and any other property subsequently transferred to the Trustee is referred to as the Fund, together with all earnings and profits thereon, less any payments or distributions made by the Trustee pursuant to this Agreement. The Fund shall be held by the Trustee, IN TRUST, as hereinafter provided. The Trustee shall not be responsible nor shall it undertake any responsibility for the amount or adequacy of, nor any duty to collect from the Grantor, any payments necessary to discharge any liabilities of the Grantor established by EPA.

Section 4. Payment for Plugging and Abandonment. The Trustee shall make payments from the Fund as the EPA Regional Administrator shall direct, in writing, to provide for the payment of the costs of plugging and abandonment of the injection wells covered by this Agreement. The Trustee shall reimburse the Grantor or other persons as specified by the EPA Regional Administrator from the Fund for plugging and abandonment expenditures in such amounts as the EPA Regional Administrator shall direct in writing. In addition, the Trustee shall refund to the Grantor such amounts as the EPA Regional Administrator specifies in writing. Upon refund, such funds shall no longer constitute part of the Fund as defined herein.

Section 5. Payments Comprising the Fund. Payments made to the Trustee for the Fund shall consist of cash or securities acceptable to the Trustee.

Section 6. Trustee Management. The Trustee shall invest and reinvest the principal and income of the Fund and keep the Fund invested as a single fund, without distinction between principal and income, in accordance with general investment policies and guidelines which the Grantor may communicate in writing to the Trustee from time to time, subject, however, to the provisions of this Section. In investing, reinvesting, exchanging, selling, and managing the Fund, the Trustee shall discharge his duties with respect to the trust fund solely in the interest of the beneficiary and with the care, skill, prudence, and diligence under the circumstances then prevailing, which persons of prudence, acting in a like capacity and familiar with such matters, would use in the conduct of an enterprise of a like character and with like aims, except that:

(a) Securities or other obligations of the Grantor, or any other owner or operator of the facilities, or any of their affiliates as defined in the Investment Company Act of 1940, as amended, 15 USC 80a-2.(a), shall not be acquired or held, unless they are securities or other obligations of the Federal or a State government;

(b) The Trustee is authorized to invest the Fund in time or demand deposits of the Trustee, to the extent insured by an agency of the Federal or State government; and

(c) The Trustee is authorized to hold cash awaiting investment or distribution uninvested for a reasonable time and without liability for the payment of interest thereon.

Section 7. Commingling and Investment. The Trustee is expressly authorized in its discretion:

(a) To transfer from time to time any or all of the assets of the Fund to any common, commingled, or collective trust fund created by the Trustee in which the Fund is eligible to participate, subject to all of the provisions thereof, to be commingled with the assets of other trusts participating therein; and

(b) To purchase shares in any investment company registered under the Investment Company Act of 1940, 15 U.S.C. 80a-1 et seq., including one which may be created, managed, underwritten, or to which investment advice is rendered or the shares of which are sold by the Trustee. The Trustee may vote such shares in its discretion.

Section 8. Express Powers of Trustees. Without in any way limiting the powers and discretions conferred upon the Trustee by the other provisions of this Agreement or by law, the Trustee is expressly authorized and empowered:

(a) To sell, exchange, convey, transfer, or otherwise dispose of any property held by it, by public or private sale. No person dealing with the Trustee shall be bound to see to the application of the purchase money or to inquire into the validity or expediency of any such sale or other disposition;

(b) To make, execute, acknowledge, and deliver any and all documents of transfer and conveyance and any and all other instruments that may be necessary or appropriate to carry out the powers herein granted;

(c) To register any securities held in the Fund in its own name or in the name of a nominee and to hold any security in bearer form or in book entry, or to combine certificates representing such securities with certificates of the same issue held by the Trustee in other fiduciary capacities, or to deposit or arrange for the deposit of any securities issued by the United States Government, or any agency or instrumentality thereof, with a Federal Reserve bank, but the books and records of the Trustee shall at all times show that all such securities are part of the Fund;

(d) To deposit any cash in the Fund in interest-bearing accounts maintained or savings certificates issued by the Trustee, in its separate corporate capacity, or in any other banking institution affiliated with the Trustee, to the extent insured by an agency of the Federal or State government; and

(e) To compromise or otherwise adjust all claims in favor of or against the Fund.

Section 9. Taxes and Expenses. All taxes of any kind that may be assessed or levied against or in respect of the Fund and all brokerage commissions incurred by the Fund shall be paid from the Fund. All other expenses incurred by the Trustee in connection with the administration of this Trust, including fees for legal services rendered to the Trustee, the compensation of the Trustee to the extent not paid directly by the Grantor, and all other proper charges and disbursements of the Trustee, shall be paid from the Fund.

Section 10. Annual Valuation. Commencing after initial funding of the trust, the Trustee shall annually, at least 30 days prior to the anniversary date of establishment of the Fund, furnish to the Grantor and to the appropriate EPA Regional Administrator a statement confirming the value of the Trust. Any securities in the Fund shall be valued at the market value as of no more than 60 days prior to the anniversary date of establishment of the Fund. The failure of the Grantor to object in writing to the Trustee within 90 days after the statement has been furnished to the Grantor and the EPA Regional Administrator shall constitute a conclusively binding assent by the Grantor, barring the Grantor from asserting any claim or liability against the Trustee with respect to matters disclosed in the statement.

Section 11. Advice of Counsel. The Trustee may from time to time consult with counsel, who may be counsel to the Grantor, with respect to any question arising as to the construction of this Agreement or any action to be taken hereunder. The Trustee shall be fully protected, to the extent permitted by law, in acting upon the advice of counsel.

Section 12. Trustee Compensation. The Trustee shall be entitled to reasonable compensation for its services as agreed upon in writing from time to time with the Grantor.

Section 13. Successor Trustee. The Trustee may resign or the Grantor may replace the Trustee, but such resignation or replacement shall not be effective until the Grantor has appointed a successor trustee and this successor accepts the appointment. The successor trustee shall have the same powers and duties as those conferred upon the Trustee hereunder. Upon the successor trustee's acceptance of the appointment, the Trustee shall assign, transfer, and pay over to the successor trustee the funds and properties then constituting the Fund. If for any reason the Grantor cannot or does not act in the event of the resignation of the Trustee, the Trustee, may apply to a court of competent jurisdiction for the appointment of a successor trustee or for instructions. The successor trustee shall specify the date on which it assumes administration of the trust in a writing sent to the Grantor, the EPA Regional Administrator, and the present Trustee by certified mail 10 days before such change becomes effective. Any expenses incurred by the Trustee as a result of any of the acts contemplated by this Section shall be paid as provided in Section 9.

Section 14. Instructions to the Trustee. All orders, requests, and instruction by the Grantor to the Trustee shall be in writing, signed by such persons as are designated in the attached Exhibit A, or such other designees as the Grantor may designate by amendment to Exhibit A. The Trustee shall be fully protected in acting without inquiry in accordance with the Grantor's orders, requests, and instructions. All orders, requests, and instructions by the EPA Regional Administrator to the Trustee shall be in writing, signed by the EPA Regional Administrators of the Regions in which the facilities are located, or their designees, and the Trustee shall act and shall be fully protected in acting in accordance with such orders, requests, and instructions. The Trustee shall have the right to assume, in the absence of written notice to the contrary, that no event constituting a change or a termination of the authority of any person to act on behalf of the Grantor or EPA hereunder has occurred. The Trustee shall have no duty to act in the absence of such orders, requests, and instructions from the Grantor and/or EPA, except as provided for herein.

Section 15. Amendment of Agreement. This Agreement may be amended by an instrument in writing executed by the Grantor, the Trustee, and the appropriate EPA Regional Administrator, or by the Trustee and the appropriate EPA Regional Administrator if the Grantor ceases to exist.

Section 16. Irrevocability and Termination. Subject to the right of the parties to amend this Agreement as provided in Section 15, this Trust shall be irrevocable and shall continue until terminated at the written agreement of the Grantor, the Trustee, and the EPA Regional Administrator, or by the Trustee and the EPA Regional Administrator if the Grantor ceases to exist. Upon termination of the Trust, all remaining trust property, less final trust administration expenses, shall be delivered to the Grantor.

Section 17. Immunity and Indemnification. The Trustee shall not incur personal liability of any nature in connection with any act or omission, made in good faith, in the administration of this Trust, or in carrying out any directions by the Grantor or the EPA Regional Administrator issued in accordance with this Agreement. The Trustee shall be indemnified and saved harmless by the Grantor or by the Trust Fund, or both, from and against any personal liability to which the Trustee may be subjected by reason of any act or conduct in its official capacity, including all expenses reasonably incurred in its defense in the event the Grantor fails to provide such defense.

Section 18. Choice of Law. This Agreement shall be administered, construed, and enforced according to the laws of the State of _____

Section 19. Interpretation. As used in this Agreement, words in the singular include the plural and words in the plural include the singular. The descriptive headings for each Section of this Agreement shall not affect the interpretation or the legal efficacy of this Agreement.

IN WITNESS WHEREOF, the parties below have caused this Agreement to be executed by their respective officers duly authorized and the corporate seals to be hereunto affixed and attested as of the date first above written.

By: _____
(Signature of Grantor)

(Title)

Attest: _____

(Title)

(SEAL)

By: _____
(Signature of Trustee)

(Title)

Attest: _____

(Title)

(SEAL)

() This bank/institution has the authority to act as a trustee and its trust activities are examined and regulated by a State or Federal agency.

CERTIFICATE OF ACKNOWLEDGMENT
FOR
TRUST FUND AGREEMENT

STATE OF _____

COUNTY OF _____

On this _____ day of _____, 19____, before me personally came _____ to me known, who,
(owner or operator)

being by me duly sworn, did depose and say that she/he resides at _____,
(address)

that she/he is _____ of _____,
(corporation), the corporation

described in and which executed the above instrument; that she/he knows the seal of said corporation; that the seal affixed to such instrument is such corporate seal; that it was so affixed by order of the Board of Directors of said corporation, and that she/he signed her/his name thereto by like order.

(Notary Public)

(Seal)

SCHEDULE A

Identification of Facilities and Cost Estimates

Schedule A is referenced in the trust agreement dated _____
by and between _____
the "Grantor," and _____ (name of owner or operator)
the "Trustee." _____ (name of trustee)

EPA identification number	_____
Name of facility	_____
Address of facility	_____
Current plugging and abandonment cost estimate	_____
Date of estimate	_____
EPA identification number	_____
Name of facility	_____
Address of facility	_____
Current plugging and abandonment cost estimate	_____
Date of estimate	_____

SCHEDULE B

IDENTIFICATION OF FUND

Schedule B is referenced in the Standby Trust Agreement date _____

by and between _____
(name of owner or operator)

the "Grantor" and _____
(name of trustee)

the "Trustee."

The Fund consists of: (check one and provide identification number)

Irrevocable Letter of Credit No. _____

Surety Performance Bond No. _____

Other (describe)

T R U S T A G R E E M E N T

U.S. Environmental Protection Agency
Underground Injection Control
Financial Responsibility Requirement

TRUST AGREEMENT, the "Agreement," entered into as of _____ (date)
by and between _____, a
(name of owner or operator)

_____, the
(name of state) (corporation, partnership
association, or proprietorship)

"Grantor," and _____,
(name of corporate trustee) (incorporated in the
State of _____)

the "Trustee." or a national bank)

WHEREAS, the United States Environmental Protection Agency, "EPA," an agency of the United States Government, has established certain regulations applicable to the Grantor, requiring that an owner or operator of an injection well shall provide assurance that funds will be available when needed for plugging and abandonment of the injection well,

WHEREAS, the Grantor has elected to establish a trust to provide all or part of such financial assurance for the facility(ies) identified herein, and

WHEREAS, the Grantor, acting through its duly authorized officers, has selected the Trustee to be the trustee under this Agreement, and the Trustee is willing to act as trustee,

NOW, THEREFORE, the Grantor and the Trustee agree as follows:

Section 1. Definitions. As used in this Agreement:

(a) The term "Grantor" means the owner or operator who enters into this Agreement and any successors or assigns of the Grantor.

(b) The term "Trustee" means the Trustee who enters into this Agreement and any successor Trustee.

(c) "Facility" or "activity" means any underground injection well or any facility or activity that is subject to regulation under the Underground Injection Control Program.

Section 2. Identification of Facilities and Cost Estimates. This Agreement pertains to the facilities and cost estimates identified in Schedule A (attached). (Schedule A lists, for each facility, the EPA identification number, name, address, and the current plugging and abandonment cost estimate, or portions thereof, for which financial assurance is demonstrated.)

Section 3. Establishment of Fund. The Grantor and the Trustee hereby establish a trust fund, the "Fund," for the benefit of EPA. The Grantor and the Trustee intend that no third party have access to the Fund except as herein provided. The fund is established initially as consisting of the property, which is acceptable to the Trustee, described in Schedule B attached hereto. Such property and any other property subsequently transferred to the Trustee is referred to as the Fund, together with all earnings and profits thereon, less any payments or distributions made by the Trustee pursuant to this Agreement. The Fund shall be held by the Trustee, IN TRUST, as hereinafter provided. The Trustee shall not be responsible nor shall it undertake any responsibility for the amount or adequacy of, nor any duty to collect from the Grantor, any payments necessary to discharge any liabilities of the Grantor established by EPA.

Section 4. Payment for Plugging and Abandonment. The Trustee shall make payments from the Fund as the EPA Regional Administrator shall direct, in writing, to provide for the payment of the costs of plugging and abandonment of the injection wells covered by this Agreement. The Trustee shall reimburse the Grantor or other persons as specified by the EPA Regional Administrator from the Fund for plugging and abandonment expenditures in such amounts as the EPA Regional Administrator shall direct in writing. In addition, the Trustee shall refund to the Grantor such amounts as the EPA Regional Administrator specifies in writing. Upon refund, such funds shall no longer constitute part of the Fund as defined herein.

Section 5. Payments Comprising the Fund. Payments made to the Trustee for the Fund shall consist of cash or securities acceptable to the Trustee.

Section 6. Trustee Management. The Trustee shall invest and reinvest the principal and income of the Fund and keep the Fund invested as a single fund, without distinction between principal and income, in accordance with general investment policies and guidelines which the Grantor may communicate in writing to the Trustee from time to time, subject, however, to the provisions of this Section. In investing, reinvesting, exchanging, selling, and managing the Fund, the Trustee shall discharge his duties with respect to the trust fund solely in the interest of the beneficiary and with the care, skill, prudence, and diligence under the circumstances then prevailing, which persons of prudence, acting in

a like capacity and familiar with such matters, would use in the conduct of an enterprise of a like character and with like aims, except that:

(i) Securities or other obligations of the Grantor, or any other owner or operator of the facilities, or any of their affiliates as defined in the Investment Company Act of 1940, as amended, 15 USC 80a-2.(a), shall not be acquired or held, unless they are securities or other obligations of the Federal or a State government;

(ii) The Trustee is authorized to invest the Fund in time or demand deposits of the Trustee, to the extent insured by an agency of the Federal or State government; and

(iii) The Trustee is authorized to hold cash awaiting investment or distribution uninvested for a reasonable time and without liability for the payment of interest thereon.

Section 7. Commingling and Investment. The Trustee is expressly authorized in its discretion:

(a) To transfer from time to time any or all of the assets of the Fund to any common, commingled, or collective trust fund created by the Trustee in which the Fund is eligible to participate, subject to all of the provisions thereof, to be commingled with the assets of other trusts participating therein; and

(b) To purchase shares in any investment company registered under the Investment Company Act of 1940, 15 U.S.C. 80a-1 et seq., including one which may be created, managed, underwritten, or to which investment advice is rendered or the shares of which are sold by the Trustee. The Trustee may vote such shares in its discretion.

Section 8. Express Powers of Trustees. Without in any way limiting the powers and discretions conferred upon the Trustee by the other provisions of this Agreement or by law, the Trustee is expressly authorized and empowered:

(a) To sell, exchange, convey, transfer, or otherwise dispose of any property held by it, by public or private sale. No person dealing with the Trustee shall be bound to see to the application of the purchase money or to inquire into the validity or expediency of any such sale or other disposition;

(b) To make, execute, acknowledge, and deliver any and all documents of transfer and conveyance and any all other instruments that may be necessary or appropriate to carry out the powers herein granted;

(c) To register any securities held in the Fund in its own name or in the name of a nominee and to hold any security in bearer

form or in book entry, or to combine certificates representing such securities with certificates of the same issue held by the Trustee in other fiduciary capacities, or to deposit or arrange for the deposit of any securities issued by the United States Government, or any agency or instrumentality thereof, with a Federal Reserve bank, but the books and records of the Trustee shall at all times show that all such securities are part of the Fund;

(d) To deposit any cash in the Fund in interest-bearing accounts maintained or savings certificates issued by the Trustee, in its separate corporate capacity, or in any other banking institution affiliated with the Trustee, to the extent insured by an agency of the Federal or State government; and

(e) To compromise or otherwise adjust all claims in favor of or against the Fund.

Section 9. Taxes and Expenses. All taxes of any kind that may be assessed or levied against or in respect of the Fund and all brokerage commissions incurred by the Fund shall be paid from the Fund. All other expenses incurred by the Trustee in connection with the administration of this Trust, including fees for legal services rendered to the Trustee, the compensation of the Trustee to the extent not paid directly by the Grantor, and all other proper charges and disbursements of the Trustee, shall be paid from the Fund.

Section 10. Annual Valuation. The Trustee shall annually, at least 30 days prior to the anniversary date of establishment of the Fund, furnish to the Grantor and to the appropriate EPA Regional Administrator a statement confirming the value of the Trust. Any securities in the Fund shall be valued at the market value as of no more than 60 days prior to the anniversary date of establishment of the Fund. The failure of the Grantor to object in writing to the Trustee within 90 days after the statement has been furnished to the Grantor and the EPA Regional Administrator shall constitute a conclusively binding assent by the Grantor, barring the Grantor from asserting any claim or liability against the Trustee with respect to matters disclosed in the statement.

Section 11. Advice of Counsel. The Trustee may from time to time consult with counsel, who may be counsel to the Grantor, with respect to any questions arising as to the construction of this Agreement or any action to be taken hereunder. The Trustee shall be fully protected, to the extent permitted by law, in acting upon the advice of counsel.

Section 12. Trustee Compensation. The Trustee shall be entitled to reasonable compensation for its services as agreed upon in writing from time to time with the Grantor.

Section 13. Successor Trustee. The Trustee may resign or the Grantor may replace the Trustee, but such resignation or replacement shall not be effective until the Grantor has appointed a successor trustee and this successor accepts the appointment. The successor trustee shall have the same powers and duties as those conferred upon the Trustee hereunder. Upon the successor trustee's acceptance of the appointment, the Trustee shall assign, transfer, and pay over to the successor trustee the funds and properties then constituting the Fund. If for any reason the Grantor cannot or does not act in the event of the resignation of the Trustee, the Trustee may apply to a court of competent jurisdiction for the appointment of a successor trustee or for instructions. The successor trustee shall specify the date on which it assumes administration of the trust in a writing sent to the Grantor, the EPA Regional Administrator, and the present Trustee by certified mail 10 days before such change becomes effective. Any expenses incurred by the Trustee as a result of any of the acts contemplated by this Section shall be paid as provided in Section 9.

Section 14. Instructions to the Trustee. All orders, requests, and instruction by the Grantor to the Trustee shall be in writing, signed by such persons as are designated in the attached Exhibit A, or such other designees as the Grantor may designate by amendment to Exhibit A. The Trustee shall be fully protected in acting without inquiry in accordance with the Grantor's orders, requests, and instructions. All orders, requests, and instructions by the EPA Regional Administrator to the Trustee shall be in writing, signed by the EPA Regional Administrators of the Regions in which the facilities are located, or their designees, and the Trustee shall act and shall be fully protected in acting in accordance with such orders, requests, and instructions. The Trustee shall have the right to assume, in the absence of written notice to the contrary, that no event constituting a change or a termination of the authority of any person to act on behalf of the Grantor or EPA hereunder has occurred. The Trustee shall have no duty to act in the absence of such orders, requests, and instructions from the Grantor and/or EPA, except as provided for herein.

Section 15. Notice of Nonpayment. The Trustee shall notify the Grantor and the appropriate EPA Regional Administrator, by certified mail within 10 days following the expiration of the 30-day period after the anniversary of the establishment of the Trust, if no payment is received from the Grantor during that period. After the pay-in period is completed, the Trustee shall not be required to send a notice of nonpayment.

Section 16. Amendment of Agreement. This Agreement may be amended by an instrument in writing executed by the Grantor, the Trustee, and the appropriate EPA Regional Administrator, or by the Trustee and the appropriate EPA Regional Administrator if the Grantor ceases to exist.

Section 17. Irrevocability and Termination. Subject to the right of the parties to amend this Agreement as provided in Section 16, this Trust shall be irrevocable and shall continue until terminated at the written agreement of the Grantor, the Trustee, and the EPA Regional Administrator, or by the Trustee and the EPA Regional Administrator if the Grantor ceases to exist. Upon termination of the Trust, all remaining trust property, less final trust administration expenses, shall be delivered to the Grantor.

Section 18. Immunity and Indemnification. The Trustee shall not incur personal liability of any nature in connection with any act or omission, made in good faith, in the administration of this Trust, or in carrying out any directions by the Grantor or the EPA Regional Administrator issued in accordance with this Agreement. The Trustee shall be indemnified and saved harmless by the Grantor or by the Trust Fund, or both, from and against any personal liability to which the Trustee may be subjected by reason of any act or conduct in its official capacity, including all expenses reasonably incurred in its defense in the event the Grantor fails to provide such defense.

Section 19. Choice of Law. This Agreement shall be administered, construed, and enforced according to the laws of the State of _____.
(name of state)

Section 20. Interpretation. As used in this Agreement, words in the singular include the plural and words in the plural include the singular. The descriptive headings for each Section of this Agreement shall not affect the interpretation or the legal efficacy of this Agreement.

CERTIFICATE OF ACKNOWLEDGMENT
FOR
TRUST FUND AGREEMENT

STATE OF _____

COUNTY OF _____

On this _____ day of _____, 19____, before me personally came _____ to me known, who,
(owner or operator)

being by me duly sworn, did depose and say that she/he resides at _____,
(address)

that she/he is _____ of _____
(title)

_____, the corporation
(corporation)

described in and which executed the above instrument; that she/he knows the seal of said corporation; that the seal affixed to such instrument in such corporate seal; that it was so affixed by order of the Board of Directors of said corporation, and that she/he signed her/his name thereto by like order.

(Notary Public)

(Seal)

IN WITNESS WHEREOF, the parties below have caused this Agreement to be executed by their respective officers duly authorized and the corporate seals to be hereunto affixed and attested as of the date first above written.

By: _____
(Signature of Grantor)

(Title)

Attest: _____

(Title)

(SEAL)

By: _____
(Signature of Trustee)

(Title)

Attest: _____

(Title)

(SEAL)

() This bank/institution has the authority to act as a trustee and its trust activities are examined and regulated by a State or Federal agency.

SCHEDULE A

Identification of Facilities and Cost Estimates

Schedule A is referenced in the trust agreement dated _____
by and between _____,
(name of owner or operator)
the "Grantor," and _____
(name of trustee)
the "Trustee."

EPA identification number _____
Name of facility _____
Address of facility _____

Current plugging and
abandonment cost estimate _____
Date of estimate _____

EPA identification number _____
Name of facility _____
Address of facility _____

Current plugging and
abandonment cost estimate _____
Date of estimate _____

SCHEDULE B

IDENTIFICATION OF FUND

Schedule B is referenced in the Trust Agreement dated _____

by and between _____

the "Grantor" and _____
(name of owner or operator)

the "Trustee." _____
(name of trustee)

The fund consists of: (check one and provide identification number)

() Irrevocable Letter of Credit No. _____

() Surety Performance Bond No. _____

() Other (describe) _____

SURETY PERFORMANCE BOND

U.S. Environmental Protection Agency
Underground Injection Control
Financial Responsibility Requirement

BOND COVERS THE PLUGGING OF INJECTION WELLS

Date bond executed: _____

Effective date: _____

Principal: _____
(Legal name of owner or operator)

(Business address of owner or operator)

Type of organization: _____
(Individual, joint venture,
partnership, or corporation)

State of incorporation: _____

Surety(is): _____
(Name)

(Business Address)

EPA identification number, name, address, and plugging and abandonment amount(s) for each injection well guaranteed by this bond. (Indicate plugging and abandonment amounts for each well. Attach separate list if necessary.)

<u>Injection Well Information</u>	<u>Plugging & Abandonment Amount</u>
_____	_____
_____	_____
_____	_____
_____	_____
_____	_____

Total penal sum of bond: \$ _____

Surety's bond number: _____

KNOW ALL PERSONS. BY THESE PRESENTS, That we, the Principal and Surety(ies) hereto are firmly bound to the U.S. Environmental Protection Agency (hereinafter called EPA), in the above penal sum for the payment of which we bind ourselves, our heirs, executors, administrators, successors, and assigns jointly and severally; provided that, were the Surety(ies) are corporations acting as co-sureties, we, the Sureties, bind ourselves in such sum "jointly and severally" only for the purpose of allowing a joint action or actions against any or all of us, and for all other purposes each Surety binds itself, jointly and severally with the Principal, for the payment of such sum only as is set forth opposite the name of such surety, but if no limit of liability is indicated, the limit of liability shall be the full amount of the penal sum.

WHEREAS said Principal is required, under the Underground Injection Control Regulations, as amended, to have a permit or comply with provisions to operate under rule for each injection well identified above, and

WHEREAS said Principal is required to provide financial assurance for plugging and abandonment as a condition of the permit or approval to operate under rule, and

WHEREAS said Principal shall establish a standby trust fund as is required when a surety bond is used to provide such financial assurance;

NOW, THEREFORE, the conditions of this obligation are such that if the Principal shall faithfully perform plugging and abandonment, whenever required to do so, of each injection well for which this bond guarantees plugging and abandonment, in accordance with the plugging and abandonment plan and other requirements of the permit or provisions for operating under rule and other requirements of the permit or provisions for operating under rule as may be amended, pursuant to all applicable laws, statutes, rules and regulations, as such laws, statutes, rules, and regulations may be amended,

Or, if the Principal shall provide alternate financial assurance as specified in Subpart F of 40 CFR 144, and obtain the EPA Regional Administrator's written approval of such assurance, within 90 days after the date of notice of cancellation is received by both the Principal and the EPA Regional Administrator(s) from the Surety(ies), then this obligation shall be null and void. Otherwise it is to remain in full force and effect.

The Surety(ies) shall become liable on this bond obligation only when the Principal has failed to fulfill the conditions described above.

Upon notification by an EPA Regional Administrator that the Principal has been found in violation of the plugging and abandonment requirements of 40 CFR 144, for an injection well which this bond guarantees performances of plugging and abandonment, the Surety(ies) shall either perform plugging and abandonment in accordance with the plugging and abandonment plan and other permit requirements or provisions for operating under rule and other

requirements or place the amount for plugging and abandonment into standby trust fund as directed by the EPA Regional Administrator.

Upon notification by an EPA Regional Administrator that the Principal has failed to provide alternate financial assurance as specified in Subpart F of 40 CFR 144, and obtain written approval of such assurance from the EPA Regional Administrator(s) during the 90 days following receipt by both the Principal and the EPA Regional Administrator(s) of a notice of cancellation of the bond, the Surety(ies) shall place funds in the amount guaranteed for the injection well(s) into the standby trust fund as directed by the EPA Regional Administrator.

The Surety(ies) hereby waive(s) notification of amendments to plugging and abandonment plans, permits, applicable laws, statutes, rules, and regulations and agrees that no such amendment shall in any way alleviate its (their) obligation on this bond.

The liability of the Surety(is) shall not be discharged by any payment or succession of payments hereunder, unless and until such payment or payments shall amount in the aggregate to the penal sum of the bond, but in no event shall the obligation of the Surety(ies) here under exceed the amount of said penal sum.

The Surety(ies) may cancel the bond by sending notice by certified mail to the owner or operator and to the EPA Regional Administrator(s) for the Region(s) in which the injection well(s) is (are) located, provided, however, that cancellation shall not occur during the 120 days beginning on the date of receipt of the notice of cancellation by both the Principal and the EPA Regional Administrator(s), as evidenced by the return receipts.

The Principal may terminate this bond by sending written notice to the Surety(ies); provided, however, that no such notice shall become effective until the Surety(ies) receive(s) written authorization for termination of the bond by the EPA Regional Administrator(s) of the EPA Region(s) in which the bonded injection well(s) is (are) located.

(The following paragraph is an optional rider that may be included but is not required.)

Principal and Surety(ies) hereby agree to adjust the penal sum of the bond yearly so that it guarantees a new plugging and abandonment amount, provided that the penal sum does not increase by more than 20% in any one year, and no decrease in the penal sum takes place without the written permission of the EPA Regional Administrator(s).

In WITNESS WHEREOF, The Principal and Surety(ies) have executed this Performance Bond and have affixed their seals on the date set forth above.

The persons whose signature appear below hereby certify that they are authorized to execute this surety bond on behalf of the Principal and Surety(ies) and that the wording on this surety bond is identical to the wording specified in 40 CFR 144.70(c) as such regulation was constituted on the date this bond was executed.

PRINCIPAL:

CORPORATE SURETY(IES):

(Name)

(Name)

(Address)

(Address)

(Signature(s))

(Signature(s))

(Name(s))

(Name(s))

(Title(s))

(Title(s))

Corporate Seal

Corporate Seal

State of Incorporation

State of Incorporation

\$ _____
Bond Premium

\$ _____
Liability Limit

(For every co-surety, provide signature(s), corporate seal, and other information in the same manner as for Surety above.)

C H I E F F I N A N C I A L O F F I C E R ' S L E T T E R

U.S. Environmental Protection Agency
Underground Injection Control
Class II Injection Well Operators

This letter contains information submitted as evidence of financial responsibility for the Environmental Protection Agency's underground injection control requirements.

Submitted to: Regional Administrator
Environmental Protection Agency, Region _____

(Address of EPA Regional Office)

Submitted for: _____
(Legal name of owner or operator company)

(Business address of owner or operator)

Type of organization: _____
(Individual, joint venture, partnership,
or corporation)

Date of incorporation: _____

State of incorporation: _____

Submitted by: _____
(Name of Chief Financial Officer)

(Name of Firm)

(Business Address)

I hereby certify that the financial information contained on the following pages is correct and derived from this firm's independently audited, year-end financial statements for the latest completed fiscal year ended _____.

(Signature of Financial Officer)

(Date)

I. (Firm name) _____
is the owner or operator of Class II injection wells in the
following states within EPA Region _____:

State names: _____

II. This firm guarantees the plugging and abandonment of injection
wells owned or operated by the following subsidiaries:

Subsidiary name:	Subsidiary address:
_____	_____
_____	_____
_____	_____
_____	_____

III. This firm is () required () not required to file a Form 10-K
with the Securities and Exchange Commission (SEC) for the
latest fiscal year.

IV. The fiscal year of this firm ends on (month/day) _____
_____. The financial information contained in this letter is
derived from this firm's independently audited, year-end
financial statements for the latest completed fiscal year
ended (date) _____.

The name and address of the accounting firm auditing these
financial statements:

(Name of auditing firm)

(Address of auditing firm)

V. The dollar amounts below are stated in () actual () thousands of dollars.

Financial Information

Balance Sheet Information:

- 1. Current Assets _____
- 2. Total Assets _____
- 3. Current Liabilities _____
- 4. Total Liabilities _____
- 5. Net Worth or Stockholder's Equity _____

Income Statement Information

- 6. Depreciation, Depletion, and Amortization _____
- 7. Net Income _____

Calculations

- 8. Total Liabilities less Current Liabilities
(Item 4 - Item 3) _____
- 9. Depreciation, Depletion, and Amortization plus
Net Income
(Item 6 + Item 7) _____
- 10. Current Assets less Current Liabilities
(Item 1 - Item 3;
indicate negative numbers with parentheses) _____
- 11. Current Liabilities divided by Net Worth
(Item 3 + Item 5;
round to two decimal places) _____
- 12. Total Liabilities less Current Liabilities, all
divided by Net Worth
(Item 8 + Item 5;
round to two decimal places) _____
- 13. Depreciation, Depletion, and Amortization plus
Net income, all divided by Total Liabilities
(Item 9 + Item 4;
round to three decimal places) _____
- 14. Current Assets less Current Liabilities, all
divided by Total Assets
(Item 10 + Item 2;
round to two decimal places, indicate negative
numbers with parentheses) _____

VI. Based on the information in Part V, the company meets or does not meet the financial ratio requirements, as indicated.

	<u>Yes</u>	<u>No</u>
1. Current Liabilities + Net Worth less than 1.0 (Item V-11 less than 1.0)	_____	_____
2. Long-Term Liabilities + Net Worth less than 2.0 (Item V-12 less than 2.0)	_____	_____
3. Net Income greater than zero. (Item V-7 greater than 0)	_____	_____
4. Net Income + depreciation, depletion and amortization total + total liabilities greater than 0.10 (Item V-13 is greater than 0.10)	_____	_____
5. Working Capital + Total Assets greater than -0.10 (Item 14 greater than -0.10)	_____	_____

VII. This firm () has () has not received a rating by either Standard and Poor's or Moody's.

The current bond rating of most recent issuance of this firm _____

The name of the rating service _____

The date of issuance of bond _____

The name of maturity of bond _____

	<u>Yes</u>	<u>No</u>	<u>Not Available</u>
VIII. This firm's bond rating by standard and Poor's is AAA, AA, A or BBB	_____	_____	_____
This firm's bond rating by Moody's is Aaa, A or Baa	_____	_____	_____

A U D I T O R ' S V E R I F I C A T I O N O F
C H I E F F I N A N C I A L O F F I C E R ' S L E T T E R

This letter is verification of the financial information and calculations in the chief financial officer's letter submitted to the Environmental Protection Agency.

Submitted to: The Regional Administrator
Environmental Protection Agency, Region _____

(Address of EPA Regional Office)

We have examined the financial officer's letter submitted by (legal name of owner or operating company) _____
to the Environmental Protection Agency, dated _____.

The financial information corresponds to the data contained in the firm's audited financial statements for the fiscal year ending _____. As a result of our examination, we verify that the financial information and calculations contained in this letter are correct and accurate.

(Name of accounting firm)

(Business address)

(Signature)

(Date)

(Name)

(Title)



COMPLETION REPORT FOR BRINE DISPOSAL, HYDROCARBON STORAGE, OR ENHANCED RECOVERY WELL

Form Approved
OMB No. 2040-0042
Approval Expires 6-30-98

NAME AND ADDRESS OF EXISTING PERMITTEE

NAME AND ADDRESS OF SURFACE OWNER

LOCATE WELL AND OUTLINE UNIT ON
SECTION PLAT — 640 ACRES

STATE

COUNTY

PERMIT NUMBER

SURFACE LOCATION DESCRIPTION

___ 1/4 of ___ 1/4 of ___ 1/4 of ___ 1/4 of Section ___ Township ___ Range ___

LOCATE WELL IN TWO DIRECTIONS FROM NEAREST LINES OF QUARTER SECTION AND DRILLING UNIT

Surface
Location ___ ft. from (N/S) ___ Line of quarter section
and ___ ft. from (E/W) ___ Line of quarter section

WELL ACTIVITY

TYPE OF PERMIT

- Brine Disposal
- Enhanced Recovery
- Hydrocarbon Storage
- Individual
- Area

Estimated Fracture Pressure
- of Injection Zone

Number of Wells ___

Anticipated Daily Injection Volume (Bbls)

Injection Interval

Average

Maximum

Feet

to Feet

Anticipated Daily Injection Pressure (PSI)

Depth to Bottom of Lowermost Freshwater Formation
(Feet)

Average

Maximum

Type of Injection Fluid (Check the appropriate block(s))

- Salt Water
- Brackish Water
- Fresh Water
- Liquid Hydrocarbon
- Other

Lease Name

Well Number

Name of Injection Zone

Date Drilling Began

Date Well Completed

Permeability of Injection Zone

Date Drilling Completed

Porosity of Injection Zone

CASING AND TUBING

CEMENT

HOLE

OD Size

Wt/Ft — Grade — New or Used

Depth

Sacks

Class

Depth

Bit Diameter

INJECTION ZONE STIMULATION

WIRE LINE LOGS, LIST EACH TYPE

Interval Treated

Materials and Amount Used

Log Types

Logged Intervals

Complete Attachments A — E listed on the reverse.

CERTIFICATION

I certify under the penalty of law that I have personally examined and am familiar with the information submitted in this document and all attachments and that, based on my inquiry of those individuals immediately responsible for obtaining the information, I believe that the information is true, accurate, and complete. I am aware that there are significant penalties for submitting false information, including the possibility of fine and imprisonment. (Ref. 40 CFR 144.32).

NAME AND OFFICIAL TITLE (Please type or print)

DATE SIGNED

COMMONWEALTH OF KENTUCKY
 DEPARTMENT OF MINES AND MINERALS
 DIVISION OF OIL AND GAS
 PO BOX 14090
 LEXINGTON KY 40512-4090
 PHONE 606 246-2026

CERTIFICATE OF COMPLETION FOR AN INJECTION WELL

- 1) Permit No. _____ (A copy of well location plat must be attached)
- 2) Operator (name and address) _____
- 3) Lease Name _____ Well No. _____
- 4) Carter Coordinate _____ ftl/fsl _____ fwl/fel sec _____ letter _____ no. _____
- 5) County _____ Elevation _____ Total Depth _____
- 6) The casing program for the above identified well is as follows:

Casing Size	New or Used	No. Sacks Cement	Cement Column - Top to Bottom
_____	_____	_____	_____
_____	_____	_____	_____
_____	_____	_____	_____
_____	_____	_____	_____
- 7) Injection shall be accomplished through tubing and packer as described below.

Size of Tubing	Type of Packer	Packer Depth
_____	_____	_____
_____	_____	_____
_____	_____	_____
- 8) Was cement bond log run? YES / NO If yes, attach one copy.
- 9) Maximum anticipated injection pressure at well head _____ psi.
- 10) Maximum anticipated injection volume _____ (bbbls) (cu.ft.) per day.
- 11) The injection zone is known as the (geological name) _____, and this formation occurs in this well from _____ to _____.
- 12) a. The _____ size casing has been cemented to a depth of _____ and the perforated interval is from _____ to _____ with _____ number of perforations.
 b. The injection interval is through an open hole and porous strata below the injection interval has not been drilled or is plugged back with a column of cement from _____ to _____.
- 13) Describe in detail the monitoring method for the annulus between the injection tubing and the next string of casing. Identify the type of instrument to be used and the time interval between observations by a responsible party. Records of monitoring must be kept on file by the operator and available to the Division of Oil and Gas Conservation upon request. (Use additional pages if needed.)
- 14) I, the operator of the above identified well, certify that the above information is accurate and correct and I further certify that I have run the following mechanical integrity test(s) of the installation to insure there are no leaks in the system. (Describe each test fully) (Use additional pages if needed) (Test Pressures must exceed the maximum anticipated injection pressure listed on line 9 by at least 100 psi)

Certified by _____ (operator's signature only)
 date _____ name of signee _____



UNITED STATES ENVIRONMENTAL PROTECTION AGENCY
WASHINGTON, DC 20460

PLUGGING AND ABANDONMENT PLAN

NAME AND ADDRESS OF FACILITY

NAME AND ADDRESS OF OWNER/OPERATOR

LOCATE WELL AND OUTLINE UNIT ON SECTION PLAT — 640 ACRES

STATE

COUNTY

PERMIT NUMBER

SURFACE LOCATION DESCRIPTION

___ 1/4 of ___ 1/4 of ___ 1/4 of ___ 1/4 of Section ___ Township ___ Range ___

LOCATE WELL IN TWO DIRECTIONS FROM NEAREST LINES OF QUARTER SECTION AND DRILLING UNIT

Surface Location ___ ft. from (N/S) ___ Line of quarter section
and ___ ft. from (E/W) ___ Line of quarter section

TYPE OF AUTHORIZATION

- Individual Permit
- Area Permit
- Rule

Number of Wells ___

Lease Name

WELL ACTIVITY

- CLASS I
- CLASS II
 - Brine Disposal
 - Enhanced Recovery
 - Hydrocarbon Storage
- CLASS III

Well Number

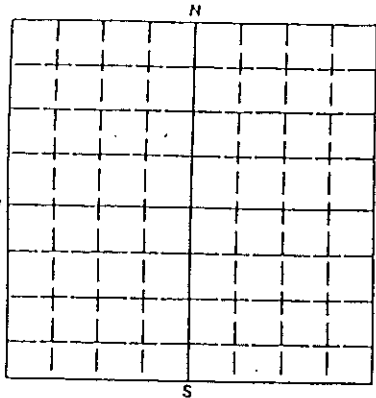

CASING AND TUBING RECORD AFTER PLUGGING

METHOD OF EMPLACEMENT OF CEMENT PLUGS

SIZE	WT(LB/FT)	TO BE PUT IN WELL (FT)	TO BE LEFT IN WELL (FT)	HOLE SIZE

- The Balance Method
- The Dump Bailer Method
- The Two-Plug Method
- Other

CEMENTING TO PLUG AND ABANDON DATA:

	PLUG #1	PLUG #2	PLUG #3	PLUG #4	PLUG #5	PLUG #6	PLUG #7
Size of Hole or Pipe In which Plug Will Be Placed (inches)							
Depth to Bottom of Tubing or Drill Pipe (ft.)							
Amount of Cement To Be Used (each plug)							
Surge Volume To Be Pumped (cu. ft.)							
Estimated Top of Plug (ft.)							
Measured Top of Plug (if tagged ft.)							
Surge Wt. (Lb./Gal.)							
Type Cement or Other Material (Class III)							

LIST ALL OPEN HOLE AND/OR PERFORATED INTERVALS AND INTERVALS WHERE CASING WILL BE VARIED (If any)

From	To	From	To

Estimated Cost to Plug Wells

CERTIFICATION

I certify under the penalty of law that I have personally examined and am familiar with the information submitted in this document and all attachments and that based on my inquiry of those individuals immediately responsible for obtaining the information, I believe that the information is true, accurate, and complete. I am aware that there are significant penalties for submitting false information, including the possibility of fine and imprisonment. (Ref. 40 CFR 144.32)

NAME AND OFFICIAL TITLE (Please type or print)

SIGNATURE

DATE SIGNED



United States Environmental Protection Agency
 Washington, DC 20460
Application To Transfer Permit

Name and Address of Existing Permittee	Name and Address of Surface Owner
----------------------------------------	-----------------------------------

Locate Well and Outline Unit on Section Plat- 640 Acres 	State	County	Permit Number
	Surface Location Description ___ 1/4 of ___ 1/4 of ___ 1/4 of ___ 1/4 of Section ___ Township ___ Range ___		
	Locate well in two directions from nearest lines of quarter section and drilling unit		
	Surface Location ___ ft. from (N/S) ___ Line of quarter section and ___ ft. from (E/W) ___ Line of quarter section.		
Well Activity <input type="checkbox"/> Class I <input type="checkbox"/> Class II <input type="checkbox"/> Brine Disposal <input type="checkbox"/> Enhanced Recovery <input type="checkbox"/> Hydrocarbon Storage <input type="checkbox"/> Class III <input type="checkbox"/> Other		Well Status <input type="checkbox"/> Operating <input type="checkbox"/> Modification/Conversion <input type="checkbox"/> Proposed	Type of Permit <input type="checkbox"/> Individual <input type="checkbox"/> Area Number of Wells ___
Lease Number		Well Number	

Name(s) and Address(es) of New Owner(s)	Name and Address of New Operator
-----------------------------------------	----------------------------------

Attach to this application a written agreement between the existing and new permittee containing a specific date for transfer of permit responsibility, coverage, and liability between them.

The new permittee must show evidence of financial responsibility by the submission of a surety bond, or other adequate assurance, such as financial statements or other materials acceptable to the Director.

Certification

I certify under the penalty of law that I have personally examined and am familiar with the information submitted in this document and all attachments and that, based on my inquiry of those individuals immediately responsible for obtaining the information, I believe that the information is true, accurate, and complete. I am aware that there are significant penalties for submitting false information, including the possibility of fine and imprisonment. (Ref. 40 CFR 144.32)

Name and Official Title (Please type or print)	Signature	Date Signed
------------------------------------------------	-----------	-------------



WELL REWORK RECORD

NAME AND ADDRESS OF PERMITTEE

NAME AND ADDRESS OF CONTRACTOR

LOCATE WELL AND OUTLINE UNIT ON SECTION PLAT -- 640 ACRES

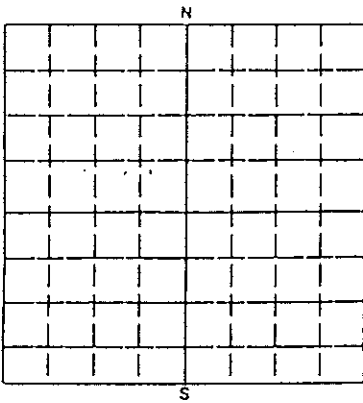

STATE

COUNTY

PERMIT NUMBER

SURFACE LOCATION DESCRIPTION

1/4 of 1/4 of 1/4 of 1/4 of Section Township Range

LOCATE WELL IN TWO DIRECTIONS FROM NEAREST LINES OF QUARTER SECTION AND DRILLING UNIT

Surface Location ft. from (N/S) Line of quarter section and ft. from (E/W) Line of quarter section

WELL ACTIVITY

- Brine Disposal
- Enhanced Recovery
- Hydrocarbon Storage

Lease Name

Total Depth Before Rework

Total Depth After Rework

Date Rework Commenced

Date Rework Completed

TYPE OF PERMIT

- Individual
 - Area
- Number of Wells

Well Number

WELL CASING RECORD -- BEFORE REWORK

Casing		Cement		Perforations		Acid or Fracture Treatment Record
Size	Depth	Sacks	Type	From	To	

WELL CASING RECORD -- AFTER REWORK (Indicate Additions and Changes Only)

Casing		Cement		Perforations		Acid or Fracture Treatment Record
Size	Depth	Sacks	Type	From	To	

DESCRIBE REWORK OPERATIONS IN DETAIL USE ADDITIONAL SHEETS IF NECESSARY

WIRE LINE LOGS, LIST EACH TYPE

Log Types

Logged Intervals

CERTIFICATION

I certify under the penalty of law that I have personally examined and am familiar with the information submitted in this document and all attachments and that, based on my inquiry of those individuals immediately responsible for obtaining the information, I believe that the information is true, accurate, and complete. I am aware that there are significant penalties for submitting false information, including the possibility of fine and imprisonment. (Ref. 40 CFR 144.32).

NAME AND OFFICIAL TITLE (Please type or print)

SIGNATURE

DATE SIGNED



UNITED STATES ENVIRONMENTAL PROTECTION AGENCY
WASHINGTON, DC 20460

ANNUAL DISPOSAL/INJECTION WELL MONITORING REPORT

NAME AND ADDRESS OF EXISTING PERMITTEE

NAME AND ADDRESS OF SURFACE OWNER

LOCATE WELL AND OUTLINE UNIT ON SECTION PLAT — 640 ACRES

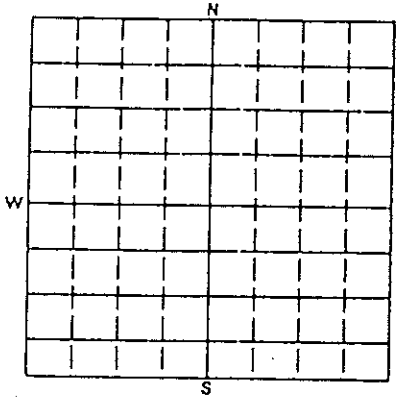

STATE _____ COUNTY _____

PERMIT NUMBER _____

SURFACE LOCATION DESCRIPTION

____ 1/4 of ____ 1/4 of ____ 1/4 of ____ 1/4 of Section ____ Township ____ Range ____

LOCATE WELL IN TWO DIRECTIONS FROM NEAREST LINES OF QUARTER SECTION AND DRILLING UNIT

Surface Location ____ ft. from (N/S) ____ Line of quarter section

and ____ ft. from (E/W) ____ Line of quarter section

WELL ACTIVITY TYPE OF PERMIT

- Brine Disposal Individual
 Enhanced Recovery Area
 Hydrocarbon Storage Number of Wells ____

Lease Name _____

Well Number _____

INJECTION PRESSURE

TOTAL VOLUME INJECTED

TUBING — CASING ANNULUS PRESSURE
(OPTIONAL MONITORING)

MONTH	YEAR	AVERAGE PSIG	MAXIMUM PSIG	BBL	MCF	MINIMUM PSIG	MAXIMUM PSIG

CERTIFICATION

I certify under the penalty of law that I have personally examined and am familiar with the information submitted in this document and all attachments and that, based on my inquiry of those individuals immediately responsible for obtaining the information, I believe that the information is true, accurate, and complete. I am aware that there are significant penalties for submitting false information, including the possibility of fine and imprisonment. (Ref. 40 CFR 144.32).

NAME AND OFFICIAL TITLE (Please type or print)

SIGNATURE

DATE SIGNED





APPENDIX C

Examples of UIC Class II Well Applications.....	C-7
Example of Draft Permit Cover Letter.....	C-28
Example of a Permit for a New Well – Part I & Part III (Special Conditions).....	C-30
Example of a Public Notice to Issue a Permit.....	C-39
Example of Statement of Basis.....	C-41

Form Approved OMB No 2040-0042 Expires 9-30-86

4



UNITED STATES ENVIRONMENTAL PROTECTION AGENCY
UNDERGROUND INJECTION CONTROL
PERMIT APPLICATION
(Collected under the authority of the Safe Drinking
Water Act, Sections 1421, 1422, 40 CFR 144)

Form Approved OMB No 2040-0042 Expires 9-30-86

I. EPA ID NUMBER
T/A C

UIC

READ ATTACHED INSTRUCTIONS BEFORE STARTING
FOR OFFICIAL USE ONLY

Application approved Date Received Permit/Well Number Comments

II. FACILITY NAME AND ADDRESS III. OWNER/OPERATOR AND ADDRESS
Facility Name J. Barth #1 Owner/Operator Name D. Oil Company
Street Address Well Address Street Address Company
City State ZIP Code City State ZIP Code

IV. OWNERSHIP STATUS (Mark 'x') V. SIC CODES
 A. Federal B. State C. Private
 D. Public E. Other (Explain) 1300

VI. WELL STATUS (Mark 'x')
 A. Operating Date Started B. Modification/Conversion C. Proposed

VII. TYPE OF PERMIT REQUESTED (Mark 'x' and specify if required)
 A. Individual B. Area Number of Existing wells Number of Proposed wells Name(s) of field(s) or project(s)

VIII. CLASS AND TYPE OF WELL (see reverse)
A. Class(es) (enter code(s)) II B. Type(s) (enter code(s)) R
C. If class is "other" or type is code 'x,' explain D. Number of wells per type (if area permit)

IX. LOCATION OF WELL(S) OR APPROXIMATE CENTER OF FIELD OR PROJECT X. INDIAN LANDS (Mark 'x')
A. Latitude B. Longitude Township and Range
C. Deg Min Sec Deg Min Sec Twsp Range Sec 1/4 Sec Feet from Line Feet from Line Yes No

XI ATTACHMENTS
(Complete the following questions on a separate sheet(s) and number accordingly; see instructions)
FOR CLASSES I, II, III (and other classes) complete and submit on separate sheet(s) Attachments A - U (pp 2-6) as appropriate. Attach maps where required. List attachments by letter which are applicable and are included with your application:

XII. CERTIFICATION
I certify under the penalty of law that I have personally examined and am familiar with the information submitted in this document and all attachments and that, based on my inquiry of those individuals immediately responsible for obtaining the information, I believe that the information is true, accurate, and complete. I am aware that there are significant penalties for submitting false information, including the possibility of fine and imprisonment. (Ref. 40 CFR 144.32)

Name and Title (Type or Print) Must be a responsible corporate officer or a representative (authorized by that person in writing) who has responsibility for the overall operation of the facility.
C. Signature B. Phone No. (Area Code and No.)
D. Date Signed

Attachment A: Area of Review

The area of review shall be of a fixed radius of no less than 1/4 mile from the well bore.

Attachment B: Maps of wells in Area of Review
See following page.

Attachment C: Corrective Action Plan

Should upward fluid migration occur through the well bore of any previously unknown, improperly plugged or unplugged well due to injection of permitted fluids, injection will be shut-in until proper plugging can be accomplished. Should any problem develop in the casing of the injection well, injection will be shut-in until such repairs can be made as to remedy the situation.

Tabulation of wells penetrating the injection zone:

<u>#</u>	<u>Well Name</u>	<u>Well Type</u>	<u>Operator</u>	<u>Date Drilled</u>	<u>Total Depth</u>
1.	J. Barth #1	Conversion to injection	D. Oil Co.	12/9/81	3670'
	(Construction details are in Attachment L.)				
2.	F. Miller #1	Oil Well	D. Oil Co.	1/13/82	3600'
	8 5/8" 24#, K-55 casing set at 670' cemented with 450 Sx Class A 5 1/2" 14#, K-55 casing set at 3600', cemented with 450 Sx Class A Perfs 3613-59' 3544-92', Stim. 3600g 20% NEHC1				
	(Well Completion report is in appendix)				
3.	E. Brent #1	Dry hole	No Name Oil Co.	5/15/38	3559'
	(Well Completion report and plugging affidavit are in appendix)				
4.	F. Miller #2	Dry hole	D. Oil Co.	6/10/55	3600'
	(Well Completion report and plugging affidavit are in appendix).				

Attachment B
 Maps of Wells and Area of Review

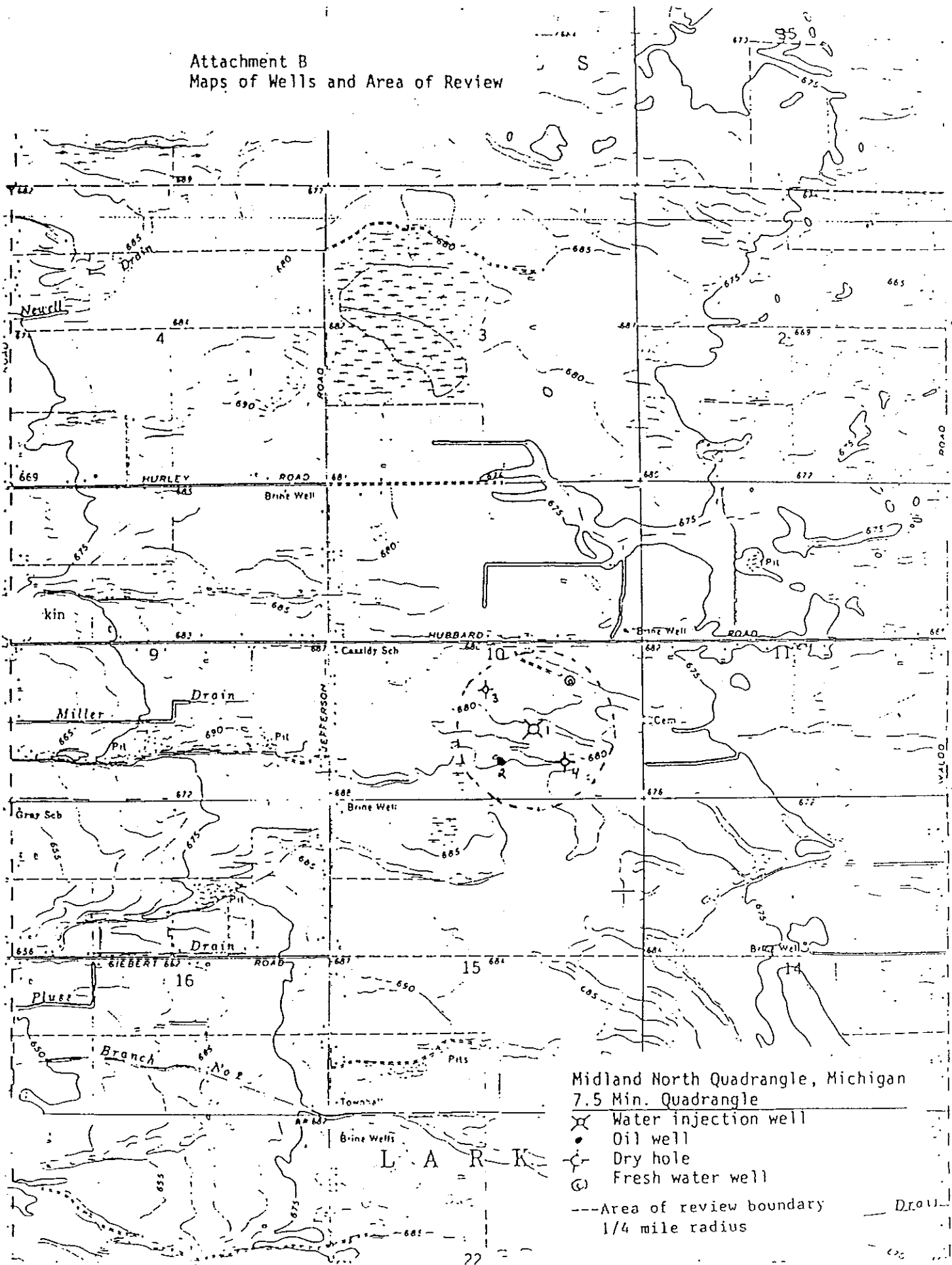

Midland North Quadrangle, Michigan
 7.5 Min. Quadrangle

- ⊗ Water injection well
- Oil well
- ⊖ Dry hole
- ⊙ Fresh water well

--- Area of review boundary
 1/4 mile radius

Attachment E: Name and Depth of USDWs

The majority of the underground sources of drinking water (USDWs) in the area occur in the glacial drift. In this area, the drift ranges in thickness from 280' to 350'. The aquifers occur as lenses of sand and gravel interbedded with the abundant clay of the drift. These lenses are generally thin (10' to 40' thick) and are more abundant in the upper 200' of the drift. Within the area, domestic water wells are generally less than 100' deep.

Immediately below the drift occurs the Grand River Formation of the Pennsylvanian Conemaugh Series. This formation is characterized by coarse sandstones including some shales, sandy shales and occasional gypsum and limestone beds. The main aquifer of the Grand River formation is limited to the lower +110' of sand development, with the base being +520'. The water quality for this aquifer is marginal and any aquifer below +520' would be considered unsuitable for drinking water.

Strata below the Pennsylvanian contain greater than 10,000 ppm total dissolved solids and therefore do not qualify as USDWs. (Reference: Hydrogeologic Atlas of Michigan, Western Michigan University, 1981).

Attachment G: Geological Data on Injection and Confining Zones

Within the No Name field, the Dundee is overlain by the Bell Shale and underlain by anhydrite of the Detroit River Group. The top of the Dundee occurs at a depth of +3550' and has an average thickness of 240'. The Dundee is composed dark gray to light brown limestones, ranging from grainstones to packstones. With the fracture gradient for the area being 1 psi/ft, (See Attachment I) the fracture pressure for the Dundee would be approximately 3550 psig.

The porosity interval, in which water will be injected, occurs +30' from the top of the Dundee and ranges in thickness from 10' to 90'. This zone is confined at the top by the 30' of tight, dark gray limestone of the Dundee and the +60' of Bell Shale. The base of the zone is defined by the loss of porosity by the infilling of vugs with calcite and dolomite cement and is ultimately confined by the anhydrite of the Detroit River Group.

The Traverse occurs between the top of the Bell Shale and the first clean limestone below the base of the Antrim Shale. The Traverse occurs at a depth of +2930' and has an average thickness of 550'. Lithologically, the Traverse consists of limestone and shale with minor amounts of dolomite. Two shale intervals, 30' and 4' thick, consistently occur in the upper 100' of the Traverse, while the lower 200' becomes increasingly shaly as the Traverse grades into the Bell Shale.

Attachment H: Operating Data

Injection Rates and Volumes

The proposed average injection rate is to be 100 BBLS of water per day. The maximum anticipated rate should be no greater than 500 BBLS of water per day.

Injection Pressures

Injection pressures are anticipated to be low, primarily in the 100 psig to 200 psig range. This pressure will be due primarily to friction pressure in the piping system. It is anticipated that the bottom hole pressure would never increase beyond 800 - 900 psig. This is anticipated relative to the data known on the Dundee interval. The maximum well head pressure calculated using the formula published in 40CFR §147.1153 would be $(1 - .433 \times 1.08) 3580' = 1983$ psia. This is based on a fracture gradient of 1.0. However, it is not anticipated that this pressure will ever be reached based on core data, operating history, and experience in the field.

Nature of The Annulus Fluid

The annulus fluid which will be used is Tretolite's XC-320. This fluid is a liquid polyamine and works as a biocide and corrosion inhibitor. The anticipated ratio will be 5 gal. of XC-320 to 4200 gals of fresh water. Documents which list the general description and common treatments utilized are in the appendix. The compound is listed under E.P.A. registration number 5009-4. A positive pressure will be maintained on the annulus for purpose of monitoring mechanical integrity.

Source and Analysis of Injection Fluid

Please see attached sheet.

There are no significant problems relative to the fluids to be used for the injection stream. The fresh water makeup water will be utilized and blended with produced water for reinjection. An analysis of the produced water is provided in the appendix. The injection fluid will ultimately be composed of 7:3, fresh: produced water.

Attachment 1: Formation Testing Program

1) Fluid Pressure

Bottom hole pressures have been determined from at least 5 wells in the Dundee in the No Name Field. Pressure build-ups were recorded either by Amerada Hess pressure recorders or by acoustic well-sounders that determine fluid levels in wells. Reservoir pressure ranges from a high of 747 psig at the edge of the field to a low of 138 psig in the center of the east half of the field. Average reservoir pressure in the west half of the field is approximately 300 psig and average reservoir pressure in the east half of the field is approximately 200 psig. The results of Drill-Stem testing are in the appendix.

2) Fracture Pressure

The fracture gradient in the Dundee is 1 psig/ft calculated from a step-rate injectivity test. Test results and calculations are in the appendix. A fracture gradient of 1 psig/ft gives a reservoir fracture pressure of 3550 psig for the Dundee. This gives a surface injection pressure of 2013 psig for the Dundee (assuming a fresh water column of fluid).

3) Physical Characteristics

The Dundee has been cored in 3 wells in the No Name Field and porosities and permeabilities have been measured in the lab (results are in the appendix). Average porosity is 7.27% and geometric average permeability is 15.6 md. Arithmetic average permeability is 184 md. The Dundee can be described as highly vugular with a low matrix porosity. A combination of fenestral vugs, root casts, and moldic porosity as well as a small amount of porosity from fractures associated with the numerous stylolites makes up the vugular porosity while the low matrix porosity is mostly intercrystalline. A water/oil contact exists in the Dundee at - 2930' (subsea). No original gas cap existed in the Dundee.

Formation Testing Program

4) Chemical Characteristics

The Dundee is a limestone. A mineralogical analysis of the Dundee in several wells was performed. The samples were ground whole and mounted for x-ray diffraction. The mineral contents were calculated as percentages of the whole sample and are shown below:

<u>Sample</u>	<u>Calicte</u>	<u>Dolomite</u>	<u>Quartz</u>	<u>Pyrite</u>
1	96	--	2	2
2	97	--	1	2
3	95	--	2	3
4	96	--	2	2
5	95	2	2	1

- 5) A copy of a water analysis report of formation fluid from the Dundee is in the appendix.

Attachment J: Stimulation Program

Stimulation Procedure

Well Converted from Producer to Injector

No Change in Open Section:

1. Run tubing and packer below open interval.
2. Spot sufficient 15% non emulsifying, iron-stablized HCL acid mixed in suitable solvent to cover perforated interval.
3. Raise tubing and packer to a point 100' above the top perforation.
4. Reverse circulate with 1.25 times tubing volume or until all acid has been displaced from annulus and from tubing.
5. Pump 50 gallons per foot of open interval acid-solvent as in Step 2 down tubing to within 250 feet of the packer; set packer.
6. Displace 50 gal./ft. of acid-solvent as in Steps 2 and 5 to perforations.

Attachment 1: Construction Details

WELL NAME: J. Barth #1

LOCATION: NE 1/4 SW 1/4 SE 1/4
Sec 10 T15N R2E

DEPARTMENT OF NATURAL RESOURCES PERMIT NUMBER:

DATE DRILLING BEGAN: 12/9/81

DATE COMPLETED: 12/17/81

DRILLING TECHNIQUE: CABLE ROTARY

TOTAL DEPTH: 3670'

COMPLETION INFORMATION: Perforations: 3566-73' 2SPF
1/13/82 Acidized 3566-73' W/ 1500 Gal 20% NEHCL
IP 16B0/1BW

CASING RECORD: 8 5/8" 24# K-55 @656' W/400 SX
5 1/2" 14# J-55 @3670' W/500 SX

OPEN HOLE

INTERVAL:

CASED HOLE

PERFS: 3580-3590 2SPF

PRESENT STATUS: Pumping Electric - Producing
(will be converted to injector)

OTHER DATA:

ATTACHMENTS: See Well Sketch

7. If diverters are necessary use 8# of graded rock salt (NaCl) per perforation in as many stages as are deemed necessary. Rock salt to be mixed with gelled saturated salt (NaCl) water. If open hole in interval is to be temporarily blocked use 16# per foot of graded rock salt (NaCl).
8. Allow 30 minutes for acid to spend an swab back load and acid water.
9. Prepare well for injection.

Attachment K: Injection Procedures

1. A 1", 2-cartridge Nowata Waterfilter is located between the injection pump and the well head. The manufacturer's literature is in the appendix.
2. The selected injection pump is a Cat 318 with an injection capacity of 4 gal/minute maximum. The manufacturers literature is in the appendix.
3. The water supply storage tank is located next to the injection well and is a 100 bbl. fiberglass tank manufactured by Biguard. Produced water and extraneous makeup water will be mixed in this tank prior to injection.

Attachment L: Construction Procedures

- 1) The #1 J. Barth was drilled to a depth of 3670'.
- 2) The well was completed as an oil well and perforated at 2 shots per foot thru casing from 3580-3590.
- 3) 8-5/8" inch surface casing (K-55; 24 lb. weight) was set at 656' in a 12/4" hole. No centralizers or scratchers were used.
- 4) No intermediate casing is run in this location.
- 5) The long string casing is 5 1/2" J-55 type; 14 lbs weight and was set at 3670' in a 7 7/8" hole. Eleven centralizers were used and were located at 167, 587, 1000, 1841, 2264, 2553, 2811, 2898, 3107, 3274 and 3500'.
- 6) No liner or "other" casing was run in this location:
- 7) No logs were run on the (open) surface hole before or after surface casing installation since the lithology is well known in this area.

Well Completion Sketch

well	Field	Date
J. Barth #1	No - Name	7/25/84

Present Completion

Suggested Completion

16" Drive pipe @ 40'

8 5/8" 24# CSG @ 656'
CMT'D w/400 sacks
Class A CMT.

TOC @ 1900' CALC.

5 1/2", 14# @ 3670'
CMT'D w/500 Sacks
Class A CMT

PBTD - 3668'
TD - 3670

2 3/8", 4.7#, 8RD EUE
Tubing @ 3500'

Baker MOD. AD-1 Packer
@ 3500'

PERFS: 3580' - 90'
2 SPF

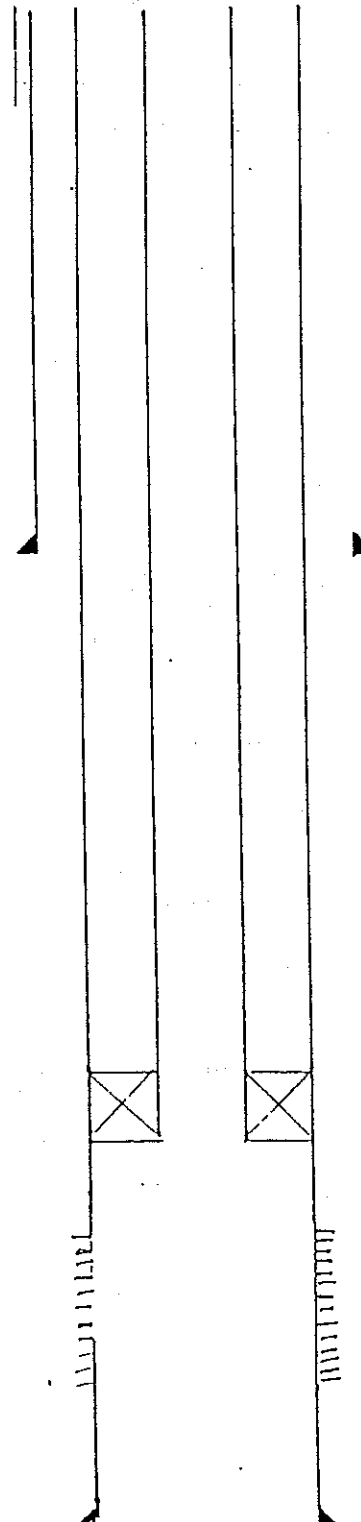

Attachment M
Well Head Sketch

PIPE		BOLT SETS		SPECIAL BOLTING		GASKETS		MISCELLANEOUS	
ITEM	DESCRIPTION	ITEM	DESCRIPTION	ITEM	DESCRIPTION	ITEM	DESCRIPTION	ITEM	DESCRIPTION
1	3 1/2" 20#	41	1/2" 20#	46	1/2" 20#	36	1/2" 20#	42	1 WELCH HEAD
2	2" 20#	42	3/8" 20#	47	3/8" 20#	37	3/8" 20#	43	1 PRESSURE GAUGE
3	1 1/2" 20#	43	1/4" 20#	48	1/4" 20#	38	1/4" 20#		
4	1" 20#	44	3/16" 20#			39	3/16" 20#		
5	3/4" 20#	45	1/8" 20#			40	1/8" 20#		
6	1/2" 20#	46	3/32" 20#			41	3/32" 20#		
7	3/8" 20#	47	1/16" 20#			42	1/16" 20#		
8	1/4" 20#	48	3/64" 20#			43	3/64" 20#		
9	3/16" 20#					44	3/64" 20#		
10	1/8" 20#					45	3/64" 20#		
11	3/32" 20#					46	3/64" 20#		
12	1/16" 20#					47	3/64" 20#		
13	3/64" 20#					48	3/64" 20#		
14	1/32" 20#					49	3/64" 20#		
15	1/64" 20#					50	3/64" 20#		
16	1/128" 20#					51	3/64" 20#		
17	1/256" 20#					52	3/64" 20#		
18	1/512" 20#					53	3/64" 20#		
19	1/1024" 20#					54	3/64" 20#		
20	1/2048" 20#					55	3/64" 20#		
21	1/4096" 20#								
22	1/8192" 20#								
23	1/16384" 20#								
24	1/32768" 20#								
25	1/65536" 20#								
26	1/131072" 20#								
27	1/262144" 20#								
28	1/524288" 20#								
29	1/1048576" 20#								
30	1/2097152" 20#								
31	1/4194304" 20#								
32	1/8388608" 20#								
33	1/16777216" 20#								
34	1/33554432" 20#								
35	1/67108864" 20#								
36	1/134217728" 20#								
37	1/268435456" 20#								
38	1/536870912" 20#								
39	1/1073741824" 20#								
40	1/2147483648" 20#								
41	1/4294967296" 20#								

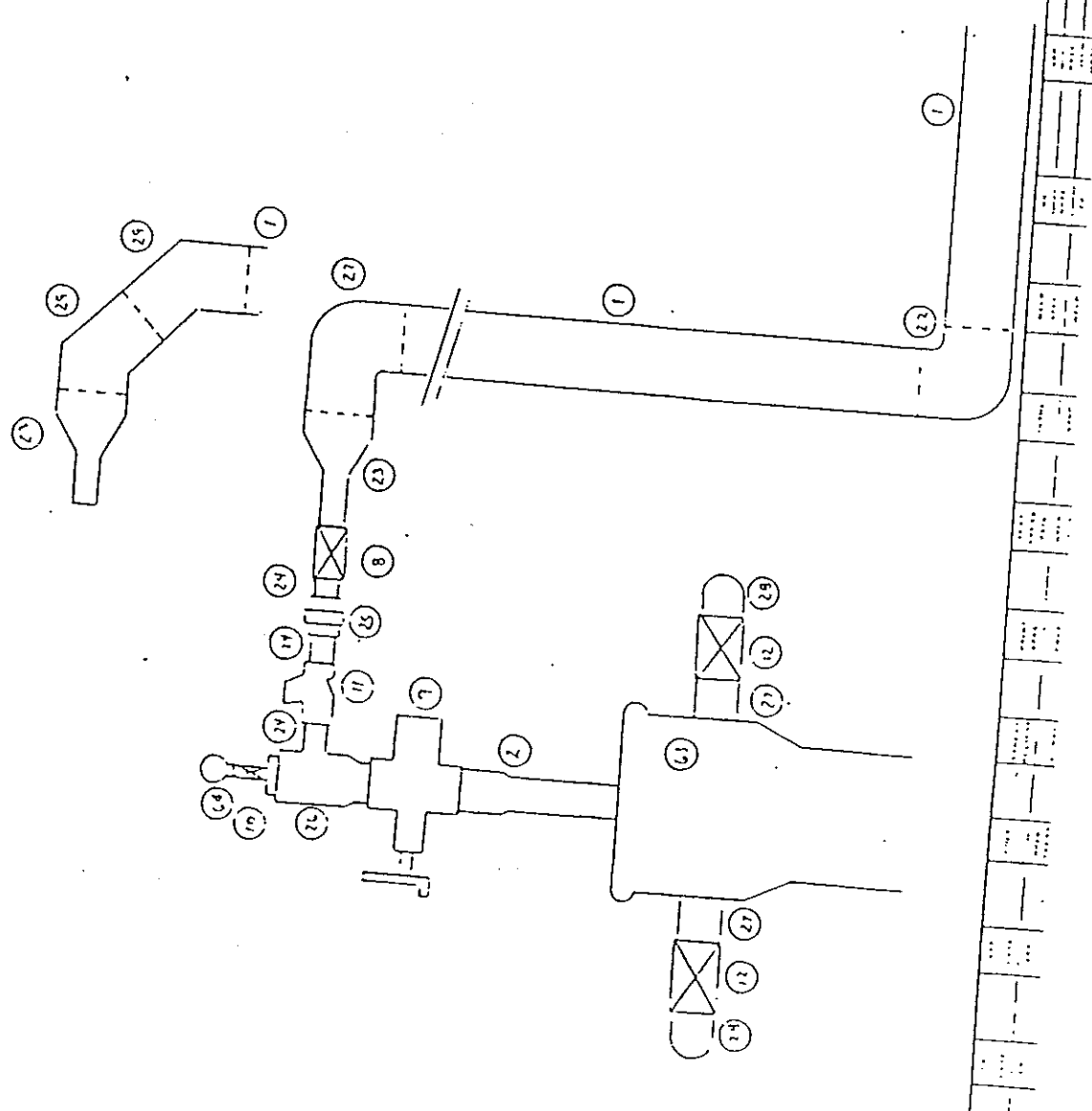

A Dual Induction - Laterolog including spontaneous potential, resistivity, and gamma ray traces was run and is included in the appendix, with formation tops marked.

No porosity log; no directional or inclination survey; and no fracture finder log were run.

A gamma ray - collar locator log was run after casing was installed. A cement bond log was run and is included with interpretation in the appendix.

- 8) Surface casing was cemented in place at 656' using 400 sacks of Class A cement. A copy of the service invoice is included in the appendix. Cement was circulated to completely fill the annulus behind the pipe.

The long string was cemented in place at 3670 feet using 500 sacks of Class A cement. The cement was circulated to surface and had sufficient overfill to insure a good bond. Copies of the job log and summary, etc. are in the appendix.

An annulus pressure test has been run where 500 psi was build up and held for 24 hours. The mechanical integrity of the well was maintained through the test. A copy of the strip chart run during the test is in the appendix.

9. The 2-3/8 inch tubing used (EUE and J-55 type) is 3500' in length.
- 10) A Baker type AD-1 Packer was set at 3500'. Manufacturer's information is available in the appendix.

Attachment M: Construction Details

An illustration of the well construction and well head equipment follows.

Attachment O: Plans for Well failures

If a well failure is detected, the well will be shut-in until the faulty equipment is replaced and the well returned to a safe operating condition. If the failure and operation pose no environmental hazard, then nothing further will be done.

In the case of casing leaks or some other major failure, the well will be shut-in and the Department of Natural Resources and EPA will be contacted. The well will remain shut-in until the condition is corrected. This correction will involve squeezing off the leak with cement or replacing the bad casing. The well will not be returned to active status until its integrity has been determined. Any fluid produced during injection well shut-in will either be stored on site or removed by a commercial disposer depending on the amount produced.

Attachment P: Monitoring Program

This project shall be monitored throughout its entire life. All EPA monitoring guidelines and minimum reporting requirements shall be complied with.

- a) a quarterly analysis and report by an independent laboratory shall be completed on the injected fluids. The sampling location shall be at the 1/2 inch needle valve at the well head.
- b) the injection pressure and annulus pressure will be monitored weekly and reported monthly.
- c) the flow rate will be monitored weekly and reported monthly
- d) the cumulative volume shall be monitored weekly and reported monthly.

Monthly reports shall be given over to the EPA at the end of each monthly period as soon as data is received (no later than the 10th day of the following month).

Attachment Q: Plugging and Abandonment Procedure

1. Move in and rig up workover rig. Kill well as necessary with lease water.
2. Nipple up blowout preventer and test pipe rams to 1000 psi.
3. Pull out of hole with 2-3/8" tubing and packer.
4. Run in hole with cement retainer on 2-3/8" tubing. Set cement retainer ±50' above top perforation in Dundee. Establish injection rate into perforations with fresh water and squeeze perforations with 40 sacks Class "A" cement (wt 15.7 ppg; yield 1.18 cf/sk) through retainer.
5. Stab out of retainer and leave 10 sx cement on top of retainer (+86 linear feet).
6. Pull up to 750' (100' below surface casing shoe depth). Spot 25 sacks of same cement from 750-535'.
7. Pull up to 50'. Spot 10 sacks cement to surface. Pull out of hole with tubing.

8. Cut off 8-5/8" & 5-1/2" casing 4' below ground level. Weld 1/2" steel plate on 5-1/2" casing stub.
9. Backfill and clean up location.

PLUGGING AND ABANDONMENT COSTS

	\$
Workover Rig (including rig move) (\$120/hr)	\$3600
Cementing & Service	\$2200
Rentals (BOP & FW tank)	\$ 650
Water Transportation	\$ 350
Welder	\$ 250
Supervision	\$ 900
Cement Retainer	\$1250
Surface Restoration	\$ 500
TOTAL P&A COSTS	\$9700

A signed copy of the EPA Plugging and Abandonment Plan is attached.

Attachment R:

Attached is a Surety Performance bond in the amount of estimated plugging costs, with the U.S. EPA as beneficiary. Also attached is the Standby Trust Agreement required to accompany bonds to EPA.

Attachment U: Description of Business

J.D. Oil Company is involved in the exploration, production, and marketing of crude oil and natural gas.

A List of names and addresses of all owners of record of land within 1/4 mile of the facility boundary is in the appendix.

The appendix would include:

1. Well completion reports and plugging affidavits for wells in the area of review.
2. Documents describing the annulus fluid.
3. Injection fluid analysis
4. Drill - Stem test results
5. Step-rate injectivity test results and calculations of fracture gradient.
6. Core data.
7. Formation fluid analysis
8. Manufacturer's literature on filter and pump.
9. Dual-Induction-Laterolog and cement bond log, with interpretations.
10. Cementing invoices and job log.
11. Pressure test results.
12. Manufacturer's specifications for tubing and packer.
13. Names and addresses of owners of record.



UNITED STATES ENVIRONMENTAL PROTECTION AGENCY
WASHINGTON, DC 20460

PLUGGING AND ABANDONMENT PLAN

NAME AND ADDRESS OF FACILITY J. Barth #1 Facility Address	NAME AND ADDRESS OF OWNER/OPERATOR D. Oil Company Company Address
-----------------------------------------------------------------	-------------------------------------------------------------------------

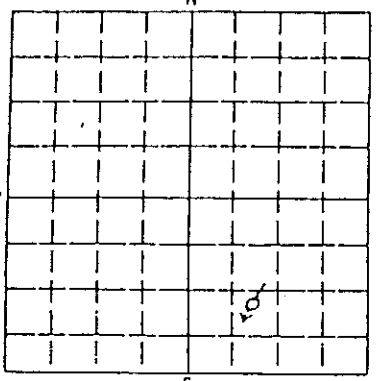
LOCATE WELL AND OUTLINE UNIT ON SECTION PLAT — 840 ACRES 	STATE MI	COUNTY Midland	PERMIT NUMBER
	SURFACE LOCATION DESCRIPTION NE 1/4 OF SW 1/4 OF SE 1/4 SECTION 10 TOWNSHIP 15N RANGE 2-E		
	LOCATE WELL IN TWO DIRECTIONS FROM NEAREST LINES OF QUARTER SECTION AND DRILLING UNIT Surface Location 300 ft. from (N/S) N Line of quarter section and 300 ft. from (E/W) E Line of quarter section		
	TYPE OF AUTHORIZATION <input checked="" type="checkbox"/> Individual Permit <input type="checkbox"/> Area Permit <input type="checkbox"/> Rul. Number of Wells <u>1</u>	WELL ACTIVITY <input type="checkbox"/> CLASS I <input checked="" type="checkbox"/> CLASS II <input type="checkbox"/> Brine Disposal <input checked="" type="checkbox"/> Enhanced Recovery <input type="checkbox"/> Hydrocarbon Storage <input type="checkbox"/> CLASS III	

CASING AND TUBING RECORD AFTER PLUGGING					METHOD OF EMPLACEMENT OF CEMENT PLUGS	
SIZE	WT(LB/FT)	TO BE PUT IN WELL (FT)	TO BE LEFT IN WELL (FT)	HOLE SIZE	<input checked="" type="checkbox"/> The Balance Method <input type="checkbox"/> The Dump Bailer Method <input type="checkbox"/> The Two-Plug Method <input type="checkbox"/> Other	
8-5/8	24#	656'	656'	12-1/4"		
5-1/2	14#	3670'	3670'	7-7/8"		

CEMENTING TO PLUG AND ABANDON DATA		PLUG #1	PLUG #2	PLUG #3	PLUG #4	PLUG #5	PLUG #6	PLUG #7
Size of Hole or Pipe in which Plug Will Be Placed (inches)		5-1/2"	5-1/2"	5-1/2"	5-1/2"			
Depth to Bottom of Tubing or Drill Pipe (ft)		+3500	+3500	+750'	+50'			
Sacks of Cement To Be Used (each plug)		40	10	25	10			
Slurry Volume To Be Pumped (cu ft)		47	12	30	12			
Calculated Top of Plug (ft)		+3500	+3414'	+535	Surface			
Measured Top of Plug (if tagged ft)		N/A	N/A	N/A	Surface			
Slurry Wt. (Lb /Gal)		15.6	15.6	15.6	15.6			
Type Cement or Other Material (Class III)		Class A	Class A	Class A	Class A			

-LIST ALL OPEN HOLE AND/OR PERFORATED INTERVALS AND INTERVALS WHERE CASING WILL BE VARIED (If any)			
From	To	From	To

Estimated Cost to Plug Wells
\$9,700

CERTIFICATION

I certify under the penalty of law that I have personally examined and am familiar with the information submitted in this document and all attachments and that, based on my inquiry of those individuals immediately responsible for obtaining the information, I believe that the information is true, accurate, and complete. I am aware that there are significant penalties for submitting false information, including the possibility of fine and imprisonment. (Ref. 40 CFR 144.32)

NAME AND OFFICIAL TITLE (Please type or print) Same Signatory as for Permit Application	SIGNATURE _____	DATE SIGNED Date
--------------------------------------------------------------------------------------------	--------------------	---------------------

Water Injection Permit Application

TABLE OF CONTENTS

- I. PERMIT APPLICATION
- II. ATTACHMENTS A THROUGH U
- III. APPENDICES
 - A. Topographic Map
 - B. Well Location Map
 - C. Well Logs
 - D. Water Analyses
 - E. Well Construction Sketch
 - F. Plugging and Abandonment Plans
 - G. Necessary Resources

Water Injection Permit Application

ATTACHMENT A: AREA OF REVIEW

Attached is a topographic map with a fixed radius of a 1/4 mile from the water injection well. (See Appendix A)

Class II-R

ATTACHMENT B: MAPS OF WELLS AND AREA OF REVIEW

Please refer to the topographic map in Appendix A for the Area and Area of Review. A map showing the surrounding wells (all outside the area of review) can be found in Appendix B.

The following DO NOT fall within the Area of Review:

- 1) Hazardous waste, treatment or disposal facilities
- 2) Rivers
- 3) Quarries
- 4) Faults
- 5) Domestic Water Wells
- 6) Permanent Residences

A drainage ditch, which dries up in the summer months, passes through the Area of Review. There are no wells within the Area of Review.

ATTACHMENT C: CORRECTIVE ACTION PLAN

Should upward fluid migration occur through the well bore of any previously known or unknown, improperly plugged or unplugged wells due to injection of permitted fluids, injection will be shut-in and proper authorities notified, until proper plugging can be accomplished. Should any migration problems develop inside the casing of the injection well, injection will be shut-in immediately until repairs can be made to correct the problem. The proper authorities will also be timely notified of any such conditions.

ATTACHMENT D: MAPS AND CROSS SECTIONS OF USDW's

This application requirement does not apply to Class II wells.

ATTACHMENT E: NAME AND DEPTH OF USDW's

The lowest known USWD is Sandstone the bottom of which is at a depth of 100'

Water Injection Permit Application

ATTACHMENT F: MAPS AND CROSS SECTIONS OF GEOLOGIC STRUCTURE OF AREA

Not required for Class II wells.

ATTACHMENT G: GEOLOGIC DATA ON INJECTION AND CONFINING ZONES

Lower Confining Zone - Not required due to no USDW's below injection zone.

Injection Zones

Cypress sandstone (Approx. 2,373'-2,463' measured depth, 2,009.5'-2,099.5' sub-sea), with Borehole Compensated Density Porosity of 12-18%.

Rosiclare limestone (2,660'-2,670' & 2,678'-2,682' measured depth, 2,296.5'-2,306.5' & 2,314.5'-2,318.5' sub-sea), with Borehole Compensated Density Porosity of 10-15%.

Upper Confining Zone

Above Cypress (Approx. 2,276'-2,373' measured depth & 1,912.5'-2,009.5' sub-sea) The confining zone is the Barlow Lime through the Upper Cypress, with impermeable lime (Barlow) on top of shale, sandy shale, and shaley sand (Cypress). (See the marked Log in Appendix C)

ATTACHMENT H: OPERATING DATA

Injection Rates and Volumes

Average Expected Volume - 2,000 barrels (84,000 gallons) per day

Maximum Expected Volume - 15,000 barrels (650,000 gallons) per day

Injection Pressures

Initial injection pressure is expected to be approx. 400 psi. The maximum pressure for this well will be 806 psi from the data presented in Attachment I. Should a higher injection pressure be required or desired, a preapproved step-rate-test will be run or acidization or fracture treatment tickets will be provided to determine the formation parting pressure for establishing a higher allowable injection pressure.

Annulus Fluid

The fluid between the tubing and the casing will be a combination of 3 gallons of corrosion inhibitor and 25 bbls. of salt and/or fresh water.

Water Injection Permit Application

Source and Analysis of Injection Fluid

A commingled water consisting of produced water from the Cypress and Rosiclare reservoirs will be injected into the Cypress and Rosiclare reservoirs. (Water Analyses are in Appendix D.)

ATTACHMENT I: FORMATION TESTING PROGRAM

Formation Fluid Pressure

Current formation fluid pressure in the Cypress is 816 psi.

Current formation fluid pressure in the Rosiclare is 1,738 psi.

Formation Fracture Pressure

The formation fracture pressure is 806 psi. well head calculate as follows:

$(0.8\text{-Fluid S.G.}) \times \text{Depth}$

$(0.8-0.46) \times 2,373' = 806.82 \text{ psi.}$

Formation Water Quality

The produced water analyses can be found in Appendix D.

Porosity and Permeability

See values in Attachment G.

ATTACHMENT J: STIMULATION PROGRAM

will be perforated and the perforations will be cleaned up with acid. If necessary, the Cypress sand may be fracture stimulated

ATTACHMENT K: INJECTION PROCEDURE

Produced water will be stored in tanks prior to its flow to a triplex pump, for pressurization, controlled by minimum and maximum fluid level and pressure switches. Following pressurization, the fluid will be transported by high pressure lines to the injection point where the volume and pressure will be monitored along with control valves to adjust the injection rate and pressure.

Water Injection Permit Application

ATTACHMENT L: CONSTRUCTION PROCEDURE

The tubing and packer will be removed from the well. The well will be clean out with cable tools or a power swivel to below the existing Rosiclare perforations. The Cypress will be perforated and evaluated to determine if additional stimulation will be necessary. The Cypress will be stimulated as required. A 4 1/2" tension packer will be run on plastic lined 2" EUE and/or fiberglass tubing to within 50' of the injection zone. The annulus will be protected by corrosion inhibitors in water. An MIT will then be run in the presence of a qualified inspector followed by the well being prepared for injection.

ATTACHMENT M: CONSTRUCTION DETAILS

A. through G. in the schematic drawing in Appendix E.

H. Listed below are the specifications for the casing and tubing:

	<u>4 1/2" Casing</u>	<u>2 3/8" Tubing</u>
Collapse (psi)	4,010	8,100
Internal Yield (psi)	4,790	7,700
Axial Load (lbs.)	132,000	72,000

I. Tubing pull force will be the weight specified by the packer manufacturer above the tubing weight. (Construction details in schematic in Appendix E)

ATTACHMENT N: CHANGES IN INJECTION FLUID

Not required for Class II wells.

ATTACHMENT O: PLANS FOR WELL FAILURES

If a well failure, packer or tubing leak is detected, the well will be shut in until faulty equipment can be repaired or replaced and the well returned to a safe operating condition and an MIT run to insure mechanical integrity prior to restarting. If the failure and operation pose no environmental hazard to USDW's or ground surface then nothing further will be done. In the case of a major failure such as a casing leak, the well will be shut in and the Department of Natural Resources and US EPA will be contacted. This correction could involve squeezing off the leak with cement or running of an additional casing string. The well will not be operated until it has been determined that the problem has been corrected. Any fluids produced during shut-in will be stored in the salt water handling system or injected into other wells until they have reached their capacity at which time the water will be disposed of by a commercial disposer.

Water Injection Permit Application

ATTACHMENT P: MONITORING PROGRAM

The well will be monitored throughout its entire life. All EPA monitoring guidelines and reporting requirements will be complied with. The monitoring point will be at the wellsite for rate and pressure observation.

- 1) An analysis and report by an independent laboratory shall be completed on the injection fluids whenever major changes are made to the fluid.
- 2) The injection pressure will be acquired by a pressure gauge, monitored weekly and reported annually.
- 3) The flow rate will be read from a meter, monitored weekly and reported annually.
- 4) The cumulative volumes will be monitored monthly and reported annually.
- 5) Monitoring records will be kept to show the relationship between injection rates and pressures in order to recognize a failure in the mechanical integrity of the well.

ATTACHMENT Q: PLUGGING AND ABANDONMENT PROCEDURE

- 1) Move in and rig up workover rig.
 - 2) Lay down tubing and packer.
 - 3) Run tubing to bottom and fill the well with Class A cement from bottom to surface in two or more stages*.
 - 4) Cut 4 1/2" and 8 5/8" casing off at 3' below ground level and weld 1/2" steel plate on top of 8 5/8" casing.
 - 5) Backfill and clean up location.
- * If the well is flowing to surface at the time of abandonment, a cast iron bridge plug(s) will be used above the flowing zone(s) so the cement can be placed as described above.

(EPA Plugging and Abandonment Form 7520-14 in Appendix F)

Water Injection Permit Application

ATTACHMENT Q: PLUGGING AND ABANDONMENT PROCEDURE (Continued)

Plugging and Abandonment Costs

Rig on Pulling Unit	\$ 1,400.00
Pump Truck and Cement	2,000.00
Water Hauling	200.00
Trucking	150.00
Labor and Miscellaneous	2,050.00
Total P&A Costs	\$ 5,800.00

ATTACHMENT R: NECESSARY RESOURCES

Necessary resources can be found in Appendix G.

ATTACHMENT S: AQUIFER EXEMPTIONS

The Cypress Sandstone and Rosiclare formations have not and will not serve as sources of drinking water in this area due to their nature as per the enclosed fluid analysis in Appendix D. The waters are of such salinity that it makes treating the waters for human consumption uneconomic and impractical at this time or in the future.

ATTACHMENT T: EXISTING PERMITS

This well has an EPA UIC ID Number of KYS.

There are no other known injection wells in the Area of Review.

ATTACHMENT U: NATURE OF BUSINESS

Company is an oil exploration and producing company engaged in development of oil and gas reserves and operating the same as energy sources.

NOTES:

Name and address of land owner within the 1/4 mile of Area of Review:

<u>Name</u>	<u>Address</u>
Kentucky Department of Fish & Wildlife	#1 Game Farm Road Frankfort, Kentucky 40601

PIPE

- 1) 2" Injection Line
- 2) 2 3/8" Tubing
- 3) 1" High Pressure Hose

VALVES

- 4) 2" Valve
- 5) 1" Valve
- 6) 2" Master Valve
- 7) Throttle Valve
- 8) 1/4" Valve

FITTINGS

- 9) 1" 90° Ell
- 10) 1" Nipple
- 11) 2" Nipple
- 12) 2" Bull Plug
- 13) 2" Tubing Collar
- 14) 2" 90° Ell
- 15) 2" to 1" Swedge
- 16) 1" Union
- 17) 2" Tee

MISCELLANEOUS

- 20) Well Head
- 21) Pressure Gauge Access
- 22) 4 1/2" Casing
- 23) Meter Run

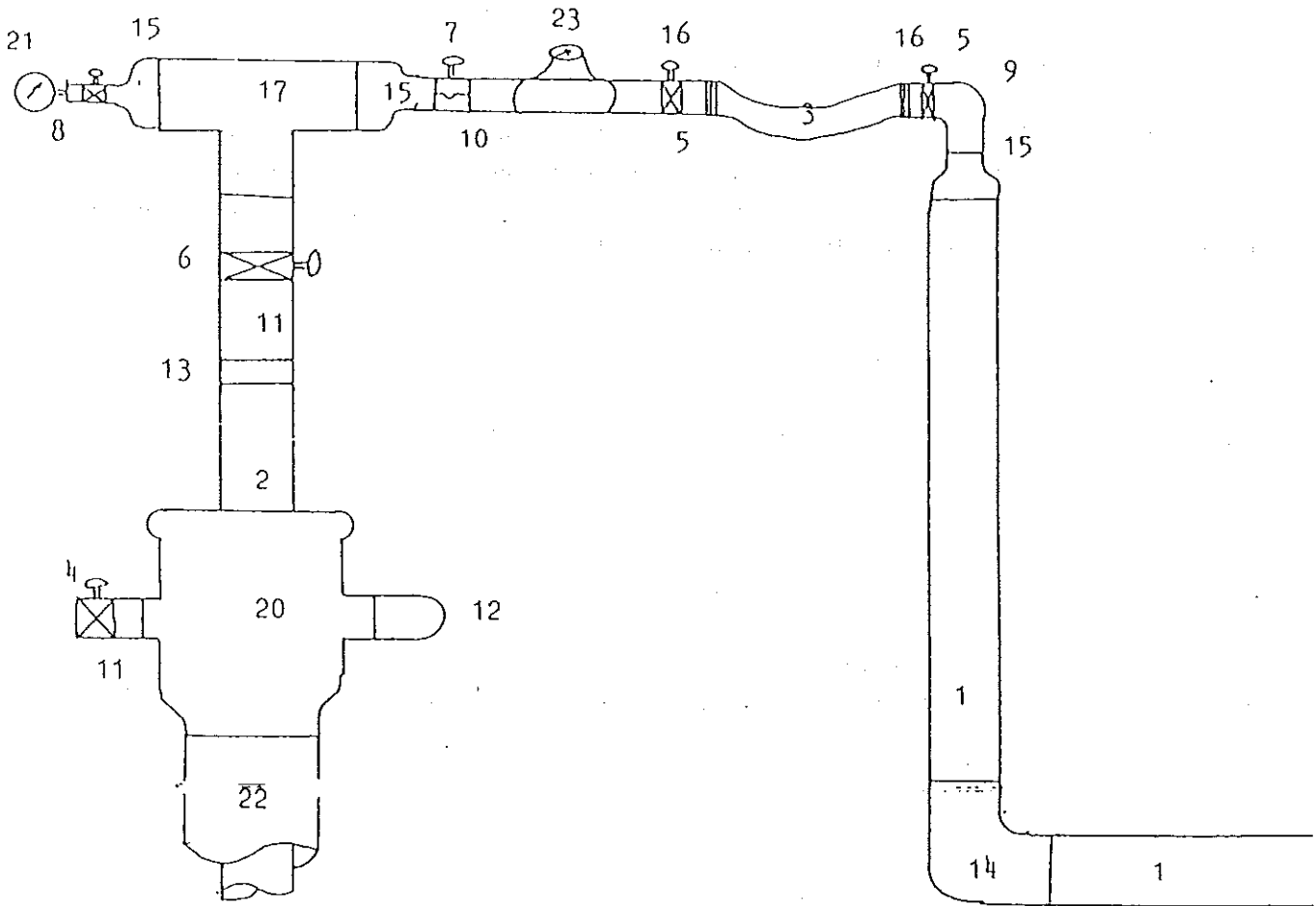

Appendix E Wellbore Schematic

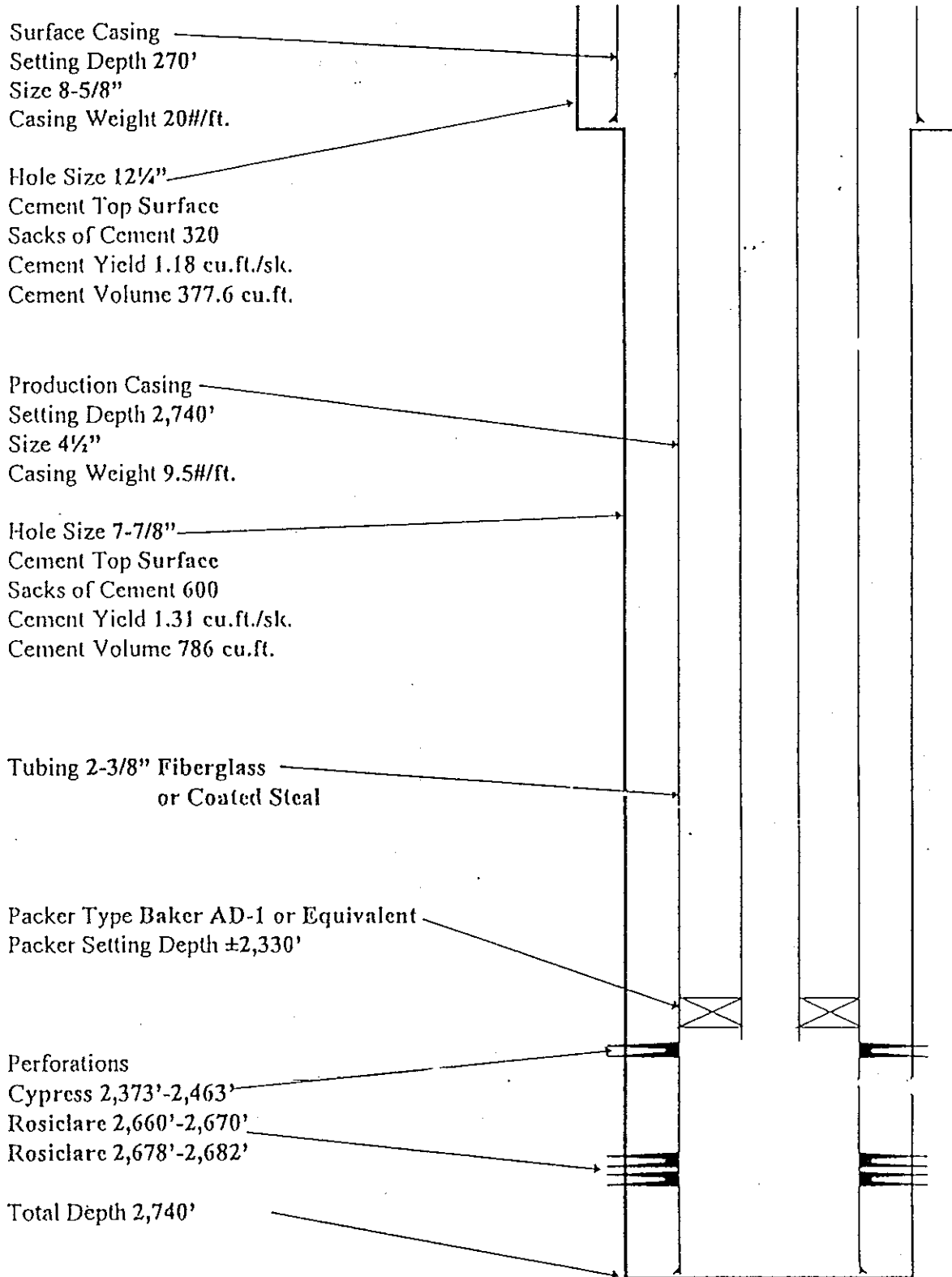

WATER ANALYSIS REPORT

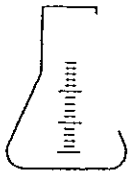

COMPANY: _____ ANALYSIS NO.: 96-333
 LEASE: _____ TYPE WATER: Produced
 STATE: KY SOURCE: Seperator
 COUNTY: Henderson WELL NAME & NO.: _____
 DATE SAMPLED: 09/23/96 ANAL. BY: DM DATE: 9/23/96

MIDWEST CUSTOM CHEMICALS INC., 111 Main Street Suite 203 • P.O. Box 119 • Evansville, IN 47701

ANALYSIS

1. pH	<u>5.8</u>		
2. H ₂ S	<u>5</u>		
3. Specific Gravity	<u>1.061</u>		
4. Dissolved solids	<u>780,069</u>		
5. Suspended solids	<u>-</u>		
6. Phenol Alkalinity	<u>-</u>	as CaCO ₃	mg/l meq/l
7. M.O. Alkalinity	<u>580</u>	as CaCO ₃	
8. Bicarbonate (HCO ₃)		<u>719</u> / 61	<u>12</u> HCO ₃
9. Total Hardness as CaCO ₃	<u>13,000</u>		
10. Calcium (Ca) as CaCO ₃	<u>8,600</u>	× 0.4 =	<u>3440</u> / 20 <u>172</u> Ca
11. Magnesium (Mg) as CaCO ₃	<u>4,400</u>	× 0.24 =	<u>1056</u> / 12.2 <u>87</u> Mg
12. Chlorides (Cl)		<u>47,100</u> / 35.5	<u>1326</u> Cl
13. Sulphates (SO ₄)		<u>2,000</u> / 48	<u>42</u> SO ₄
14. Iron total (Fe)		<u>6</u>	
15. Barium/Strontium		<u>-</u>	
16. Oxygen		<u>2.0</u>	
17. Carbon Dioxide		<u>-</u>	

Compound	Equiv. Wt.	× meq/l	=	mg/l
Ca (HCO ₃) ₂	81.04	<u>12</u>		<u>972</u>
Ca SO ₄	69.07	<u>42</u>		<u>2859</u>
Ca Cl ₂	55.50	<u>118</u>		<u>6549</u>
Mg (HCO ₃)	73.17	<u>-</u>		<u>-</u>
Mg SO ₄	60.19	<u>-</u>		<u>-</u>
Mg Cl ₂	47.62	<u>87</u>		<u>4143</u>
Na HCO ₃	84.00	<u>-</u>		<u>-</u>
Na ₂ SO ₄	71.03	<u>-</u>		<u>-</u>
Na Cl	58.46	<u>1121</u>		<u>65533</u>

Ca	172		12	HCO ₃
Mg	87		42	SO ₄
Na	1121		1326	Cl

Meq/l

× 0.393 = Na 25254 mg/l

Ion	mg/l	factor	Ionic strength
Na	<u>25254</u>	2.2E ⁻⁵	<u>56660</u>
Ca	<u>3440</u>	5.0E ⁻⁵	<u>17200</u>
Mg	<u>1056</u>	8.2E ⁻⁵	<u>8659</u>
Cl	<u>47100</u>	1.4E ⁻⁵	<u>65940</u>
HCO ₃	<u>719</u>	0.8E ⁻⁵	<u>575</u>
SO ₄	<u>2000</u>	2.1E ⁻⁵	<u>4200</u>
Total Ionic Strength			<u>1.53234</u>

SI = pH - P Ca - pAlk - k

Stability Index _____

Attachment M

ORIGINAL WELL CONSTRUCTION DURING OPERATION

PLUGGING AND ABANDONMENT CONSTRUCTION

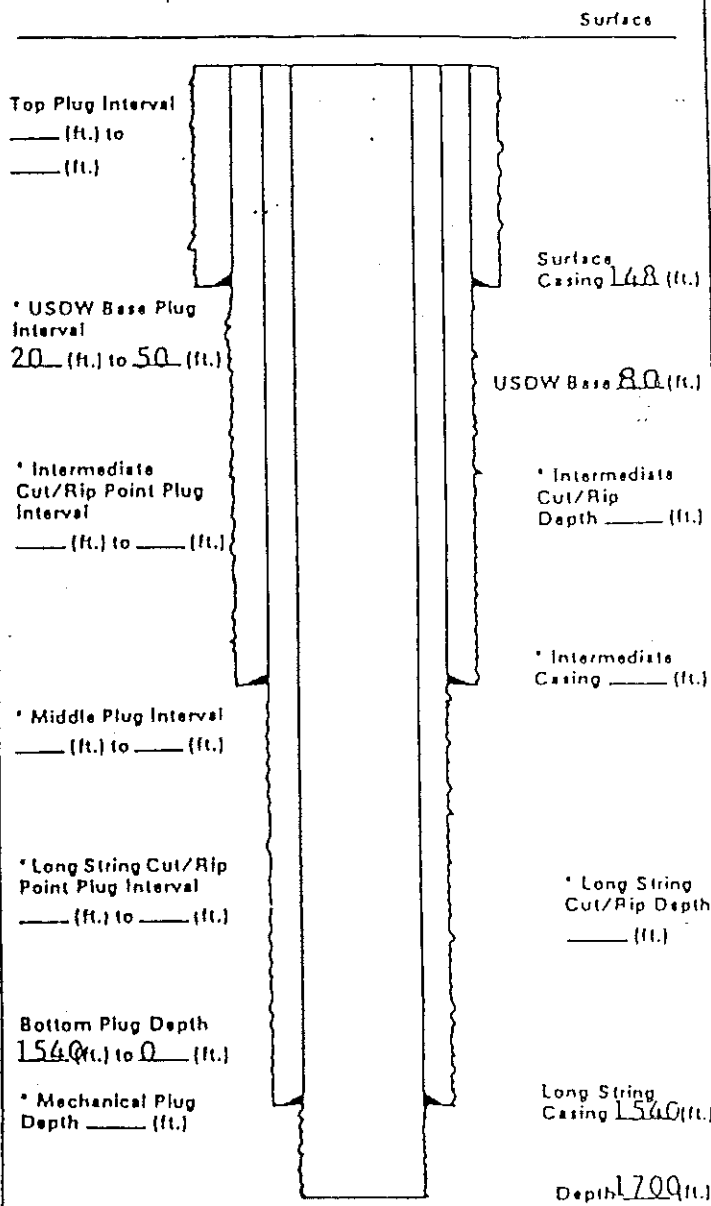
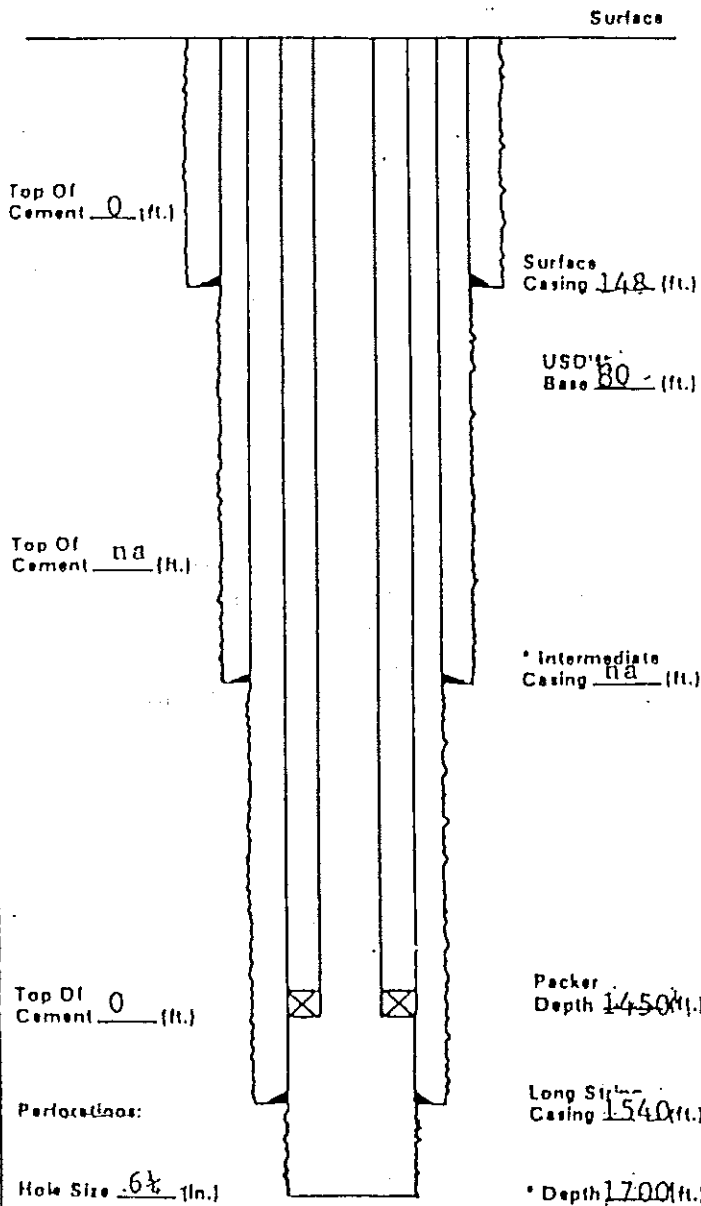

** Add Any Additional Information
* May Not Apply

** Add Any Additional Information
* May Not Apply

LIST OF ALL OPEN AND/OR PERFORATED INTERVALS AND INTERVALS WHERE CASING WILL BE VARIED

Specify Open Hole/Perforations/Varied Casing	From	To	Formation Name
Perforations	1470	1476	Knox Dolomite
	1490	1506	Knox Dolomite
Open Hole	1540	1700	Knox Dolomite



UNITED STATES ENVIRONMENTAL PROTECTION AGENCY
REGION 4
ATLANTA FEDERAL CENTER
61 FORSYTH STREET, SW
ATLANTA, GEORGIA 30303-8909

Example of a Draft Permit Cover Letter

CERTIFIED MAIL
RETURN RECEIPT REQUESTED

REF: 4WM-GWDW

Mr. John Smith
Wilcox Oil Company
120 Oil Field Road
Columbia, KY 42000

SUBJ: UIC Permit Application Number KYI00XX
Permit Writer: XXXXX XXXXX

Dear Mr. Smith:

The U. S. Environmental Protection Agency, Region 4, intends to issue the attached Underground Injection Control (UIC) permit for your facility in accordance with the Safe Drinking Water Act. The enclosed public notice, draft permit and statement of basis show the proposed conditions to be incorporated and the rationale for their inclusion. In order that you understand your responsibilities under the provisions of the attached UIC permit, particular attention should be given to the following sections:

1. Part I. This section contains a listing of operating, monitoring, reporting, and plugging and abandonment requirements specific to your well;
2. Part II. This section contains permit conditions which describe regulatory responsibilities for all Class II injection wells under the UIC permit program;
3. Part III. This section, if included, contains any special conditions not covered in Parts I or II.

If you wish to comment on the draft permit, please submit the comments so that they are received in this office within twenty-five (25) days after receipt of this letter in order for us to accommodate any necessary revisions before the end of the public comment period or before the public hearing, if one is

-2-

scheduled. If you have any questions concerning the enclosed conditions or the procedures associated with the permit program, please contact us at the above address or by calling (404) 562-XXXX.

Sincerely,

XXXX XXXXX, Chief
Ground Water & UIC Section
Ground Water/Drinking Water Branch

Enclosures

Example of a Permit for a New Well

U. S. ENVIRONMENTAL PROTECTION AGENCY
UNDERGROUND INJECTION CONTROL PERMIT
AUTHORIZATION TO OPERATE A CLASS II INJECTION WELL
EPA UIC PERMIT NUMBER KYI00XX

Pursuant to the Underground Injection Control regulations of the U.S. Environmental Protection Agency codified at Title 40 of the Code of Federal Regulations, Parts 124, 144, 146 and 147,

Wilcox Oil Company
120 Oil Field Road
Columbia, KY 42000

is hereby authorized to construct, operate, and plug and abandon the following Class II enhanced recovery injection well:

William Jones #1
Western Oil Field
Adair County, Kentucky
Carter Coordinate 14-G-50
330' FSL x 330' FWL

This authorization is in accordance with the limitations, monitoring requirements and other conditions set forth herein. This permit consists of this cover sheet; Part I, 7 pages; Part II, 13 pages; and Part III, 1 page.

All references to Title 40 of the Code of Federal Regulations are to regulations that are in effect on the date that this permit becomes effective.

This permit shall become effective on XXXX.

This permit and the authorization to inject shall remain in full force and effect during the operating life of the well, unless this permit is otherwise modified, revoked and reissued, terminated, or a minor modification is made as provided at 40 C.F.R. §§144.39, 144.40 and 144.41. This permit shall be reviewed at least once every five years from the effective date.

Date

XXXXX

Robert F. McGhee, Director
Water Management Division
U.S. Environmental Protection Agency
Region 4

PART I
WELL SPECIFIC CONDITIONS

SECTION A. CONSTRUCTION REQUIREMENTS

1. Casing and Cementing

The permittee shall case and cement the well and maintain all casing and cement so as to prevent the movement of fluids into or between underground sources of drinking water. The casing and cement used in the construction of the well shall be designed for the life expectancy of the well. Construction of this well shall be performed as specified in Attachments L & M of the permit application.

2. Tubing and Packer

Injection may only take place through tubing with a packer set within the casing no higher than 1500 feet below land surface. The tubing and packer shall be maintained in a manner which is compatible with the injection operation specified in Part I, Section B, and which prevents the movement of fluids into or between underground sources of drinking water.

3. Logs, Tests and Reports

The following tests and reports shall be prepared and submitted to EPA to demonstrate mechanical integrity:

- (a) A copy of all logs run in the well.
- (b) Cement tickets and invoice from the contracted cementing service company indicating cement volume, type, additives, and a job description summary.
- (c) A demonstration of the mechanical integrity of the well is required before injection can be authorized. The demonstration will consist of a pressure test on the tubing/casing annulus to at least 300 psig with less than 3% pressure loss in 30 minutes. The permittee shall contact EPA to arrange a date to conduct this test. A representative of EPA will be present to witness this test. If the well fails the test, the permittee shall cease injection operations until the problem is corrected and mechanical integrity can be demonstrated.

- (d) The permittee shall prepare a report, including procedures and results, of the logging and testing programs. Each log shall include a written interpretation prepared by a knowledgeable log analyst. The report must be submitted in accordance with Part I, Section A, item 4, and shall be signed in accordance with Part II, Section E, item 11, of this permit.

4. Commencing Injection

The well authorized by this permit may not commence injection until:

- (a) Construction is complete, and the permittee has submitted to the Director, by certified mail with return receipt requested, a notice of completion using EPA Form 7520-10, and either:
 - (I) The Director has inspected or otherwise reviewed the new injection well and finds it is in compliance with the conditions of the permit; or
 - (ii) The permittee has not received, within thirteen (13) days of the date of the Director's receipt of the notice required above, notice from the Director of his or her intent to inspect or otherwise review the new injection well, in which case prior inspection or review is waived and the permittee may commence injection.
- (b) The permittee has demonstrated to EPA that the injection well has mechanical integrity, and has submitted the reports as specified in Part I, Section A, item 3.
- (c) Corrective action as specified in Part III is completed, and a report, signed in accordance with Part II, Section E, item 11, has been submitted to and approved by the Director.

SECTION B. OPERATING REQUIREMENTS

1. Injection Operation

Beginning on the date that Part I, Section A, item 4, is completed and lasting through the term of this permit, the permittee is authorized to inject only fluids brought to the surface in connection with conventional oil and natural gas

production from the operations in the Western Oil Field for enhanced recovery operations under the following conditions:

(a) Injection Zone

Injection shall be limited to the Knox Formation in the open hole interval between 1550 and 1600 feet below land surface.

(b) Injection Pressure Limitation

- (i) Injection pressure shall not initiate fractures or propagate existing fractures in the injection zone. The maximum allowable wellhead injection pressure for the injection well will initially be established at 900 psig. If the permittee wishes to inject above 900 psig, it shall be proven through the use of a step-rate injectivity test, that such additional pressure will not fracture the injection zone. Upon approval by the Director, the permittee may inject at the maximum pressure attained during any step-rate test conducted on the injection well authorized by this permit provided the test proves such pressure will not fracture or extend fractures in the injection zone. Step-rate injectivity test procedures must be approved by the Director prior to conducting the test and the test may be witnessed by EPA or an agent designated by EPA.
- (ii) Injection at a pressure which initiates or propagates fractures in the confining zone or causes the movement of injection or formation fluids into an underground source of drinking water is prohibited.
- (iii) Injection between the outermost casing protecting underground sources of drinking water and the well bore is prohibited.

2. Annulus Operation

The annulus between the tubing and the long-string casing shall be filled with brine or other fluid as approved by the Director. The annulus pressure shall be maintained at 0 psig.

The annulus shall be monitored with a gauge designed to indicate both a vacuum (below atmospheric) and positive pressure (above atmospheric). The permittee shall comply

with Part I, Section B, item 3, when a change in the annulus pressure of 15 psig occurs. The permittee shall provide an explanation to the Director for the change in pressure and measures that will be taken to restore annulus pressure to achieve compliance with this Section. If the cause of annulus pressure change is not corrected within 48 hours, the permittee shall cease injection unless such order to cease operation is waived by the Director.

3. Loss of Mechanical Integrity During Operation

The permittee shall cease injection if a loss of mechanical integrity as defined at 40 C.F.R. §146.8 becomes evident during operation. Operation shall not be resumed until the permittee has complied with the provisions of Part II, Section G, of this permit regarding mechanical integrity demonstration and testing.

The permittee shall notify the Director of the loss of mechanical integrity in accordance with the reporting procedures in Part II, Section E, item 12(d).

SECTION C. MONITORING REQUIREMENTS

1. Sampling and Analysis Methods

Samples and measurements taken for the purpose of monitoring shall be representative of the monitored activity. Grab samples shall be used for the laboratory analysis of the physical and chemical characteristics as specified in Part I, Section C, item 3(a). Test methods and procedures shall be as specified at 40 C.F.R. §136.3 or 40 C.F.R. Part 261, Appendix III. When the analytical method for a particular parameter is not specified at either 40 C.F.R. §136.3 or 40 C.F.R. Part 261, Appendix III, the permittee must obtain the Director's approval of the method used. The permittee shall identify the types of tests and methods used to generate all monitoring data. Reports to be generated from monitoring data are specified in Part I, Section D.

2. Injection Operation Monitoring

The permittee shall monitor the operation of the injection well as follows:

<u>Parameter</u>	<u>Monitoring Frequency</u>
Injection Pressure (psig) at Wellhead	Weekly
Annulus Pressure (psig) at Wellhead	Weekly
Flow Rate (barrels/day) of Injected Fluid	Weekly
Cumulative Volume (barrels) of Injected Fluid	Weekly

Observation and recording of injection pressure, annulus pressure, flow rate and cumulative volume shall be made over equal time intervals beginning on the date on which the well commences operation. Recordings shall be of representative values.

3. Injection Fluid Analysis

The permittee shall conduct an injection fluid analysis at least once every twelve (12) months and whenever changes are made to the injection fluid. Analyses shall be made beginning within twelve (12) months from the effective date of this permit, or twelve (12) months from the most recent analysis, whichever is later. An analysis must include:

- (a) pH, total dissolved solids, and specific gravity; and
- (b) a list of all chemicals and their composition used for any well stimulation and fracturing during that sampling year; and a list of any additives used and their chemical composition, including any inhibitors used to prevent scaling, corrosion, or bacterial growth. These lists should indicate the brand name of the product and the manufacturer.

On the written request of EPA, an injection fluid analysis shall include the following additional constituents: barium, calcium, total iron, magnesium, sodium, bicarbonate,

carbonate, chloride, sulfate, carbon dioxide, dissolved oxygen, hydrogen sulfide, and purgeable aromatic hydrocarbons.

SECTION D. REPORTING REQUIREMENTS

1. Reports on Well Tests and Workovers

Within ninety (90) days after the completion of the activity, the permittee shall report to the Director the results of the following:

- (a) Mechanical integrity tests, other than those specified in Part I, Section A, item 3; and
- (b) Any well workover, logging or other test data, other than those specified in Part I, Section A, item 3, revealing downhole conditions.

2. Reporting of Monitoring Results

Monitoring results, as specified in Part I, Section C, shall be reported each year on EPA Form 7520-11 and must be postmarked by the 28th day of the month following the first full year after the effective date of this permit.

Copies of the monitoring results required by Part I and all other reports required by Part II shall be submitted to the Director at the following address:

U. S. Environmental Protection Agency
Region 4, Water Management Division
Ground Water/Drinking Water Branch
Ground Water & UIC Section
61 Forsyth Street, SW
Atlanta, Georgia 30303-8909

3. Reporting of New Wells Drilled Within the Area of Review (AOR)

Within ten (10) days after spud date, the permittee shall report to the Director by certified mail, return receipt requested, the construction plans for any new well within the AOR of the permitted facility that will penetrate the confining zone or injection zone. The permittee shall provide information on proposed construction (including location and quantities of cement), location and depth. This requirement applies to any construction activity regardless of ownership of the well.

If the construction of the new well will not protect USDWs from contamination, the Director may terminate the permit under 40 C.F.R. §144.40(a)(3), if he or she determines that continued injection may endanger human health or the environment.

SECTION E. PLUGGING AND ABANDONMENT PLAN

Plugging and abandonment (P&A) of the permitted injection well shall be in accordance with Part II, Section F, of this permit and 40 C.F.R. §146.10.

During the operating life of the permitted well, this injection facility may be screened for technologically enhanced naturally occurring radioactive material (NORM) by EPA or another party. If the permittee is notified by a party other than EPA, or becomes aware at any time that elevated levels of NORM have been detected at this injection facility, the permittee must notify EPA in writing of that fact no later than 45 days prior to the permittee's intent to P&A the well. EPA may require the permittee to revise the P&A plan to insure the safe disposal and proper management of elevated levels of NORM waste.

The plugging of this injection well shall be performed in the manner described in Attachment Q of the permit application.

PART III

SPECIAL CONDITIONS

CORRECTIVE ACTION AND/OR WELL DATA

1. There is no documentation for the cementing of one well within the area of review (AOR) of the William Jones #1 well. Consequently, that well here identified as the William Jones #3 will require the following:
 - (a) The permittee shall submit cement documentation for this well indicating a sufficient volume to yield a top of cement (TOC) within the confining zone overlying the Knox Formation, or
 - (b) The permittee shall submit a cement bond log (CBL) indicating that this well is cemented within the confining zone.
 - (c) In the absence of a sufficient volume of cement as indicated by (a) or (b) above, the permittee shall submit a plan for performing remedial cementing on this well or submit a plan for plugging this well. On approval by the director, the permittee shall conduct remedial cementing or plugging according to the approved plan.
2. Cement documentation for the William Jones #7 well yields a calculated TOC below the Knox formation. Therefore, this well will require the following:
 - (a) The permittee shall submit a cement bond log (CBL) indicating that this well is cemented within the confining zone.
 - (b) In the absence of a sufficient volume of cement as indicated by (a) above, the permittee shall submit a plan for performing remedial cementing on this well or submit a plan for plugging the well. On approval by the Director, the permittee shall conduct remedial cementing or plugging according to the approved plan.

Example of a Public Notice to Issue a Permit

PUBLIC NOTICE

U. S. Environmental Protection Agency

Region 4

Water Management Division - Ground Water/Drinking Water Branch

61 Forsyth Street, SW

Atlanta, Georgia 30303-8909

(404) 562-9424

Public Notice No. KY98UIC00XX

April 3, 1998

NOTICE OF PROPOSED ISSUANCE OF
UNDERGROUND INJECTION CONTROL PERMIT

The U. S. Environmental Protection Agency (EPA), Region 4, intends to issue an Underground Injection Control (UIC) permit under the authority of the Federal Regulations at 40 C.F.R. Parts 124, 144, 146, and 147 to

Wilcox Oil Company
120 Oil Field Road
Columbia, KY 42000

UIC Permit Application Number KYI00XXX

The proposed Class 2 permit will authorize the construction, operation, and plugging and abandonment of the William Jones #1 enhanced recovery well in the Western Oil Field located in Adair County, Kentucky, Carter Coordinate 14-G-50, 330' FSL x 330' FWL.

The permitted well will be used to inject produced brine brought to the surface in connection with conventional oil and natural gas production from the operations in the Western Oil Field for enhanced recovery into the Knox Formation in the open hole interval from 1550 to 1600 feet below the surface.

The proposed UIC permit was drafted in accordance with the provisions of the Safe Drinking Water Act, as amended (42 U.S.C. 300f et seq., commonly known as SDWA) and other lawful standards and regulations. The permit limitations and conditions are tentative and open to comment from the public. Persons wishing to comment upon or object to any aspects of the permit issuance are invited to submit same in writing within thirty (30) days of this notice to the U. S. Environmental Protection Agency, Water Management Division, Ground Water/Drinking Water Branch, Ground Water & UIC Section, 61 Forsyth Street, S.W., Atlanta, Georgia 30303-8909, ATTENTION: XXXXX XXXXX. The public notice number and the UIC permit number should be included in the first page of comments. All comments received during the public notice

period will be made a part of the administrative record of this permit and will be available for public review.

All comments received within the thirty-day period will be considered in the formulation of the final determination regarding the permit issuance. Any interested person may, within the thirty-day period, request a public hearing, as provided by 40 C.F.R. §124.12. Where there is a significant degree of public interest in the proposed permit issuance, the EPA Regional Administrator will hold a public hearing. Any request for a hearing must be in writing to the address given above and must state the nature of the issues proposed to be raised in the hearing.

After consideration of all timely written comments, the requirements and policies in the Safe Drinking Water Act and appropriate regulations, and, if a hearing is held, after consideration of all comments, statements and data presented at the hearing, the EPA Regional Administrator or his designee will make final determinations regarding the permit issuance. If the final determinations are substantially unchanged from the tentative determinations outlined above, the EPA Regional Administrator or his designee will so notify all persons who submitted written comments or participated in the hearing, if any was held. If the final determinations are substantially changed, the EPA Regional Administrator or his designee will issue a public notice indicating the revised determinations.

Within thirty (30) days after the Regional Administrator serves notice of the above final permit decision, any person who filed comments or participated in the public hearing, if any, may petition the Administrator to review the permit decision or any condition therein. Any person who failed to file comments or failed to participate in the public hearing, if any, may petition for administrative review only to the extent of the changes from the draft to the final permit decision. Additional information regarding administrative review is available in 40 C.F.R. §124.19 or by contacting the Legal Support Branch of the Environmental Accountability Division at the above address or at telephone number (404) 562-9488. A petition to the Administrator under 40 C.F.R. §124.19 is a prerequisite to the seeking of judicial review of the final permit decision.

The administrative record, including application, statement of basis, draft permit, comments received, and additional information on hearing procedures is available by writing to EPA at the above address, or for review and copying at 61 Forsyth Street, 9th Floor, Atlanta, Georgia, 30303-8909, between the hours of 8:15 a.m. and 4:30 p.m., Monday through Friday. Copies will be provided at a cost of 20 cents per page.

Please bring the foregoing to the attention of anyone who may be interested in this matter.

Example of a Statement of Basis

UNITED STATES ENVIRONMENTAL PROTECTION AGENCY

REGION 4

Statement of Basis

for

U. S. EPA Underground Injection Control (UIC) Draft Permit Number
KYI00XX

for

Wilcox Oil Company
120 Oil Field Road
Columbia, KY 42000

for

The construction, operation, and plugging and abandonment of
the William Jones #1 located in:

Western Oil Field
Adair County, KY
Carter Coordinate 14-G-50
330' FSL x 330' FWL

On March 16, 1998, Wilcox Oil Company submitted a UIC permit application and requested a permit for the construction, operation, and plugging and abandonment of the above mentioned well. This application and its subsequent amendments have been reviewed by EPA Region 4 staff and were deemed complete on April 14, 1998.

Under the authority of 40 C.F.R. Parts 144 and 146, EPA permits must specify conditions for construction, operation, monitoring, reporting, and plugging and abandonment of injection wells so as to prevent the movement of fluids into any underground source of drinking water (USDW). General provisions for EPA UIC permit requirements are found at 40 C.F.R. Parts 144 and 146, while regulations specific to Kentucky injection operations are found at 40 C.F.R. Part 147, Subpart S. In addition, permit conditions specific to this well are as follows.

Area of Review (AOR) and Corrective Action: In accordance with 40 C.F.R. §§144.55, 146.6 and 146.7, this is the area surrounding the well or project which the applicant must research, examine

and develop a program to address, with a corrective action plan, wells which penetrate the injection zones that are improperly sealed, completed or abandoned and may therefore provide a conduit for fluid migration. Except for the William Jones #3 and the William Jones #7, the applicant has provided documentation on the well population within one-quarter mile of the injection well (i.e., AOR) indicating that all the wells are properly constructed and corrective action will not be required.

Underground Sources of Drinking Water: USDWs are defined by the UIC regulations as aquifers or portions thereof which contain less than 10,000 parts per million of total dissolved solids and which are being or could be used as a source of drinking water. The lowermost possible USDW has been identified at approximately 150 feet below ground surface. The geologic name of this fresh water bearing formation is the Ft. Payne Formation.

Injection and Confining Zones: Injection of fluids for enhanced recovery is limited by the permit to the Knox Formation in the open hole interval between 1550 and 1600 feet below ground surface. This injection zone is separated from the lowermost USDW by a confining zone comprised of Devonian Age shale, Silurian Age limestones and Ordovician Age limestones with a thickness of approximately 1400 feet.

Construction Requirements: The construction of the injection well meets the regulatory criteria of 40 C.F.R. §146.22 which requires that all new Class II wells be sited so that they inject into a formation which is separated from any USDW by a confining zone free of known open faults or fractures within the AOR; and that all Class II wells be cased and cemented to prevent the movement of fluids into or between USDWs.

Injection Fluid: The injected fluid is limited to fluids brought to the surface in connection with conventional oil and natural gas production from the operations in the Western Oil Field. The expected maximum daily volume of fluid to be injected is 200 barrels.

Maximum Injection Pressure: The maximum allowable wellhead injection pressure for the proposed operation will be 900 psig. This limitation will ensure that the pressure during injection does not initiate new fractures or propagate existing fractures in the confining zones adjacent to the lowermost USDW. This in turn ensures that the injection pressure will not cause the movement of injection or formation fluids into a USDW, as required at 40 C.F.R. §146.23.

Monitoring and Reporting Requirements: In accordance with 40 C.F.R. §§144.54 and 146.23, the applicant will be responsible for monitoring injection pressure, annulus pressure, flow rate, and

cumulative volume on a weekly basis and reporting monitoring results to EPA on an annual basis. The applicant is also required to conduct and pass a two-part mechanical integrity test (MIT), in accordance with 40 C.F.R. §146.8, once after the well is complete and once every five years thereafter. These tests will provide EPA with an evaluation of the integrity of the tubular goods (casing, tubing, and packer) as well as documentation as to the absence of fluid movement behind the cemented casing.

Plugging and Abandonment: In accordance with 40 C.F.R. §§146.10 and 146.24(d), the permit includes a plugging and abandonment plan that will result in environmentally protective well closure at the time of cessation of operations. The applicant has also made a demonstration of financial responsibility, in accordance with 40 C.F.R. §§144.52(a) and 146.24(a), which indicates that adequate resources will be available for well closure and will preclude the possibility of abandonment without proper plugging.

Expiration Date: In accordance with 40 C.F.R. §144.36, the permit will be in effect for the life of the well or project, unless it is otherwise modified, revoked and reissued, or terminated as provided at 40 C.F.R. §§144.39, 144.40 and 144.41. The permit will be reviewed by EPA at least once every five (5) years from the effective date for consistency with federal regulations.

Additional Information: Questions, comments and requests for additional information or for a public hearing may be directed to the contact person listed below. The public comment period on this permitting action will close thirty (30) days after the date of the public notice. If EPA receives written comments of substantial public interest concerning a hearing on this action, a public notice of this hearing will be published locally and mailed to interested parties.

XXXX XXXX
U. S. EPA, Region 4
Water Management Division
Ground Water/Drinking Water Branch
Ground Water & UIC Section
61 Forsyth Street, SW
Atlanta, Georgia 30303-8909

