

**Final**  
**Total Maximum Daily Load for Fecal Coliform**  
**Six Stream Segments within the Beargrass Creek Watershed**  
**Jefferson County, Kentucky**  
**December, 2011**



**Photo of Beargrass Creek (Tetra Tech)**

**List of Contributors**

Dr. Lindell Ormsbee, UK  
Ben Albritton, Scientist I, UK  
Elizabeth Coyle, Research Assistant, UK  
Dr. Chandramouli Viswanathan, Research Scientist  
Dr. Jon Butcher, Tetra Tech





**Commonwealth of Kentucky  
Steven L. Beshear, Governor**

**Energy and Environment Cabinet  
Len Peters, Secretary**

The Energy and Environment Cabinet (EEC) does not discriminate on the basis of race, color, national origin, sex, age, religion, or disability. The EEC will provide, on request, reasonable accommodations including auxiliary aids and services necessary to afford an individual with a disability an equal opportunity to participate in all services, programs and activities. To request materials in an alternative format, contact the Kentucky Division of Water, 200 Fair Oaks Lane, Frankfort, KY 40601 or call (502) 564-3410. Hearing- and speech-impaired persons can contact the agency by using the Kentucky Relay Service, a toll-free telecommunications device for the deaf (TDD). For voice to TDD, call 800-648-6057. For TDD to voice, call 800-648-6056.


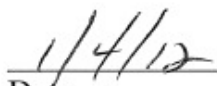
Printed on recycled/ recyclable paper with state (or federal) funds.



**Final**  
**Total Maximum Daily Load for Fecal Coliform**  
**Six Stream Segments within the Beargrass Creek Watershed**  
**Jefferson County, Kentucky**  
**December, 2011**

**Kentucky Department for Environmental Protection**  
**Division of Water**

This report is approved for release:

  
\_\_\_\_\_  
Sandra L. Gruzesky, Director  
Division of Water  
  
  
\_\_\_\_\_  
Date



## ACKNOWLEDGMENTS

The development of this TMDL involved a joint partnership between the Kentucky Water Resources Research Institute (KWRRRI) and the Louisville Metropolitan Sewer District (MSD) along with its primary consultants: Strand, Inc., Tetra Tech Inc., and O'Brien and Gere. Many of the maps in the report were generated using data obtained from the Louisville/Jefferson County Information Consortium (LOJIC) through its participating partner, the Louisville Metropolitan Sewer District (MSD). The Kentucky Division of Water, TMDL Section, was also actively involved in providing technical and regulatory guidance during the process.

This report, and in particular the technical appendices, draws heavily on work by Tetra Tech, Inc., and O'Brien and Gere as published in the report: "Beargrass Creek Water Quality Tool Model Calibration and Validation Report" (2007). Subsequent computer simulations in support of the TMDL calculations were also provided by Tetra Tech in response to specific requests by the KWRRRI. The KWRRRI assumed the responsibility of a Quality Assurance/Quality Control (QA/QC) officer during the entire project period (2003-2008) and was ultimately responsible for assembling the various components of the final TMDL.

## TABLE OF CONTENTS

<b>LIST OF ACRONYMS .....</b>	<b>VIII</b>
<b>LIST OF FIGURES.....</b>	<b>X</b>
<b>LIST OF TABLES .....</b>	<b>XI</b>
<b>TMDL SYNOPSIS.....</b>	<b>XIII</b>
<b>1.0 INTRODUCTION AND WATERBODY IDENTIFICATION.....</b>	<b>1</b>
1.1 WATERBODY NAME AND LOCATION .....	1
1.2 WATERBODY ID .....	1
1.3 LOCATION OF WATERSHED .....	2
1.4 ELEVATION AND TOPOGRAPHY OF WATERSHED .....	2
1.5 A NOTE ON TOPOGRAPHIC DATA .....	2
1.6 GEOLOGIC INFORMATION .....	4
1.7 SOILS INFORMATION .....	7
1.8 LAND USE INFORMATION .....	9
1.9 HYDROLOGIC INFORMATION .....	11
1.10 WATERSHED AND SEWER SYSTEM HISTORY .....	13
1.11 SEWER SYSTEM .....	17
1.11.1 Trunk System.....	17
1.11.2 Sanitary Sewer Overflows .....	18
1.11.3 Combined Sewer Overflows .....	20
1.12 STORMWATER MANAGEMENT SYSTEM .....	22
1.13 WATERBODY 303(d) LIST STATUS .....	25
1.14 KPDES PERMITTED DISCHARGES .....	27
<b>2.0 MONITORING.....</b>	<b>28</b>
2.1 RAIN GAGE NETWORK .....	28
2.2 STREAMFLOW NETWORK.....	31
2.3 CONTINUOUS WATER QUALITY MONITORING .....	33
2.4 DISCRETE WATER QUALITY SAMPLING .....	35
2.5 CSO AND SSO FLOW MONITORING .....	37
2.6 MONITORING RESULTS .....	37
<b>3.0 PROBLEM DEFINITION.....</b>	<b>38</b>
3.1 IMPAIRMENTS .....	38
3.2 CAUSES.....	38
3.3 TARGET IDENTIFICATION.....	40
3.4 WATER QUALITY ASSESSMENT .....	41
<b>4.0 SOURCE ASSESSMENT .....</b>	<b>42</b>
4.1 ASSESSMENT OF POINT SOURCES .....	42
4.2 CSO FLOW CONTRIBUTION .....	47
4.3 ASSESSMENT OF NONPOINT SOURCES.....	48
4.4 GROUNDWATER CONTRIBUTIONS .....	49
<b>5.0 MODELING PROCEDURE: LINKING THE SOURCES TO THE ENDPOINT .....</b>	<b>50</b>
5.1 MARGIN OF SAFETY.....	50
5.2 MODELING FRAMEWORK SELECTION .....	50

5.3	MODEL SELECTION .....	51
5.4	MODEL CALIBRATION .....	52
5.5	CRITICAL PERIOD .....	57
5.6	MODEL APPLICATION .....	59
5.7	MODEL RESULTS .....	60
<b>6.0</b>	<b>TMDL, LOAD ALLOCATION, AND LOAD REDUCTIONS .....</b>	<b>61</b>
6.1	LOAD REDUCTION STRATEGIES .....	61
6.2	ADDITIONAL REDUCTIONS .....	64
6.3	TMDL AND ALLOCATIONS .....	68
<b>7.0</b>	<b>IMPLEMENTATION .....</b>	<b>78</b>
7.1	THE GOAL OF THE TMDL .....	78
7.2	POTENTIAL STRATEGIES .....	78
7.3	REGULATORY PROGRAMS .....	78
7.4	OTHER PROGRAMS .....	81
7.5	NON-GOVERNMENTAL ORGANIZATIONS .....	82
7.6	MODIFICATIONS .....	83
<b>8.0</b>	<b>PUBLIC PARTICIPATION .....</b>	<b>84</b>
<b>9.0</b>	<b>REFERENCES .....</b>	<b>85</b>
<b>APPENDIX A: FECAL COLIFORM OBSERVATIONS</b>		<b>A-1</b>
<b>APPENDIX B: DESCRIPTION OF THE WATER QUALITY TOOL</b>		<b>B-1</b>
<b>APPENDIX C: HYDROLOGIC CALIBRATION/VALIDATION OF THE WQT</b>		<b>C-1</b>
<b>APPENDIX D: WATER QUALITY CALIBRATION OF THE WQT</b>		<b>D-1</b>
<b>APPENDIX E: EXCURSION FREQUENCIES BASELINE SCENARIOS</b>		<b>E-1</b>
<b>APPENDIX F: EXCURSION FREQUENCIES NO CSO/SSO</b>		<b>F-1</b>
<b>APPENDIX G: EXCURSION FREQUENCIES CSO STORAGE/TREATMENT</b>		<b>G-1</b>
<b>APPENDIX H: EXCURSION FREQUENCIES SEPARATE SEWER SCENARIO</b>		<b>H-1</b>

## LIST OF ACRONYMS

BGC	Beargrass Creek
BMP	Best Management Practices
CSA	Combined Sewer Area
CSO	Combined Sewer Overflow
CSS	Combined Sewer System
CWA	Clean Water Act
DEP	Department of Environmental Protection
DMR	Discharge Monitoring Report
DO	Dissolved Oxygen
EPA	U.S. Environmental Protection Agency
GIS	Geographical Information Systems
GM	Geometric Mean
GNIS	Geographic Names Information System
HRU	Hydrologic Response Unit
HSG	Hydrologic Soil Groups
HSPF	Hydrologic Simulation Program Fortran
HUC	Hydrologic Unit Code
I/I	Infiltration and Inflow
KAR	Kentucky Administrative Regulations
KDOW	Kentucky Division of Water
KPDES	Kentucky Pollution Discharge Elimination System
KWA	Kentucky Waterways Alliance
KWRRI	Kentucky Water Resources Research Institute
LA	Load Allocations
LOJIC	Louisville/Jefferson County Information Consortium
LTMN	Long Term Monitoring Network
MOS	Margin of Safety
MS4	Municipal Separate Storm Sewer Systems

---

MSD	Louisville and Jefferson County Metropolitan Sewer District
MSL	Mean Sea Level
NADP	National Atmospheric Deposition Program
NSQD	National Stormwater Quality Database
NPDES	National Pollution Discharge Elimination System
NPS	Nonpoint Source
QAPP	Quality Assurance Project Plan
QA/QC	Quality Assurance/Quality Control
RIV-1	CE-QUAL-RIV1 water quality model
RTC	Real Time Control
SSA	Sanitary Sewer Area
SSES	Sanitary Sewer Evaluation Studies
SSO	Sanitary Sewer Overflow
SSS	Sanitary Sewer System
SWMM	Stormwater Management Model
SWMP	Stormwater Management Plan
TMDL	Total Maximum Daily Load
UK	University of Kentucky
USEPA	United States Environmental Protection Agency
USGS	United States Geological Survey
WASP	Water Quality Analysis Simulation Program
WLA	Wasteload Allocation
WQM	Water Quality Management
WQS	Water Quality Standard
WQT	Water Quality Tool
7Q10	Seven-day, consecutive low flow with a ten year return frequency



## LIST OF FIGURES

Figure S.1 Location of Beargrass Creek Watershed.....	xx
Figure S.2 Impaired Stream Segments and Stream Miles in the Beargrass Creek Watershed....	xxi
Figure S.3 Sub-basins and Monitoring Stations .....	xxii
Figure S.4 KPDES Permitted Fecal coliform Contributors .....	xxiii
Figure 1.1 Location of Beargrass Creek Watershed (Developed using data from LOJIC, 2007) ..	2
Figure 1.2 Digital Elevation Model for the Beargrass Creek Watershed .....	3
Figure 1.3 Geologic Map of the Beargrass Creek Watershed .....	5
Figure 1.4 Generalized Hydrogeologic Sensitivity and Karst Development.....	6
Figure 1.5 Soils by Hydrologic Soil Group in the Beargrass Creek Watershed.....	8
Figure 1.6 Beargrass Creek Watershed Land Use Distribution.....	10
Figure 1.7 Sub-basin Delineation of the Beargrass Creek Watershed.....	12
Figure 1.8 MSD's Earliest Underground Sewers .....	13
Figure 1.9 Package Sewage Treatment Plan.....	15
Figure 1.10 Force Main Crossing Beargrass Creek .....	16
Figure 1.11 Locations of CSOs, Documented SSOs and Major Trunk Sewers .....	19
Figure 1.12 Enlargement of CSO Area with CSO Discharge Locations .....	22
in the Southern Portions of South Fork and Middle Fork.....	22
Figure 1.13 Stormwater Detention Facilities within Beargrass Creek Watershed .....	24
Figure 1.14 Impaired Steam Segments and Stream Miles in the Beargrass Creek.....	26
Figure 1.15 KPDES Permitted Fecal coliform Contributors .....	27
Figure 2.1 Rain Gage Network in and around Beargrass Creek Watershed.....	30
Figure 2.2 USGS Stream Gage Locations (Tetra Tech, et al., 2007) .....	32
Figure 2.3 Continuous Water Quality Monitoring Sites in Beargrass Creek Watershed .....	34
Figure 2.4 Discrete Water Quality Sampling Locations .....	36
Figure 3.1 Impaired Stream Segments and Stream Miles in the Beargrass Creek Watershed .....	39
Figure 4.1 Locations of CSOs, Documented SSOs and Land Use Distribution.....	43
Figure 4.2 KPDES Permitted Fecal coliform Contributors .....	46
Figure 4.3 CSO and Non-CSO Contributions to Flow at Confluence of South and Middle Fork during Large Runoff Event of March 4-5, 2001 .....	48
Figure 4.4 CSO and Non-CSO Contributions to Flow at Confluence of South and Middle Fork during Moderate Runoff Events of April 1 and April 3, 2001.....	48
Figure 5.1 Sub-basin Grouping for Reporting Purposes.....	58

## LIST OF TABLES

Table S.1 Summary of Cumulative Annual Loadings (cfu) .....	xiv
Table S.2 Summary of Loading Reductions to Achieve the TMDL .....	xvi
Table S.3 Annual Cumulative Allocations to Achieve the TMDL.....	xvii
Table S.4 Average Daily and 95% Percentile Allocations to Achieve the TMDL by Stream Segment.....	xviii
Table S.5 TMDL (Wasteload Allocations) Associated with KPDES Sites.....	xix
Table 1.1 Beargrass Creek Sub-watershed 14 Digit HUC Codes.....	1
Table 1.2 Geologic Formations in the Beargrass Creek Watershed .....	5
Table 1.3 Hydrologic Soil Groups by Percent Area for the Beargrass Sub-watersheds.....	7
Table 1.4 Beargrass Creek Sub-watershed Land Use Types by Area (square miles).....	11
Table 1.5 Numbers of CSOs and Documented SSOs* by Sub-basin .....	21
Table 1.6 CSO Year Built by Sub-Basin .....	21
Table 1.7 Aggregate Summary of Wastewater and Stormwater Statistics by Sub-basin .....	23
Table 1.8 Beargrass Ck.Impacted Streams/Suspected Pollutant Sources (KDOW, 2008).....	25
Table 1.9 KPDES Permits.....	27
Table 2.1 Long-term Meteorology and Precipitation Data in Beargrass Creek Watershed .....	29
Table 2.2 Interim Precipitation Gages in Beargrass Creek Watershed.....	29
Table 2.3 Precipitation Gages to Support Radar System in Beargrass Creek Watershed .....	29
Table 2.4 Stream Gaging Stations in the Beargrass Creek Watershed .....	31
Table 4.1 Inventory of Permitted CSOs in the Beargrass Creek Watershed .....	44
Table 4.2 TMDL (Wasteload Allocations) Associated with KPDES Sites .....	45
Table 4.3 CSO Contribution to Total Flow, South and Middle Forks of Beargrass Creek .....	47
Table 5.1 Relationship between Computational and Reporting Sub-basins.....	52
Table 5.2 Summary of Average Annual Loadings (cfu) per Sub-basin and Source Category .....	53
Table 5.3 Summary of Average Annual Loadings (cfu) per Stream Segment and Source Category .....	54
Table 5.4 Relative Errors and Statistical Targets for Hydrologic Calibration.....	55
Table 5.5 Calibration and Validation Statistics for Fecal Coliform Bacteria (cfu/100 mL).....	56
Table 5.6 Prediction Statistics for Fecal Coliform Bacteria (cfu/100 mL) at Higher Flows .....	56
Table 5.7 Prediction Statistics for Fecal Coliform Excursions.....	56
Table 5.8 Frequency of Water Quality Excursions (Failures) for Baseline (Existing) Conditions .....	60
Table 5.9 Frequency of Water Quality Excursions (Failures) for Baseline..... with all SSOs and CSOs Eliminated.....	60 60
Table 6.1 Summary of Initial Loading Reductions for Scenario I: CSO Storage/Treatment per Subbasin and Source Category .....	62
Table 6.2 Summary of Initial Loading Reductions for Scenario I: CSO Storage/Treatment per Stream Segment and Source Category.....	62
Table 6.3 Summary of Initial Loading Reductions for Scenario II: Sewer Separation per Subbasin and Source Category .....	63
Table 6.4 Summary of Initial Loading Reductions for Scenario II: Sewer Separation per Stream Segment and Source Category .....	63
Table 6.5 Frequency of Water Quality Excursions for Scenario I.....	64
Table 6.6 Frequency of Water Quality Excursions for Scenario II .....	64

Table 6.7 Summary of Final Loading Reductions for Scenario I: CSO Storage/Treatment per Subbasin and Source Category .....	66
Table 6.8 Summary of Final Loading Reductions for Scenario I: CSO Storage/Treatment per Stream Segment and Source Category.....	66
Table 6.9 Summary of Final Loading Reductions for Scenario II: Sewer Separation per Subbasin and Source Category .....	67
Table 6.10 Summary of Final Loading Reductions for Scenario II: Sewer Separation per Stream Segment and Source Category .....	67
Table 6.11 Final Frequency of Water Quality Excursions for Scenario I .....	68
Table 6.12 Final Frequency of Water Quality Excursions for Scenario II.....	68
Table 6.13 Average Annual Allocations to Achieve the TMDL (Scenario I with Additional Reductions) by Subbasin and Source Category .....	69
Table 6.14 Average Annual Allocations to Achieve the TMDL (Scenario I with Additional Reductions) by Stream Segment and Source Category .....	70
Table 6.15 Average Daily and 95% Percentile Loadings to Achieve TMDL (Scenario I with Additional Reductions) by Subwatershed and Source Category .....	70
Table 6.16 Average Daily and 95% Percentile Loadings to Achieve TMDL (Scenario I with Additional Reductions) by Subbasin and Source Category .....	71
Table 6.17 Average Daily and 95% Percentile Loadings to Achieve the TMDL (Scenario I with Additional Reductions) by Stream Segment and Source Category .....	72
Table 6.18 Annual Allocations to Achieve the TMDL (Scenario II with Additional Reductions) per Subbasin and Source Category .....	73
Table 6.19 Average Annual Allocations to Achieve the TMDL (Scenario II with Additional Reductions) per Stream Segment and Source Category .....	74
Table 6.20 Average Daily and 95% Percentile Loadings to Achieve the TMDL (Scenario II with Additional Reductions) by Subwatershed and Source Category .....	74
Table 6.21 Average Daily and 95% Percentile Loadings to Achieve the TMDL (Scenario II with Additional Reductions) by Subbasin and Source Category .....	75
Table 6.22 Average Daily and 95% Percentile Loadings to Achieve the TMDL (Scenario II with Additional Reductions) by Stream Segment and Source Category .....	76
Table 6.23 TMDL (Wasteload Allocations) Associated with KPDES Sites .....	77

## TMDL SYNOPSIS

### Key Features

<b>Project Name:</b>	Beargrass Creek watershed fecal coliform TMDLs
<b>Location:</b>	Jefferson County, KY
<b>Scope/Size:</b>	Beargrass Creek watershed, approximately 60 mi <sup>2</sup>
<b>Major Tributaries:</b>	Middle Fork, Muddy Fork, and South Fork Beargrass Creek
<b>303(d)-Listed Segments:</b>	South Fork, RM 0.0-2.7 and 2.7-13.6, Middle Fork, RM 0.0-2.0, 2.0-2.9, and 2.9-15.3 and Muddy Fork, RM 0.0-6.9
<b>Pollutant(s):</b>	Fecal coliform, an indicator for the presence of pathogenic organisms
<b>Causes:</b>	Municipal point sources, Urban runoff/storm sewers, Land disposal, Combined sewer overflows, Sanitary sewer overflows
<b>Land Use Type:</b>	Urban
<b>TMDL Issues:</b>	Point and nonpoint
<b>Data Sources:</b>	USGS stream flow monitoring, MSD and NEXRAD rainfall data, MSD continuous water quality monitoring data, MSD water quality sampling data, MSD collection system flow monitoring data, LOJIC GIS data, UK Department of Civil Engineering data
<b>Control Measures:</b>	KPDES permits, 319 Watershed Based Plans Kentucky Watershed Framework Initiative, Federal Consent Decree

### Summary:

The Kentucky 2010 303(d) Report identifies 35.8 miles of stream segments in the Beargrass Creek watershed (see Figures S.1 and S.2) as not supporting the designated use of primary contact recreation (swimming) due to fecal coliform impairment (Kentucky Division of Water [KDOW], 2008). These include 13.6, 15.3 and 6.9 mile segments of the South Fork, Middle Fork and Muddy Fork of Beargrass Creek, respectively. Although the main stem of Beargrass Creek (i.e. the 1.8 mile segment downstream of the confluence with Muddy Fork) was not listed for fecal coliforms in the 2010 303(d) report, compliance of this segment with the associated water quality standards was verified as part of the overall TMDL analysis.

A comprehensive Water Quality Tool (WQT) that links together several sophisticated computer models was used in developing total maximum daily fecal coliform loads for Beargrass Creek (Tetra Tech, et. al., 2007). For the purposes of representing Beargrass Creek, the watershed (and

its associated sub-watersheds – i.e. Muddy Fork, Middle Fork, and South Fork) was subdivided into 31 sub-basins as shown in Figure S.3. The computer generated simulated flows and fecal loadings for each of these sub-basins (taking into consideration both point and nonpoint loadings) which were then simulated as being transported down through the channel and sewer systems associated with each of the sub-basins until the flows and loads were simulated exiting Beargrass Creek. Numerical results from these 31 sub-basins were aggregated into 11 larger reporting sub-basins (Figure S.3) whose outlets corresponded to existing water quality monitoring stations, or the physical outlet of a particular sub-watershed (i.e. Muddy Fork, Middle Fork, South Fork, and Beargrass Creek). Results were then translated to the individual stream segments as shown in Figure S.2.

**Table S.1 Summary of Cumulative Annual Loadings (cfu) per River Mile and Source Category**

SUB-WATERSHED/ River Mile	SUB-BASIN	Existing Loadings (cfu/yr) Total	Existing Wasteload (cfu/yr) SSO Sources	Existing Wasteload (cfu/yr) CSO Sources	Existing Wasteload (cfu/yr) MS4 Sources	Existing Wasteload (cfu/yr) KPDES Sources	Existing Wasteload and Load (cfu/yr) Groundwater Sources
<b>BEARGRASS CREEK WATERSHED</b>							
River Mile 0.5-1.8	SMS000	2.14E+16	4.96E+09	8.24E+15	1.31E+16	1.27E+13	8.95E+13
<b>MUDDY FORK BEARGRASS CREEK</b>							
River Mile 0.0-6.9	SMU000	1.99E+15	1.05E+07	0.00E+00	1.99E+15	2.76E+09	2.16E+12
<b>MIDDLE FORK BEARGRASS CREEK</b>							
River Mile 0.0-2.0	SMI000	6.60E+15	1.51E+09	1.04E+15	5.52E+15	0.00E+00	3.89E+13
River Mile 2.0-2.9	SMI004	6.04E+15	1.51E+09	6.74E+14	5.34E+15	0.00E+00	3.15E+13
River Mile 2.9-15.3	SMI002	5.39E+15	1.51E+09	4.65E+14	4.91E+15	0.00E+00	2.18E+13
<b>SOUTH FORK BEARGRASS CREEK</b>							
River Mile 0.0-2.7	SSF000	1.19E+16	3.38E+09	6.40E+15	5.48E+15	1.27E+13	3.87E+13
River Mile 2.7-13.6	SSF001	8.37E+15	1.66E+09	2.95E+15	5.39E+15	1.27E+13	1.59E+13

An application of the WQT to Beargrass Creek has revealed that the existing system will not satisfy the Kentucky primary recreational water quality standards, even with the removal of all the sanitary sewer overflows (SSOs) and combined sewer overflows (CSOs). As a consequence, some type of additional load reduction strategy is necessary. Once the WQT model for Beargrass Creek was calibrated and validated, the associated point and nonpoint loads for each sub-basin were reduced until the in-stream water quality criteria were satisfied. The final loads, resulting in compliance with the water quality standard (inclusive of the margin of safety), constitute the TMDL for each sub-basin.

Two different water quality conditions were evaluated for system compliance: 1) a chronic condition in which the 30 day geometric mean of predicted values (i.e. 200 cfu/100 ml for May through October and 1000 cfu/100 ml for November through April) were satisfied 90% of the time and 2) an acute condition in which the maximum observed values (i.e. less than 400 cfu/100 ml during May through October and less than 2000 cfu/100 ml for November through April) were satisfied for 80% of the time.

Two different potential management scenarios were investigated for possible use in meeting the water quality criteria and establishing the TMDL: 1) CSO storage/treatment along with associated nonpoint source (NPS) and groundwater reductions (including complete elimination of all SSOs), and 2) Sewer separation along with associated NPS and groundwater reductions (including complete elimination of all SSOs). Multiple computer analyses were performed for each scenario before a final set of reductions was found that satisfied the criteria discussed previously. It should be emphasized that although the two scenarios show examples of how the water quality standard might be obtained, additional means to accomplish this may be determined and selected in the future.

For each scenario, a 95% reduction in the NPS fecal coliform load was initially assumed. Groundwater load reductions ranged from 40% in Muddy Fork to 97.6% in the lower reach of Beargrass Creek. For load reduction scenario I, all CSO discharge volumes were assumed to be reduced by 50% with the associated concentration of the remaining discharge reduced by 95%. For load reduction scenario II, all CSO discharges were assumed to be eliminated. Excess stormwater that was originally diverted to the CSOs was now assumed to discharge directly to the stream. The loads associated with these discharges were also assigned a reduction of 95%, consistent with the other NPS load reductions.

Both scenarios resulted in fecal coliform exceedance thresholds lower than a 20% level for maximum criteria (i.e. 9.6% to 17.5%) and lower than a 10% level for geometric mean criteria (i.e. 0% to 8.80%). In fact, scenario II results in exceedance thresholds of 11.4% for the maximum criteria and 1.9% for the geometric mean criteria. It should be recognized, however, that sewer separation is normally a costly enterprise, especially in highly urbanized areas and will likely not eliminate the need for additional treatment or reduction of any residual NPS. As a consequence, because scenario I may provide a more cost effective management scenario while still providing for an adequate margin of safety (MOS); this scenario was used as the basis of determining the TMDLs for each of the sub-watersheds.

Subsequent to the initial completion of the TMDL, regulators from Region 4 of USEPA ruled that the chronic criteria should be satisfied with a compliance percentage of 100% as opposed to the 90% criteria that had been specified by Kentucky Division of Water and that was the basis of the load reductions associated with the computer analyses associated with this TMDL. In response, additional adjustments to the loads were made to raise the chronic compliance rate from 90% to 100%. This was achieved by imposing additional load reductions on the groundwater loading component. A summary of the final load reductions to satisfy the associated TMDLs for this scenario is provided in Table S.2.

Once the TMDL for the watershed has been determined, the associated load must be allocated between KPDES-permitted loads (i.e. wasteload allocations) including both the Kentucky Pollution Discharge Elimination System (KPDES) point source and municipal separate storm sewer systems (MS4) nonpoint source and non KPDES-permitted nonpoint source loads (i.e. load allocations). The difference between the initial existing load and the associated TMDL allocations provides the amount of required load reduction. The groundwater source is hypothesized as being associated with leaking sewers and surface water sources that have migrated into the groundwater. Since the leaking sewer source is ultimately related to permitted sources (through a KPDES permit), part of the groundwater load has been treated as an illegal

wasteload and its WLA set at zero. The remaining groundwater source has been designated as a non-KPDES-permitted nonpoint source and its allowable load is specified under the load allocation. Further research may need to be conducted to determine the precise distribution of sources as related to the groundwater contribution.

**Table S.2 Summary of Loading Reductions to Achieve the TMDL**

SUB-WATERSHED	STATISTIC	Average Annual Reduction	WASTELOAD REDUCTION SSO Sources	WASTELOAD REDUCTION CSO Sources	WASTELOAD REDUCTION MS4 Sources	WASTELOAD REDUCTION KPDES Sources	WASTELOAD and LOAD REDUCTION Groundwater Sources
<b>BEARGRASS CREEK MAINSTEM</b>							
River Mile 0.5 - 1.8	Maximum	96%	100%	98%	95%	0%	88%
<b>MUDDY FORK BEARGRASS CREEK</b>							
River Mile 0.0 – 6.9	Maximum	95%	100%	NA	95%	0%	46%
<b>MIDDLE FORK BEARGRASS CREEK</b>							
River Mile 0.0-15.3 (entire impaired reach)	Maximum	95%	100%	98%	95%	0%	91%
River Mile 0.0 - 2.0	Maximum	95%	100%	98%	95%	0%	91%
River Mile 2.0 – 2.9	Maximum	95%	100%	98%	95%	0%	90%
River Mile 2.9 – 15.3	Maximum	95%	100%	98%	95%	0%	88%
<b>SOUTH FORK BEARGRASS CREEK</b>							
River Mile 0.0 –13.6 (entire impaired reach)	Maximum	96%	100%	98%	95%	0%	86%
River Mile 0.0 – 2.7	Maximum	96%	100%	98%	95%	0%	86%
River Mile 2.7 – 13.6	Maximum	97%	100%	98%	95%	0%	69%

Summarizing the TMDL and associated allocations presents some challenges, because different types of sources are present on different days and the relevant water quality standards allow a certain percentage of excursions. The allocations are most clearly summarized in terms of annual loads; however, recent court rulings require that all TMDLs and associated allocations contain an explicit daily component. Therefore, the allocations are first expressed on an annual average basis. The daily component is then expressed consistent with USEPA (2007) guidance through specification of a daily average and a daily “maximum” value, which provide a basis for evaluation of future monitoring data. The daily average is simply the average annual load from the TMDL scenario divided by 365.25 days (which combines days with and without wet weather flows), while the maximum value is expressed as the 95<sup>th</sup> percentile of daily values from the continuous simulation. Use of the 95<sup>th</sup> percentile, rather than the absolute maximum, helps protect against the possible presence of anomalous outliers in the model simulation and adds an additional Margin of Safety to the TMDL. In determining the final TMDL value, an implicit margin of safety of approximately 10% was used by requiring that the water quality standards

were met with a greater frequency than required. A summary of the TMDL and the associated load allocations for each stream mile and stream segment are provided in Tables S.3 – S.4

The Morris Forman Wastewater Treatment Plant does not discharge directly to Beargrass Creek; however, 57 combined sewer overflows are permitted under this facility (permit # KY0022411). For the purpose of this study, the aggregate loads associated with these sources are summarized in the Existing Wasteload (CSO sources) column in Table S.1 and the Wasteload Allocations (CSO sources) columns in Tables S.2-S.3. In addition, the Louisville MS4 area is permitted under KPDES number KYS000001 and the Kentucky Transportation Cabinet MS4 under permit number KYS000003. For the purpose of this study, the aggregate loads associated with these sources are summarized in the Existing Wasteload (MS4 sources) column in Table S.1 and the Wasteload Allocations (MS4 sources) columns in Tables S.2-S.3.

**Table S.3 Annual Cumulative Allocations to Achieve the TMDL**

SUB-WATERSHED/ River Mile	STATISTIC	Average Annual Loadings (cfu/yr)	Wasteload Allocation (cfu/yr) SSO Sources	Wasteload Allocation (cfu/yr) CSO Sources	Wasteload Allocation (cfu/yr) MS4 Sources	Wasteload Allocation (cfu/yr) KPDES Sources	Load Allocation (cfu/yr) Groundwater Nonpoint Sources
<b>BEARGRASS CREEK WATERSHED</b>							
River Mile 0.5-1.8	Total	8.70E+14	0.00E+00	2.05E+14	6.41E+14	1.27E+13	1.03E+13
<b>MUDDY FORK BEARGRASS CREEK</b>							
River Mile 0.0-6.9	Total	1.01E+14	0.00E+00	0.00E+00	9.95E+13	2.76E+09	1.17E+12
<b>MIDDLE FORK BEARGRASS CREEK</b>							
River Mile 0.0-2.0	Total	3.05E+14	0.00E+00	2.60E+13	2.76E+14	0.00E+00	3.46E+12
River Mile 2.0-2.9	Total	2.87E+14	0.00E+00	1.68E+13	2.67E+14	0.00E+00	3.15E+12
River Mile 2.9-15.3	Total	2.60E+14	0.00E+00	9.00E+12	2.54E+14	0.00E+00	2.72E+12
<b>SOUTH FORK BEARGRASS CREEK</b>							
River Mile 0.0-2.7	Total	4.40E+14	0.00E+00	1.60E+14	2.61E+14	1.27E+13	5.50E+12
River Mile 2.7-13.6	Total	3.49E+14	0.00E+00	7.39E+13	2.57E+14	1.27E+13	4.90E+12



**Table S.4 Average Daily and 95% Percentile Allocations to Achieve the TMDL by Stream Segment**

SUB-WATERSHED/ River Mile	STATISTIC	Average Annual Loadings (cfu/day)	Wasteload Allocation (cfu/day) SSO Sources	Wasteload Allocation (cfu/day) CSO Sources	Wasteload Allocation (cfu/day) MS4 Sources	Wasteload Allocation (cfu/day) KPDES Sources	Load Allocation (cfu/day) Groundwater Nonpoint Sources
<b>BEARGRASS CREEK WATERSHED</b>							
River Mile 0.5 - 1.8	Average	6.58E+10	0.00E+00	5.46E+10	1.06E+10	0.00E+00	6.01E+08
	95%	4.11E+11	0.00E+00	3.32E+11	7.52E+10	0.00E+00	4.23E+09
<b>MUDDY FORK BEARGRASS CREEK</b>							
River Mile 0.0 – 6.9	Average	2.76E+11	0.00E+00	0.00E+00	2.72E+11	7.57E+06	3.20E+09
	95%	1.91E+12	0.00E+00	0.00E+00	1.90E+12	7.57E+06	1.37E+10
<b>MIDDLE FORK BEARGRASS CREEK</b>							
River Mile 0.0- 15.3 (entire impaired reach)	Average	8.36E+11	0.00E+00	7.12E+10	7.55E+11	0.00E+00	9.47E+09
	95%	6.01E+12	0.00E+00	4.66E+11	5.48E+12	0.00E+00	6.27E+10
River Mile 0.0 - 2.0	Average	5.08E+10	0.00E+00	2.51E+10	2.48E+10	0.00E+00	8.45E+08
	95%	3.27E+11	0.00E+00	1.61E+11	1.59E+11	0.00E+00	5.91E+09
River Mile 2.0 - 2.9	Average	7.46E+10	0.00E+00	1.43E+10	5.91E+10	0.00E+00	1.19E+09
	95%	5.32E+11	0.00E+00	9.37E+10	4.29E+11	0.00E+00	9.24E+09
River Mile 2.9 – 15.3	Average	7.11E+11	0.00E+00	3.18E+10	6.72E+11	0.00E+00	7.44E+09
	95%	5.13E+12	0.00E+00	2.08E+11	4.87E+12	0.00E+00	4.79E+10
<b>SOUTH FORK BEARGRASS CREEK</b>							
River Mile 0.0- 13.6 (entire impaired reach)	Average	1.20E+12	0.00E+00	4.38E+11	7.16E+11	3.48E+10	1.51E+10
	95%	8.07E+12	0.00E+00	2.68E+12	5.30E+12	3.48E+10	6.39E+10
River Mile 0.0 - 2.7	Average	2.50E+11	0.00E+00	2.36E+11	1.21E+10	0.00E+00	1.73E+09
	95%	1.54E+12	0.00E+00	1.44E+12	8.58E+10	0.00E+00	7.29E+09
River Mile 2.7 – 13.6	Average	9.55E+11	0.00E+00	2.02E+11	7.04E+11	3.48E+10	1.34E+10
	95%	6.54E+12	0.00E+00	1.24E+12	5.21E+12	3.48E+10	5.67E+10

In addition to these KPDES permits, the watershed also contains four additional KPDES permits as summarized in Table S.5 and shown in Figure S.4. In the absence of extensive data sets for these sites, an assumption was made that each of these sites is operating at its permitted wasteload (i.e. permitted discharge\*200 cfu/100 ml). Thus, the associated TMDL for each of these point sources is simply equal to this corresponding wasteload (see Table S.5). As a result, no wasteload reduction is required. The existing wasteloads and the wasteload allocations for all MS4 sources (i.e. Tables S.1 – S.4) thus reflect the total wasteload in each subbasin and stream reach, minus any wasteload associated with any of the any permitted point sources (i.e. Table S.5) that happen to discharge to that associated subbasin or stream reach.

**Table S.5 TMDL (Wasteload Allocations) Associated with KPDES Sites**

KPDES Permit	Description	Subwatershed	River Mile	Permitted Discharge (MGD)	TMDL (cfu/day)
KY0057061	Louisville Zoo: Outfall 001 Outfall 002	300	South Fork 2.7-13.6	4.6	1.27E+13
KYG400146	Residence	940	Muddy Fork	0.0005	1.38E+09
KYG400206	Residence	910	Muddy Fork	0.0005	1.38E+09
KYG400349	Residence	400	South Fork 2.7-13.6	0.0005	1.38E+09

Note: Any expanding or future KPDES-permitted point source must meet permit limits based on the Water Quality Standards in 401 KAR 10:031.

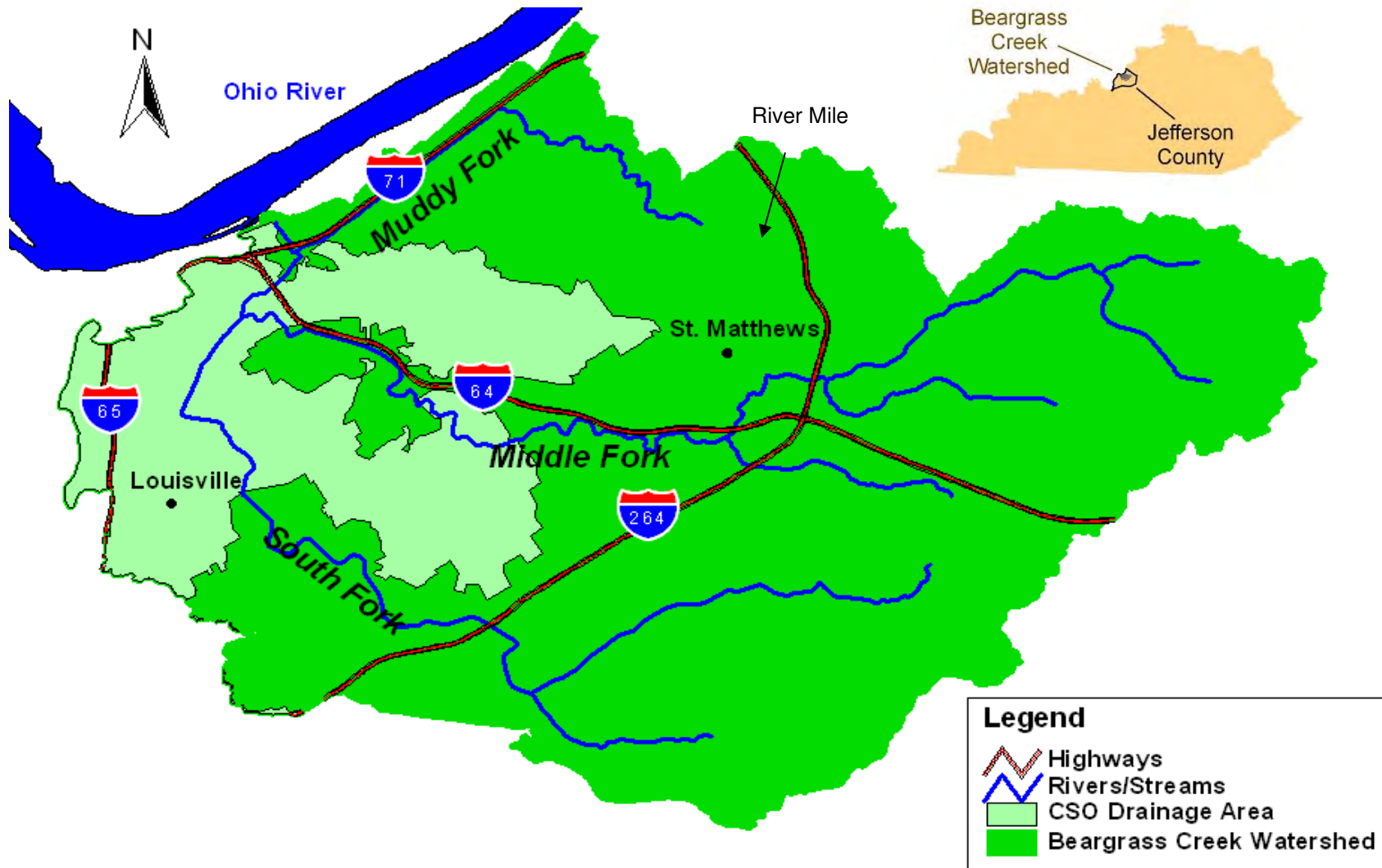


Figure S.1 Location of Beargrass Creek Watershed (Developed using data from LOJIC, 2007)

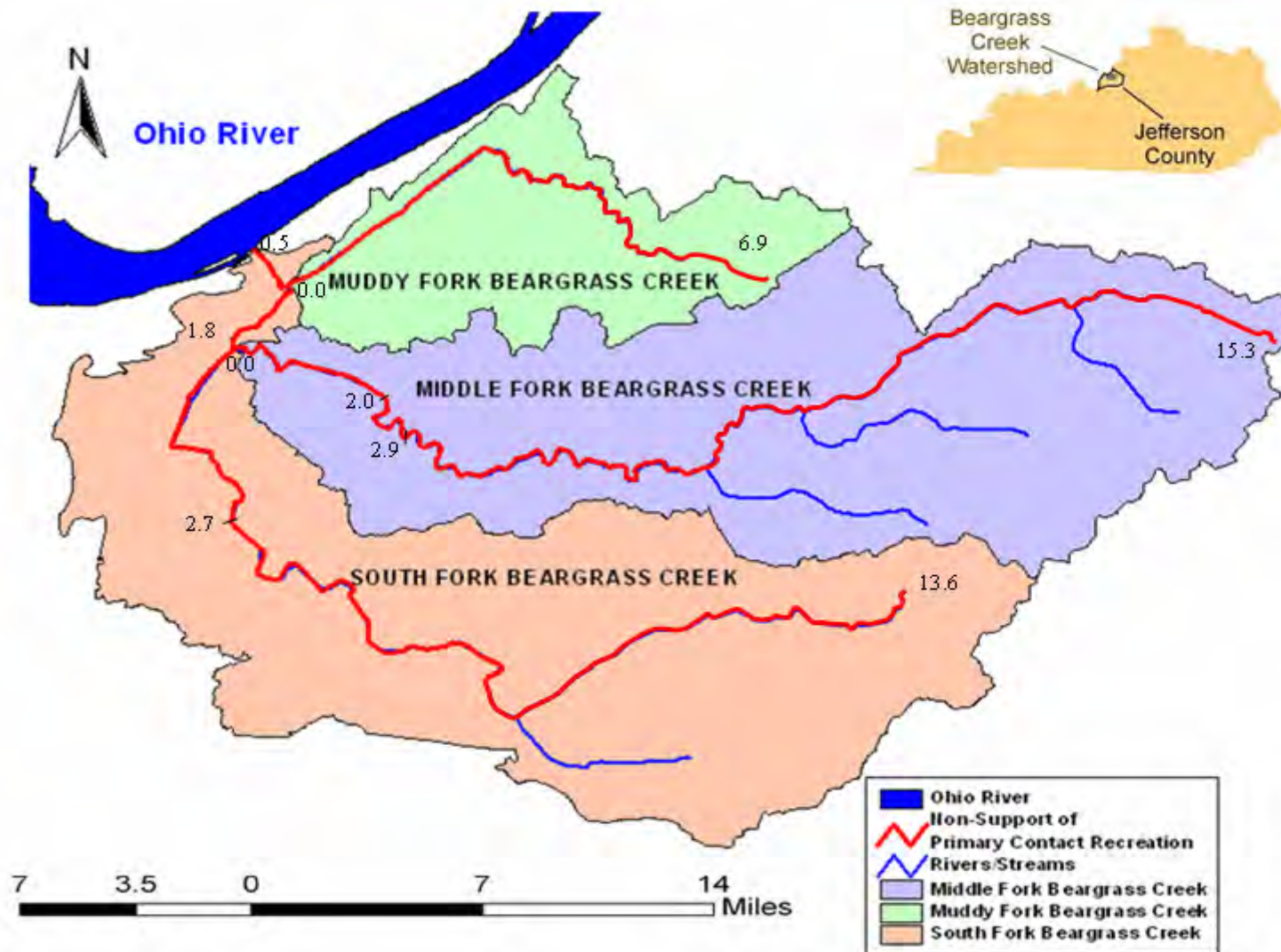


Figure S.2 Impaired Stream Segments and Stream Miles in the Beargrass Creek Watershed (Developed using data from KDOW, 2008; and base map from LOJIC, 2007)

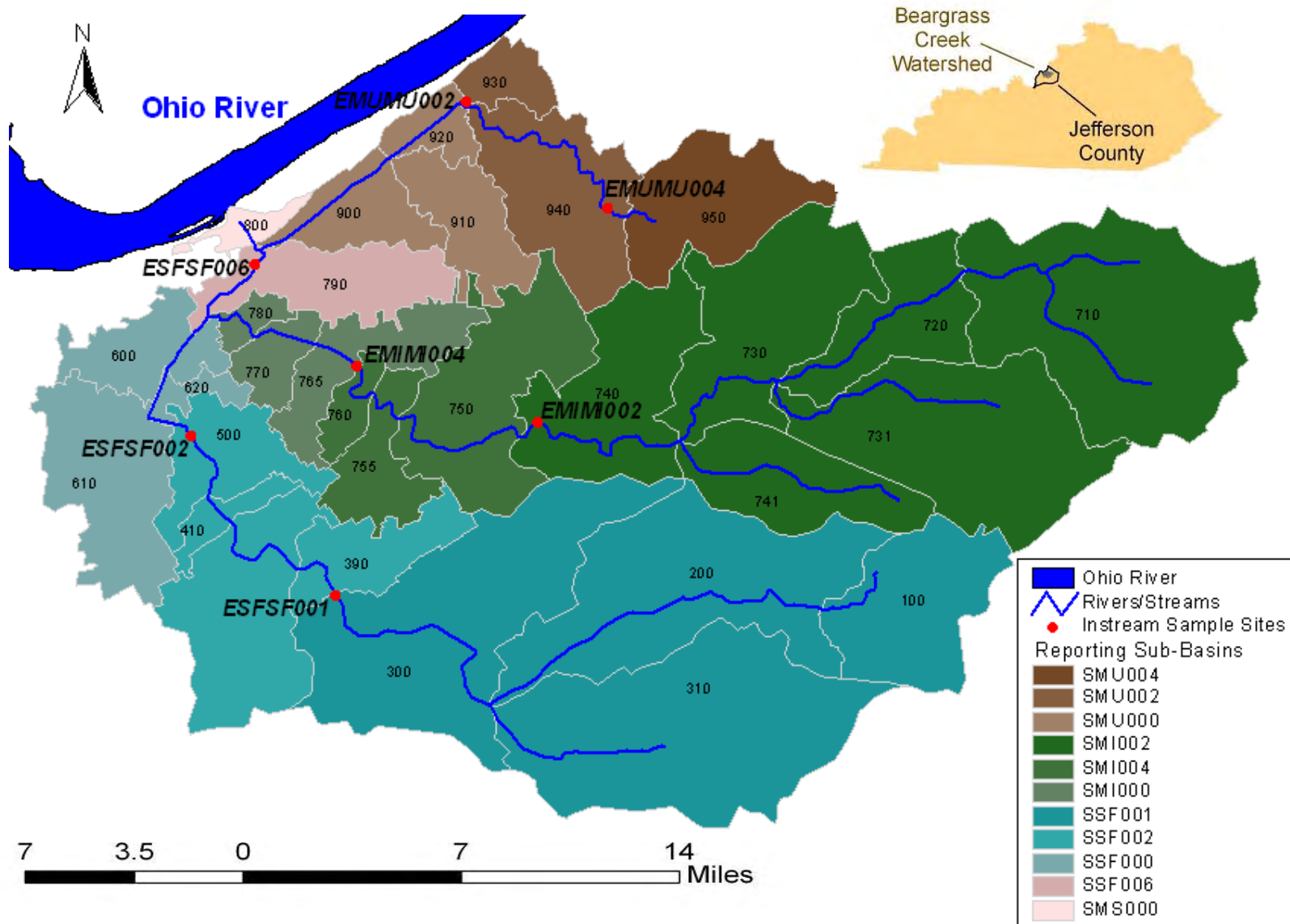


Figure S.3 Sub-basins and Monitoring Stations (Developed using data from Tetra Tech et. al., 2007)

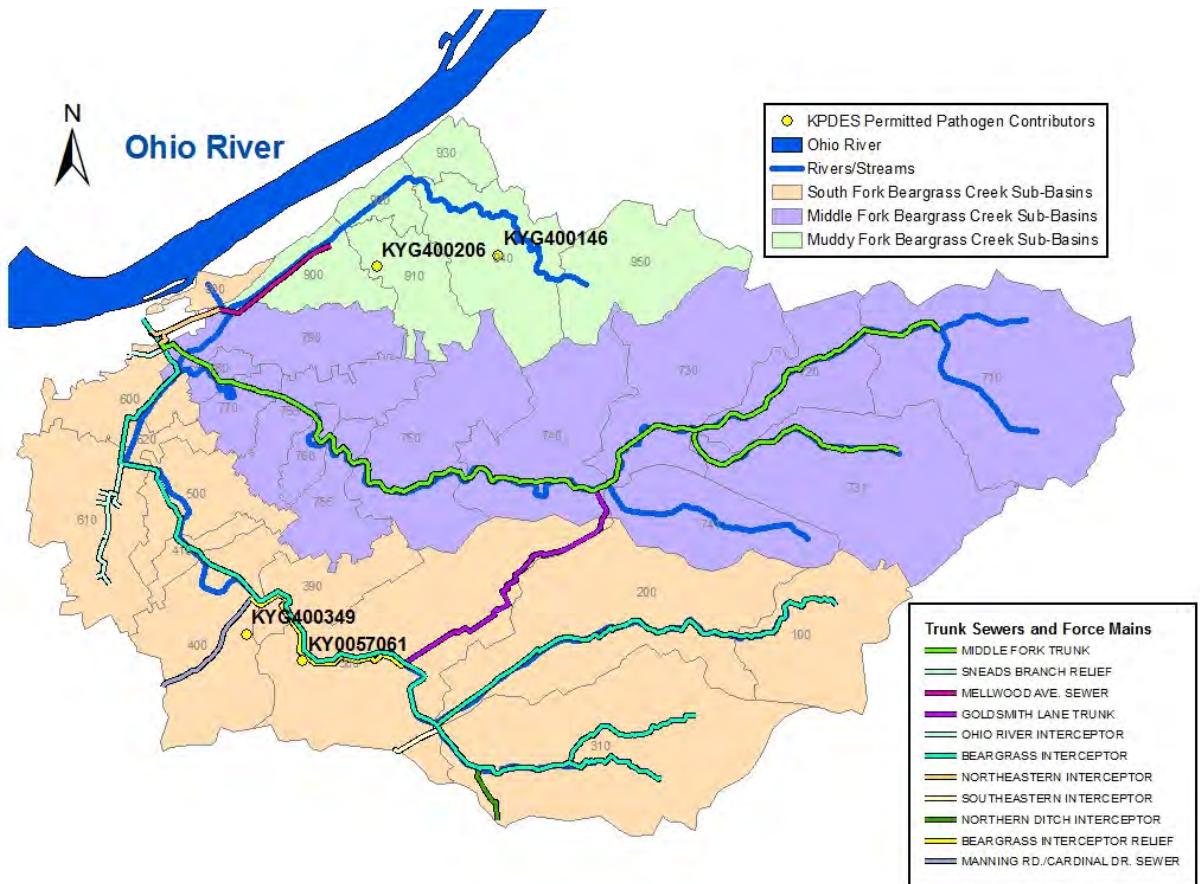


Figure S.4 KPDES Permitted Fecal coliform Contributors

**The Goal of the TMDL**

The goal of the TMDL is to identify potential load and wasteload reductions that could be potentially used to satisfy the water quality standards for Beargrass Creek. The TMDL report is a planning document and is not a regulatory or enforcement document. However, the TMDL, where applicable, may be used in support of regulatory decisions via general or specific discharge permits or through the specific provisions of a consent decree as per Sections 303(d)(2) and 303(e) of the Clean Water Act. In addition, the TMDL may be used to help guide the activities of non-regulatory programs. As with many TMDLs, it should be emphasized that the specific load and wasteload reductions scenarios considered by this TMDL may or may not be economically feasible or physically achievable with existing technologies or currently available best management practices. As a consequence, additional analyses may be required (e.g. through a Long Term Control Plan) in order to identify or refine such solutions. At a minimum, however, the TMDL does identify and quantify relative sources of impairment along with theoretical load or wasteload reductions that would be necessary to achieve water quality standards, and as such, provides a starting point for any future investigations or associated load or wasteload reduction projects.

**Modifications**

In the future, KDOW may adjust the individual wasteload allocations (WLA) in this TMDL to account for new information or circumstances that develop or come to light during the implementation of the TMDL and a review of the new information or circumstances indicate that such adjustments are appropriate. New information generated during TMDL implementation may include, among other things, monitoring data, best management practices (BMPs) effectiveness information and land use information. KDOW will propose adjustments only in the event that any adjusted individual WLA will not result in a change to the total WLA. The adjusted WLA will be set at a level necessary to implement the applicable water quality standard (WQS). KDOW will notify EPA of any adjustments to this TMDL within 30 days of their adoption.

## 1.0 INTRODUCTION AND WATERBODY IDENTIFICATION

Section 303(d) of the Clean Water Act (CWA) and the United States Environmental Protection Agency's (USEPA's) Water Quality Planning and Management Regulations (40 C.F.R. Section 130) require that States develop Total Maximum Daily Loads (TMDLs) for their water bodies that are not meeting designated uses under technology-based controls for pollution. TMDL is a term used to describe the maximum amount of a pollutant a stream can assimilate without violating water quality standards. The units of load measurement are typically mass of pollutant per unit time (e.g., mg/hr, lbs/day). In the case of fecal coliforms, which are typically expressed in terms of number of organisms (or colony forming units) per unit volume (i.e. cfu/100 ml), the load is typically expressed in terms of colony forming units/day.

The TMDL process establishes the allowable loadings of pollutants or other quantifiable parameters for a waterbody based on the relationship between pollution sources and in-stream water quality conditions. This method exists so that states can establish water quality-based controls to reduce pollution from both point and nonpoint sources and restore and maintain the quality of their water resources (USEPA, 1991). This report provides the fecal coliform TMDL for the Beargrass Creek watershed.

### 1.1 Waterbody Name and Location

The City of Louisville, Kentucky is located in Jefferson County in north-central Kentucky. Beargrass Creek lies completely within the Jefferson County boundaries, with its three branches generally flowing from South-East to North-West, through downtown Louisville to the Ohio River. Three major highways intersect in the City of Louisville, I-64, I-65 and I-71 with two interstate bypasses, I-264 and I-265. Beargrass Creek consists of the main branch and three forks, Muddy Fork, Middle Fork and South Fork of Beargrass Creek which are 6.9, 15.8 and 13.6 miles long, respectively (Figure 1.1).

### 1.2 Waterbody ID

The Beargrass Creek watershed lies in the Interior Plateau Ecoregion. The 11 digit hydrologic unit code (HUC) for the entire Beargrass Creek Watershed is 05140101250, encompassing an area of approximately 60 square miles. The HUC codes have been expanded to 14 digits delineating the sub-watersheds as well. Table 1.1 identifies the 14 digit HUC codes for each of the three sub-watersheds in Beargrass Creek as well as the main stem which is broken down into two individual watersheds.

**Table 1.1 Beargrass Creek Sub-watershed 14 Digit HUC Codes**

<b>Subwatershed</b>	<b>14-Digit HUC Code</b>	<b>Area (Sq. Miles)</b>
Beargrass Creek	05140101250030	1.470
Beargrass Creek	05140101250050	0.183
Muddy Fork	05140101250040	7.565
Middle Fork Beargrass Creek	05140101250010	25.233
South Fork Beargrass Creek	05140101250020	26.124



According to the United States Geological Survey (USGS) website for Geographic Names Information System (GNIS), Beargrass Creek has been assigned an identification number of 486584 (2007, <http://geonames.usgs.gov>). In addition, Middle Fork is identified by GNIS number 498112, South Fork by 503905, and Muddy Fork by 499042.

### **1.3 Location of Watershed**

The watershed encompassing Beargrass Creek also lies completely within the Jefferson County boundaries and includes a large portion of downtown Louisville. In addition, 60 other small municipalities lie within or on the boundaries of the Beargrass Creek watershed. This highly urbanized watershed is comprised of three sub-watersheds, the South, Middle and Muddy Fork watersheds of Beargrass Creek and has an area of approximately 60 square miles. The three sub-watersheds; Muddy Fork, Middle Fork and South Fork are 7.6, 25.2 and 26.1 square miles respectively. The Beargrass Creek watershed is included in the Salt/Licking River Basin Watershed Management Unit.

### **1.4 Elevation and Topography of Watershed**

Elevations in the watershed range from 232 meters above mean sea level (MSL) in the eastern headwaters to 128 m above MSL near the Ohio River. Using a 10-m digital elevation model obtained from the USGS, Tetra Tech generated a 10-m map of the watershed as shown in Figure 1.2.

### **1.5 A Note on Topographic Data**

Two different sources of topographic data were used in constructing maps for this report. The first source was the LOJIC (2007) database, which was used to display various physical features of the watershed (e.g. Figure 1.1). This base map is also used in all related MSD publications (2005). As part of their contract, Tetra Tech et al., (2007) developed a more detailed watershed map for the purpose of facilitating the watershed modeling. An example of this base map is shown in Figure 1.2. This map was developed to represent actual drainage areas and is slightly different than Figure 1.1. While figures using the LOJIC base map were used to display general watershed features (e.g. elevation, soil type, etc.), the revised Tetra Tech base map and associated subbasins (e.g. Figure 1.7) were actually used in the modeling effort. Official watershed boundaries may not be accurate in well-developed karst regions. Although groundwater drainage generally follows topographic basin boundaries, this is not always true.

Subsurface drainage transfer between surface watersheds in karst does occur, which increases or decreases the actual area of an affected stream basin. The Kentucky Division of Water and the Kentucky Geological Survey maintain a Karst Atlas of groundwater tracing data and delineated basins (as both static PDF maps and ArcView shape files) that can be downloaded at <http://kygeonet.ky.go> (Kentucky Geography Network, 2008). For example, a 1.17 km<sup>2</sup> area that extends beyond the northern most boundary of the Middle Fork subwatershed actually drains into the Middle Fork subwatershed due to karst features. Due to the dynamic nature of the connecting karst pathway, this small area was not included in the overall modeling effort.

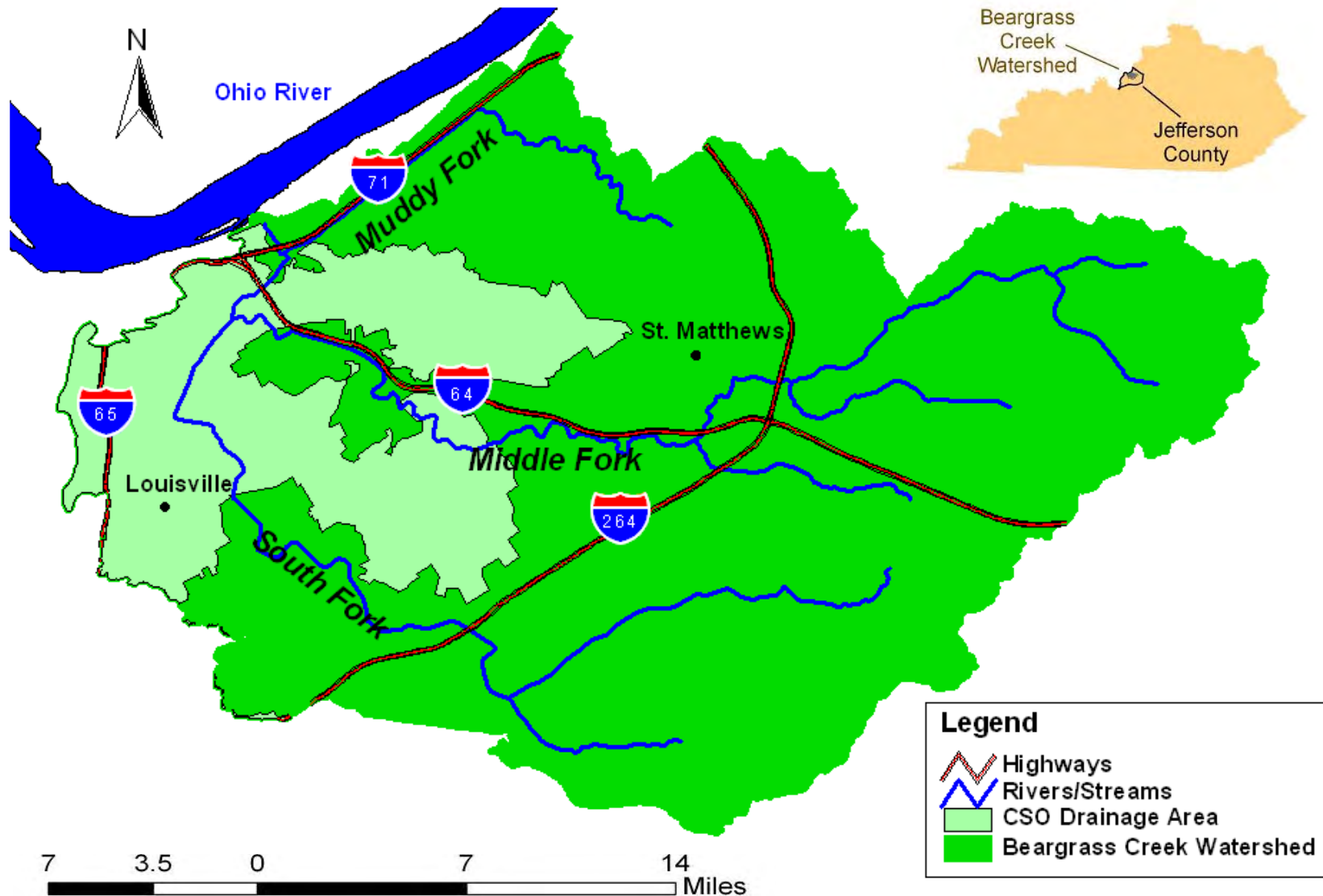


Figure 1.1 Location of Beargrass Creek Watershed (Developed using data from LOJIC, 2007)

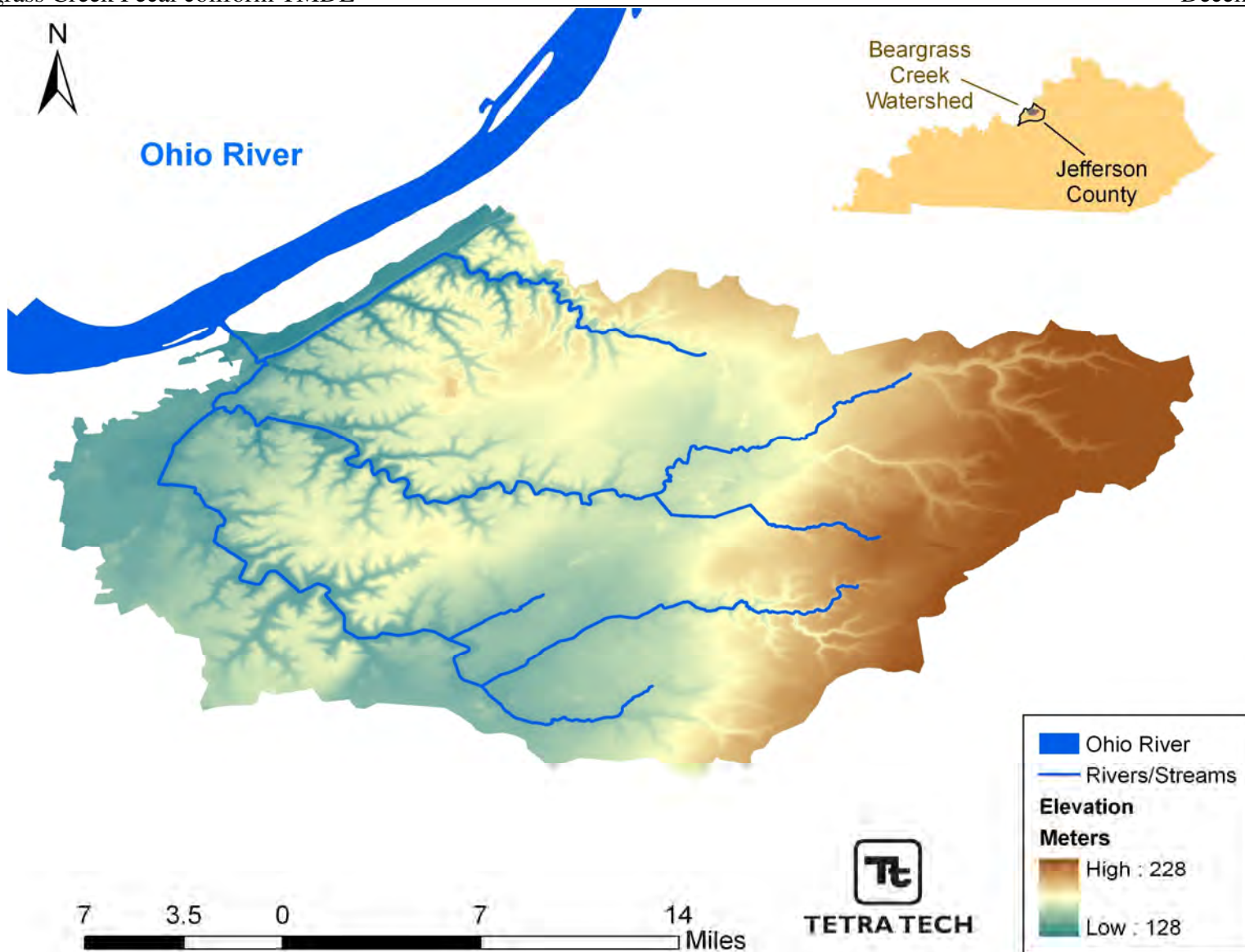


Figure 1.2 Digital Elevation Model for the Beargrass Creek Watershed (Tetra Tech, et al., 2007)

## 1.6 Geologic Information

The Beargrass Creek watershed is in the Outer Bluegrass Physiographic Region of Kentucky. Rock units in the Outer Bluegrass region are generally thin-bedded limestones, dolostones and shales (McDowell, 2001). Although most of the Outer Bluegrass is characterized as having low- to moderately-developed karst, the geologic formations underlying Beargrass Creek watershed exhibit well-developed karst. In particular, the watershed is underlain by the Sellersburg, Jeffersonville and Louisville limestones, with minor amounts of New Albany Shale and Quaternary deposits.

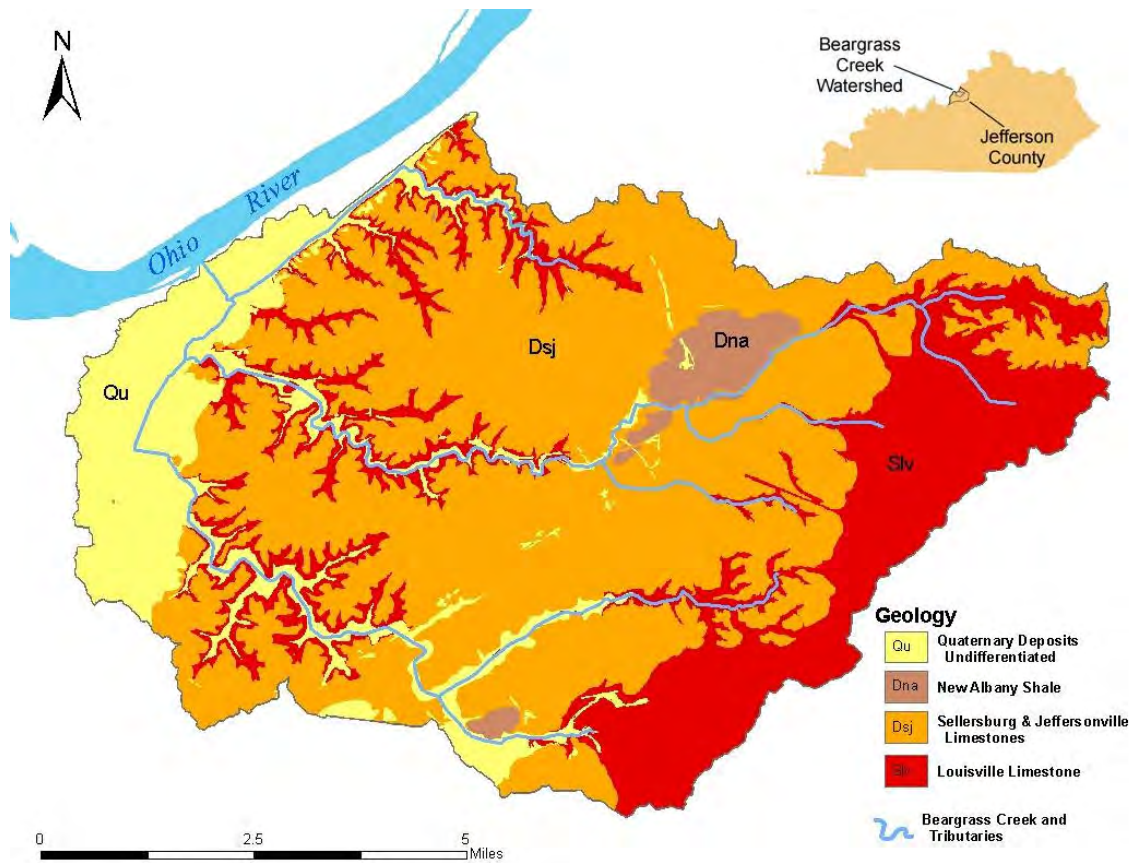
The Quaternary deposits are derived from a variety of sources. Kepferle (1974) notes terrace deposits, loess, glacial outwash, lacustrine deposits and alluvium. However, for the purposes of this report these will be considered holistically as undifferentiated Quaternary deposits (this includes minor amounts of artificial fill). Kepferle (1974) describes the New Albany Shale as silty and carbonaceous, appearing massive in fresh exposures but weathering to thin, brittle chips. Shale is typically thought to inhibit groundwater movement, and therefore, karst development. However, in the Beargrass Creek watershed the New Albany Shale is rather thin, limited in geographic extent, displays sinkhole formation and has active karst conduit flow beneath it (Ray et. al., 2008).

The three limestone units referenced above are the focus for karst development in the Beargrass Creek watershed. The Sellersburg Limestone is partly dolomitic, very fine grained and occurs in thin beds. The Jeffersonville Limestone is also partly dolomitic, but is coarse grained and thinly crossbedded. The Louisville Limestone is dolomitic, very fine grained and occurs as thin to thick beds (Kepferle, 1974). Geologic formations in the Beargrass Creek watershed are summarized in Table 1.2 and illustrated in Figure 1.3 (Kepferle, 1974; Nelson, 2002a-e and Ray et. al., 1994). Evidence of significant karst development includes large cover-collapse sinkholes and documented groundwater velocities in excess of 1.4 km/day (Ray et. al., 2008). Numerous tracer tests from sinkholes and stream swallets within the watershed provide further evidence of karst conduit flow.

These groundwater recharge, or insurgence, features typically do not adequately attenuate or filter contaminants entering the karst drainage network. Potential impacts to water quality in karst regions can take various forms. Thrailkill and others (1982) note that due to the dendritic pattern of karst drainage systems, NPS contaminants can be introduced across a large area and coalesce to be discharged at a single spring. Thus, NPS pollution can be concentrated at one spring which may have significant impacts to the water quality of the receiving stream. Conversely, well-developed karst drainage may also have a radial discharge pattern from topographic highs, allowing contaminants from a single source to be dispersed over a large area (Joseph A. Ray, oral comm. 2008).

**Table 1.2 Geologic Formations in the Beargrass Creek Watershed**

Geologic Formation	Karst Development	Hydrogeologic Sensitivity to Pollution
Quaternary Deposits	None	Moderate - significant permeability
New Albany Shale	Minor	High - thin shale underlain by significant karst development
Sellersburg Limestone	Well-Developed	Extremely High - swallet and shaft drain with conduit flow
Jeffersonville Limestone	Well-Developed	Extremely High - swallet and shaft drain with conduit flow
Louisville Limestone	Well-Developed	Extremely High - swallet and shaft drain with conduit flow



**Figure 1.3 Geologic Map of the Beargrass Creek Watershed**

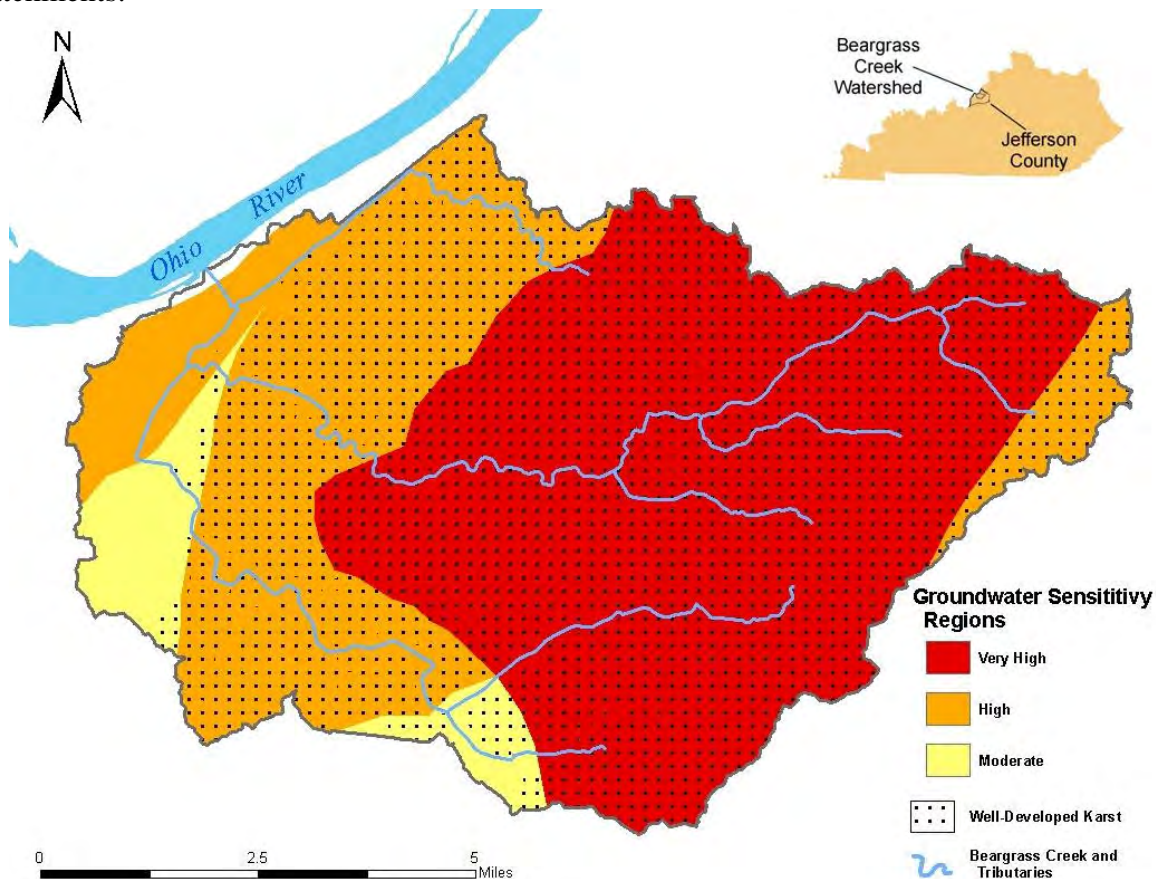
Figure 1.4 illustrates the generalized hydrogeologic sensitivity of geologic formations that underlay the Beargrass Creek watershed. The hydrogeologic sensitivity of an area is defined as “the ease and speed with which a contaminant can move into and within the groundwater system”. The hydrogeologic sensitivity ratings range across five categories. The criteria that control these sensitivity ratings are recharge to the system, flow rate and dispersion potential within the system. Low sensitivity ratings are characterized by slow, diffuse recharge, flow and dispersion. Groundwater movement is through any combination of tight fractures, intergranular porosity or bedding plane partings and discharge is localized. Higher sensitivity ratings are



characterized by rapid, turbulent recharge, flow and dispersion. Groundwater recharges via sinkholes, swallets and shaft drains, flows through solutionally enlarged fractures or conduits and dispersion may be widespread or radial (Ray et. al., 1994).

The hydrogeologic sensitivity ratings within the Beargrass Creek watershed are predominantly high. This indicates that the geologic formations underlying the Beargrass Creek watershed have relatively large infiltration pore size and groundwater flow velocity with the potential for widespread and radial dispersion patterns. Areas underlain by karst terrane can have rapid groundwater flow rates and complex flow routes. Stormwater and associated pollutants can quickly percolate through soils, or infiltrate stream swallets and sinkholes with little or no filtration or attenuation of the contaminants. Groundwater velocities within conduits are commonly measured in thousands of feet per day instead of the typical rate of inches or feet per year in non-karst systems. Ray and others (2008) note verified, traced groundwater velocities in the Beargrass Creek watershed exceeding 1.4 kilometers per day.

In order to be conservative from a management perspective, all surface runoff is modeled assuming that it flows consistent with surface catchment topography. With the exception of the small karst addition to the Middle Fork subwatershed as discussed earlier, all other karst drainage appears to be confined to the overall watershed. However, additional refinement of the resulting loading allocations may require a more in-depth karst analysis for particular catchments.



**Figure 1.4 Generalized Hydrogeologic Sensitivity and Karst Development**

## 1.7 Soils Information

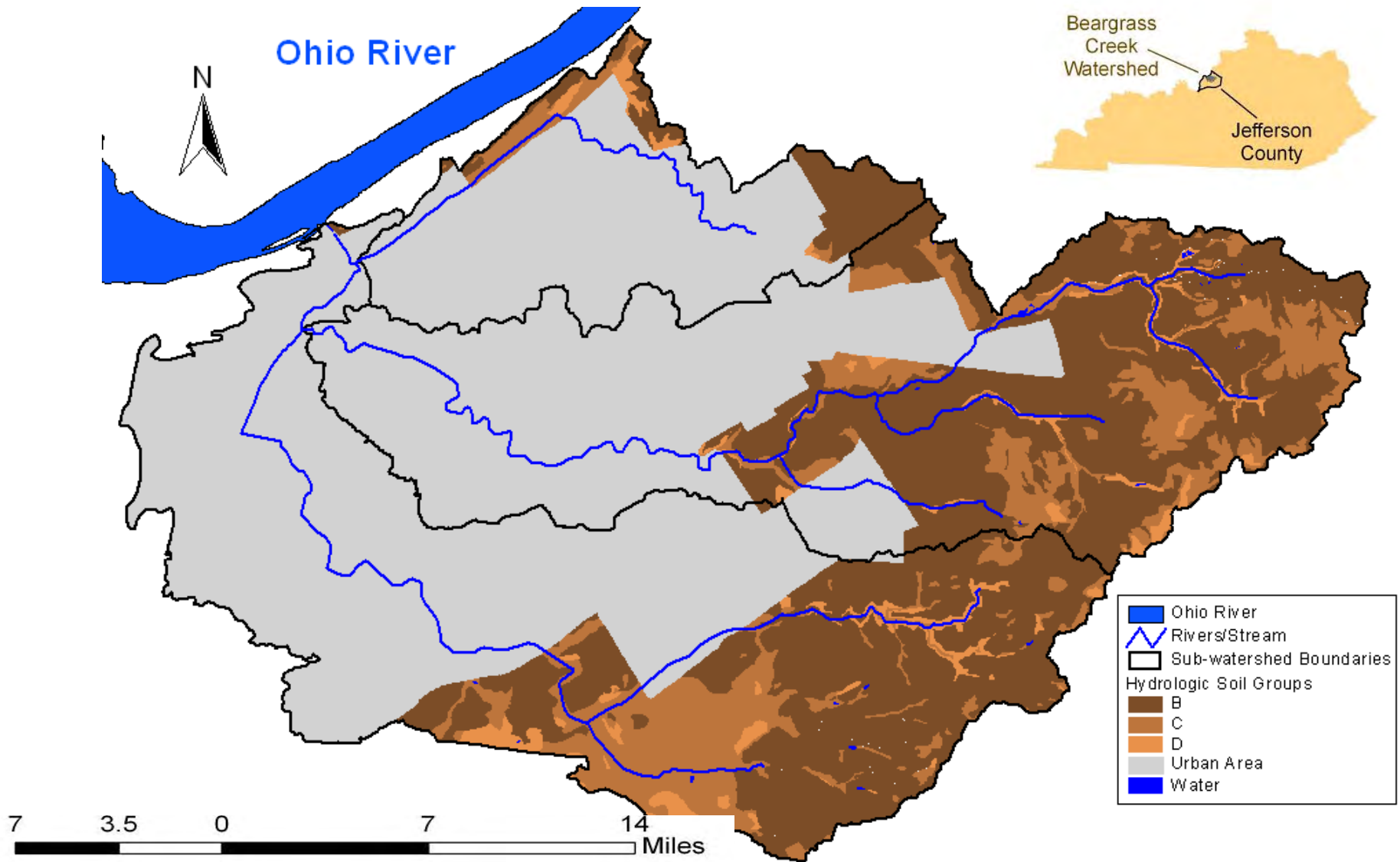
The western portion of Beargrass Creek watershed is for the most part, an urban area or is comprised of silt loams with 0-2% or 2-6% slopes. The western areas of South and Middle Fork watersheds are comprised of Dickson, Lawrence, Linside, Newark and Russellville soil series while the western portion of the Muddy Fork watershed is comprised of Newark, Taft, Sciotoville and Weinbach soil series. These soils and the urban area have relatively low infiltration rates and moderate runoff rates. The head waters of South, Middle and Muddy Forks are also comprised of silt loams with 0-2% or 2-6% slopes but they are primarily comprised of Ashton, Crider, Huntington and Russellville soil series which typically have a higher, moderate infiltration rate resulting in lower runoff. Finally, there are some very small areas lying along the stream banks near the head waters of the three forks that are comprised of soils with very high runoff rates and very low infiltration rates. These soils are primarily very rocky silt loams or silt clay loams with slopes ranging from 6 to 30%. The predominant soil series of these very rocky silt loams is Corydon (Zimmerman, et al., 1966).

Soils are classified by the Natural Resource Conservation Service into four Hydrologic Soil Groups (HSG) based on the soil's runoff potential. The four Hydrologic Soils Groups are A, B, C and D. Type A soils generally have the smallest runoff potential and type D soils the greatest. Details of this classification can be found in 'Urban Hydrology for Small Watersheds' published by the Engineering Division of the Natural Resource Conservation Service, United States Department of Agriculture, Technical Release-55' (USDA, 1982). If an area is predominantly urban in nature and the native top soils no longer exist, the Hydrologic Soil Group C is assigned to the area. The distribution of the Hydrologic Soil Groups and urban areas in the Beargrass Creek watershed can be seen in Figure 1.5.

The Middle, South and Muddy Forks of Beargrass Creek contain a great deal of soils which have low infiltration and moderate runoff rates in addition to a large urban area. As such, the majority is classified as Hydrologic Soil Group C, covering almost 60%, 70% and 85% of the sub-watershed areas in Middle, South and Muddy Forks respectively (Table 1.3). Conversely, the remaining soils in each of the sub-watersheds have moderate infiltration rates and low runoff rates. In Figure 1.5, the areas that are immediately surrounding the headwaters of the South and Middle Forks have very low infiltration rates (Zimmerman, et al., 1966).

**Table 1.3 Hydrologic Soil Groups by Percent Area for the Beargrass Sub-watersheds**

HSG	Infiltration & Runoff Rates	South Fork	Middle Fork	Muddy Fork
A	High Infiltration Rate/Very Low Runoff Rate	0.00%	0.00%	0.00%
B	Moderate Infiltration Rate/Low Runoff Rate	29.33%	39.18%	13.28%
C	Low Infiltration Rate/Moderate Runoff Rate	67.59%	58.47%	84.66%
D	Very Low Infiltration Rate/High Runoff Rate	3.01%	2.29%	2.06%



**Figure 1.5 Soils by Hydrologic Soil Group in the Beargrass Creek Watershed  
(Developed using NRCS data from KCOT, 2007; and basemap from LOJIC, 2007)**



## 1.8 Land Use Information

Urban land cover types predominate in the three Beargrass Creek sub-watersheds, characterized by soils with low infiltration and moderate runoff rates. These land cover types contain large portions of impervious surfaces and natural runoff rates are exacerbated in each of the watersheds. The land use distribution in Beargrass Creek watershed is illustrated in Figure 1.6.

South Fork has 17 municipalities plus a portion of Louisville within or on the border of the watershed. Hurstbourne Acres, Forest Hills and Jeffersontown are relatively commercialized, whereas Watterson Park and West Buechel are highly industrialized with some commercial land use patterns. The remaining small municipalities are predominantly single family residential. Just over 50% of the watershed is single family residential while approximately 11% is vacant and undeveloped. Industrial, general commercial, parks and cemeteries, multi-family residential and public semi-public land cover types are fairly evenly distributed through out the watershed being between 6% and 7.5% each. Almost 3% is classified as transportation (Table 1.4).

The Middle Fork watershed includes portions of Louisville along with 26 other municipalities within its boundaries. The land cover patterns within the small municipal boundaries are all almost 100% single family residential, resulting in fairly compact areas that are highly developed. As a result, over 50% of the total watershed is single family residential with approximately 10% being vacant and undeveloped and over 11% being classified as Industrial (Table 1.4). Public and semi public classification and general commercial and office classifications are the smallest percentage being 2.7% and 2.0% respectively. Parks, cemeteries, multi-family residential and transportation land use classifications cover between 6% and 8% each.

Seventeen municipalities lie within the Muddy Fork watershed including a portion of Louisville. The majority are suburban in nature. Almost 70% of this watershed is single family residential with industry and transportation being the only other significant land use classifications at approximately 11% and 10% respectively. The remaining land use classifications cover relatively small percentages of the watershed (Table 1.4).

The sub-watershed of the main stem of Beargrass Creek is only about 37% single-family residential with multi-family residential comprising approximately 14% of the watershed. Industrial and transportation comprise approximately 11.5% and 11% respectively, while the remaining land use classifications cover less than 4% each (Table 1.4). Because the Beargrass Creek watershed has less than 6% of the land classified as vacant or undeveloped, the potential for growth or change is limited. However, as the population grows, the density within the watershed may increase over time (Tetra Tech et al., 2007).

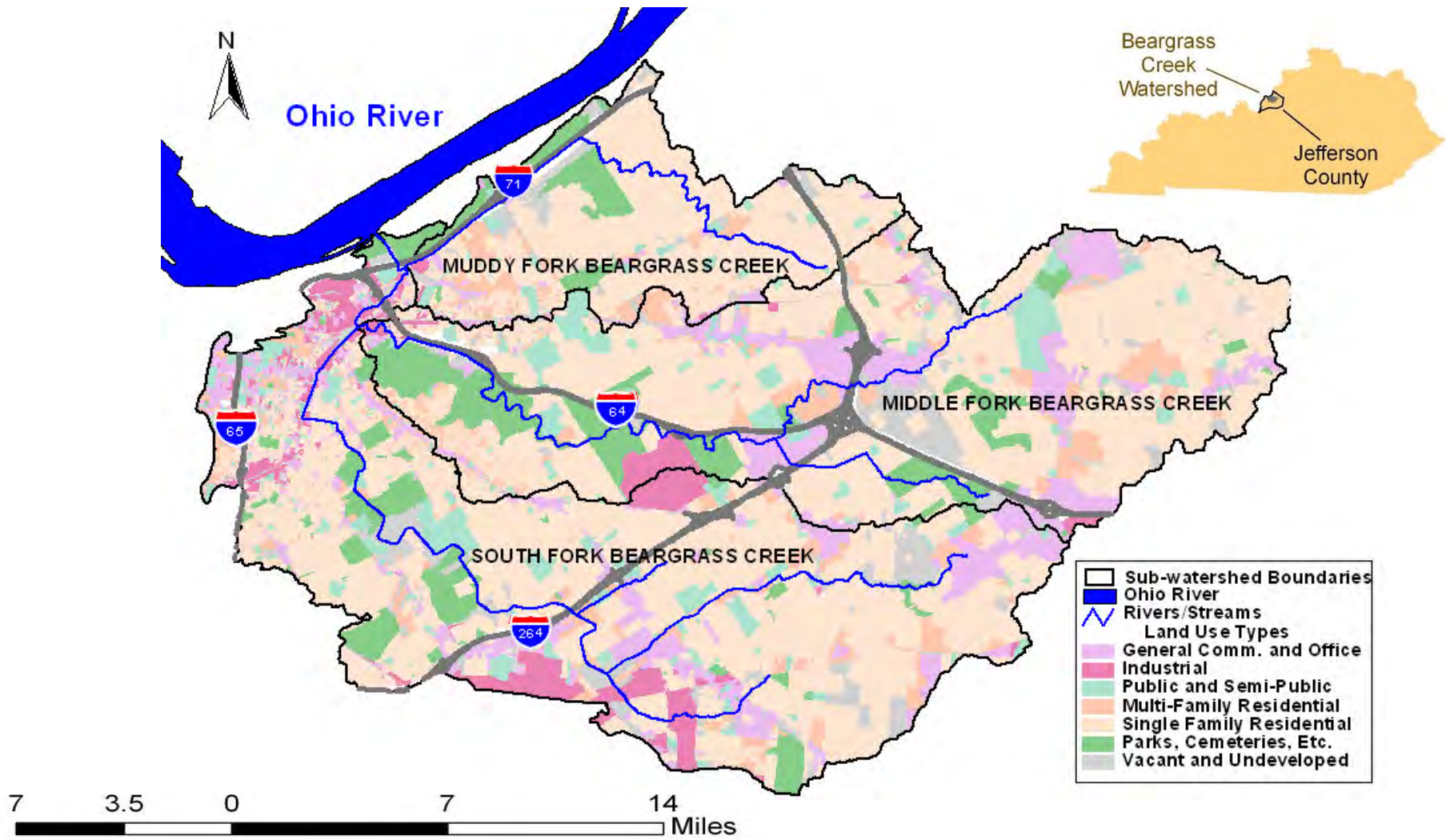


Figure 1.6 Beargrass Creek Watershed Land Use Distribution (Developed using data from LOJIC, 2007)

**Table 1.4 Beargrass Creek Sub-watershed Land Use Types by Area (square miles)  
(Tetra Tech, et al, 2007)**

Land Use Type	Middle Fork	South Fork	Muddy Fork	Main Stem Beargrass Creek	Total
Single Family Residential	12.984	13.945	5.121	0.691	32.741
Vacant and Undeveloped	2.595	3.009	0.130	0.139	5.872
Parks, Cemeteries, etc.	1.577	1.742	0.260	0.163	3.742
Public and Semi-Public	0.679	1.604	0.091	0.035	2.409
General Commercial and Office	0.500	1.726	0.014	0.151	2.391
Industrial	2.823	1.726	0.839	0.216	5.604
Multi-Family Residential	1.916	1.925	0.305	0.265	4.411
Transportation	1.944	0.721	0.776	0.200	3.641
Total	25.018	26.399	7.536	1.860	60.812

## 1.9 Hydrologic Information

Beargrass Creek watershed flows westward toward the Ohio River. The mainstem of Beargrass Creek begins at the confluence of the Middle Fork and the South Fork at river mile 1.8. Muddy Fork flows into the mainstem 0.8 miles downstream of the confluence of Middle Fork and South Fork at river mile 1.0 (see Figure 1.7).

For the purposes of TMDL development, the Beargrass Creek watershed has been split into the three sub-watersheds and then further sub-divided into 31 sub-basins (Figure 1.7). This division allows for analysis of fecal coliform contributions of both point and stormwater loads within each sub-basin. Muddy Fork, Middle Fork and South Fork have 6, 12 and 11 sub-basins respectively. The portion of Beargrass Creek that drains directly into the Ohio River has 2 sub-basins. Where necessary, the urban sub-basins were adjusted to correspond with sewershed boundaries.

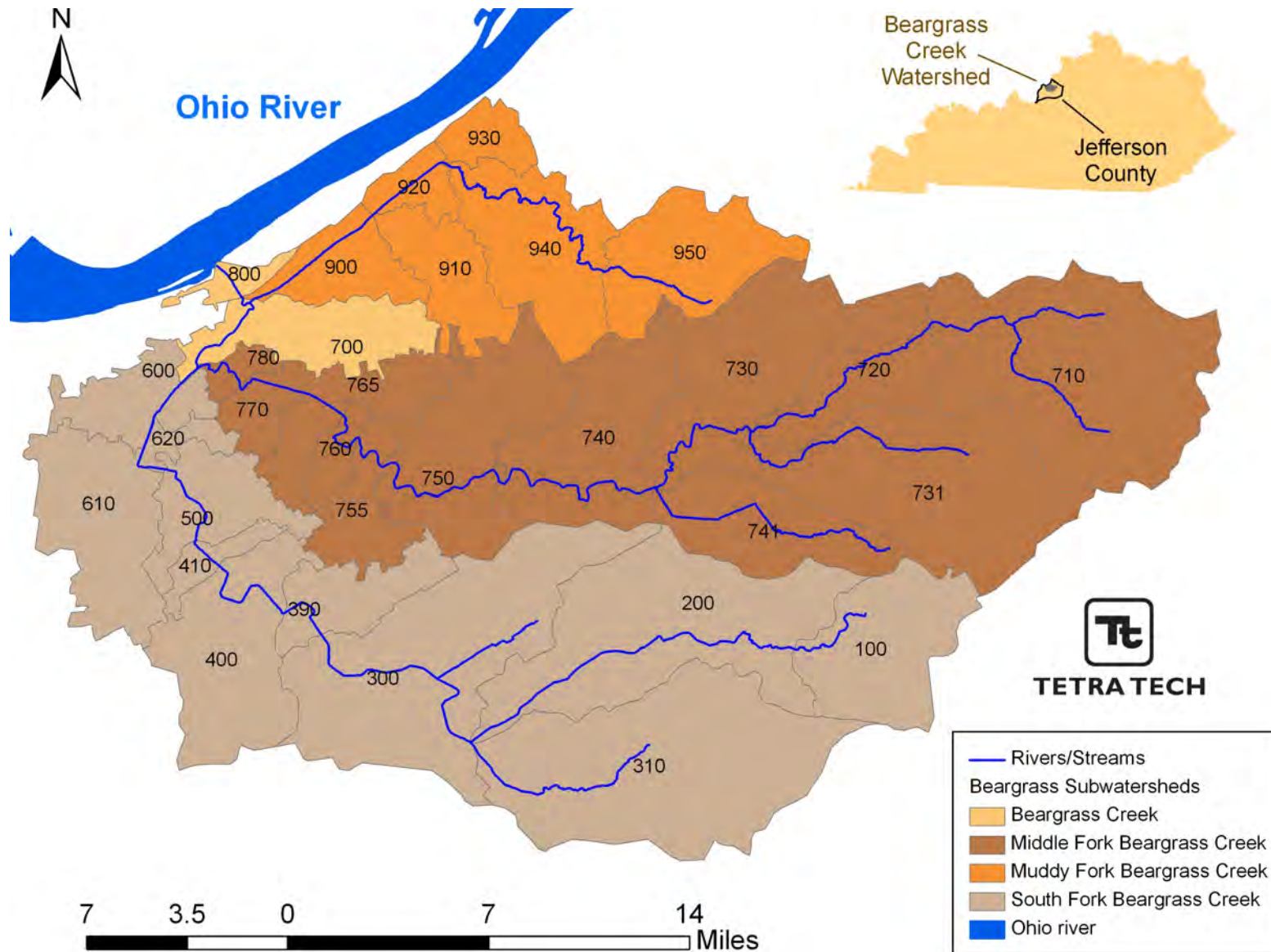


Figure 1.7 Sub-basin Delineation of the Beargrass Creek Watershed (Tetra Tech, et al., 2007)

### 1.10 Watershed and Sewer System History (Louisville, MSD, 2007)

Sometime before 1850, Louisville's first underground sewer was built in the Beargrass Creek watershed. Most likely it was the Second Street sewer, from Jefferson Street north to Beargrass Creek, which entered the river at Fourth Street. This first underground sewer was basically a ditch lined with stone and covered with stone slabs. By 1850, Louisville had become the tenth largest city in the nation, with more than 43,000 people, but the underground sewer system had reached a length of only one and one-half miles. Perhaps the biggest "sewer" project of the next decade involved enclosing the old channel of Beargrass Creek from near Fourth Street east to First Street. The Beargrass Creek Cutoff was dug along Story Avenue, routing the creek directly to the Ohio River and bypassing downtown. The old channel was enclosed, creating a sewer.

By 1860, Louisville's population had grown to more than 68,000. Urban land cover in the Beargrass Creek watershed was in its infancy and the underground sewer system was less than two miles long. By the end of the century, the population of Louisville had grown to more than 204,000. Urban land use proliferated in the Beargrass Creek watershed and the sewer system had grown to more than 99 miles.

An additional 54 miles of major sewers were designed and constructed from 1906 to 1913. The work included the city's first interceptor sewers, designed to "intercept" the sewer lines leading to Beargrass Creek and to carry the water directly to the Ohio River. It also included the first stretches of concrete channel for Beargrass Creek. Dozens of miles of major sewers were designed and built through the boom years of the 1920s and the Depression years of the 1930s. The work included miles of interceptor sewers that kept raw sewage from flowing directly into Beargrass Creek; miles of relief sewers to handle the excess water from overloaded older sewer lines. Figure 1.8 is an example of the construction methods used for these early sewers which are still in service today. More than half of the active combined sewer overflows (CSOs) existing today were constructed before this photo was taken in 1937.



The Second Street sewer downtown is an example of Louisville's earliest underground sewers — a stone-lined ditch capped by slabs of stone. Little has changed since this photo was taken in 1937 for the Commissioners of Sewerage.

University of Louisville Photo Archives, MSD Collection

**Figure 1.8 MSD's Earliest Underground Sewers (Louisville MSD, 2007)**

Another project included the city's first sewage pump station built to serve the low-lying "point" area between the old course of Beargrass Creek and the river. The river level in downtown Louisville was raised eight feet when the Ohio River dam was rebuilt in the 1920s, permanently flooding some of the old sewers and causing the water to stagnate. The station, completed in 1939, pumped the wastewater from the "point" area to the Beargrass Creek interceptor.

Additional work included construction of miles of concrete channel which replaced the natural course of Beargrass Creek, increasing its capacity to carry stormwater to the Ohio River.

Early in 1950, Louisville and Jefferson County Metropolitan Sewer District (MSD) began acquiring land for the new treatment plant. In early 1953, the Kentucky Water Pollution Control Commission briefly ordered a halt to all new sewer construction in the Louisville area until there were definite plans to build the new plant — in effect, a moratorium on development. Construction work finally started at the plant in 1956. Two years later, construction started at the Southwestern Outfall pumping station, which would pump wastewater from the system's largest sewer line to the new plant. MSD treated its first wastewater in May 1958 at the new treatment plant.

While the treatment plant was being designed and constructed, suburban expansion was booming. Urban land use was dense and well established in the downtown area and the Beargrass Creek watershed had become victim to urban sprawl. MSD had the authority to serve the entire county, but it still struggled with the challenge of serving the unsewered areas of the city. In the early 1950s the Board of Health allowed individual septic tanks where the land could accommodate them, and required small "package" sewage treatment plants where septic tanks would not work well. The board emphasized that both of these measures would be considered "temporary" and would be replaced by MSD service when MSD sewers became available. Many of these "temporary" facilities are still in use today.

In 1959, the Board of Health banned new septic tanks in the area drained by the Middle Fork of Beargrass Creek, the prime suburban development area between Taylorsville and Shelbyville Roads east of Cherokee Park and St. Matthews. Polluted water from septic tanks was creating a health hazard in ditches and streams. For the first time, all new developments in these areas would have to have sewers and any additions to the sewer systems would be sanitary only systems.

In 1962, a plan was developed to extend sanitary sewer service throughout the urbanized areas of the county by the year 2010. The plan divided the county into six study areas for sewer planning and construction including the Middle Fork of Beargrass Creek and the South Fork of Beargrass Creek where the health department had banned septic tanks.

The plan also recommended that MSD take over small sewer systems, and the "temporary" treatment plants as the service area reached them. This, too, would eventually happen but Louisville and Jefferson County both were busy with improvements and keeping up with new developments in 1965. The number of suburban cities in Jefferson County grew to 58 resulting in clusters of urban land use throughout the watershed and increasing the number of small sewage treatment plants outside MSD's service to about 175. Unfortunately, these developments conflicted with the master plan recommendations.

In 1967 MSD announced plans to build the secondary treatment facilities at the wastewater treatment plant. The cost of constructing the secondary treatment facilities was daunting, and MSD didn't have the money for large-scale construction of trunk sewers and other plants. Between 1967 and 1970, MSD absorbed a number of smaller sewer districts in the Beargrass



Creek watershed as well as other areas of Jefferson County. Eventually sewer lines were installed in Avondale and Brookhaven, the last major areas of the City of Louisville without sewers. Septic tanks remained in a few small areas of the city and MSD would occasionally build sewers to fill in these miscellaneous "left out" areas for the next 30 years.

Urban renewal brought massive changes to the downtown area in the late 1960s — including the first major effort to separate the city's sanitary and storm sewers. Throughout the urban renewal area, storm sewers would be separated from sanitary sewers, but when the new sewer lines reached the edge of the projects, they were reconnected to the old combined sewer system. In the suburbs, Bashford Manor Mall opened and soon became the busiest shopping center in the area. The number of cities in Jefferson County topped 70. The population of Jefferson County outside Louisville was about to exceed the population of Louisville. The Beargrass Creek watershed had become saturated with urban land uses.

Construction of the secondary treatment works at the Morris Forman plant began in May, 1972 just prior to the introduction of new federal standards introduced under the Clean Water Act. The plant was dedicated in July, 1976 but experienced operational problems over the next four years. Although the plant was in full operation in early 1980, federal standards were not being met. Finally, in the summer of 1985 the plant met the federal secondary treatment standards for the first time. The new standards also brought two major additions to the MSD system: the Shively and St. Matthews sewer systems. These systems had been paying MSD to take their wastewater but had been operated separately.

By the mid-1980s, there was a broad community consensus that a countywide sanitary sewer system would be best for the environment, economic development, and quality of life. The challenge was to correct the mistakes of the past by eliminating existing small treatment plants and septic tank systems, and by providing sewers for new development. Thus, construction proceeded rapidly on a countywide sewer system. Figure 1.9 is an example of one of these small package plants.



Slow progress on the countywide sewer plan led to the construction of many small, temporary "package" sewage treatment plants to serve the rapidly developing suburbs on the 1950s through the 1970s. This plant, uphill and upstream from the house beyond it, was along the Middle Fork of Beargrass Creek, where septic tanks had been banned beginning in 1959.

Courier-Journal and Louisville Times Photo

**Figure 1.9 Package Sewage Treatment Plant (Louisville MSD, 2007)**

In the 18 months ending in October, 1986, MSD entered agreements to buy 43 small plants serving 26,000 customers — about 57 percent of those who had been served by small plants. By

the end of 1987, more than 10 small plants had been eliminated, but some small plants would be operated by MSD for more than a decade before trunk sewers could reach them.

In 1990, more than 25,000 homes in Louisville and Jefferson County were still on septic tanks and many more homes and businesses were served by small treatment plants. Extending MSD service to these areas has been an ongoing priority. Another priority has been to upgrade the treatment plant to assure adequate capacity and adequate treatment. In addition, there were two major challenges in stopping stream pollution during wet weather; developing ways to deal with combined sewer overflows, and finding and eliminating sources of stormwater entering sanitary-only sewers. About 200 miles of sewer lines, or about ten percent of the system, were more than 100 years old. The majority of these lines were in the Beargrass Creek watershed, the oldest parts of the system, and these lines served the most customers. Figure 1.10 shows the construction of one of the force mains needed in Beargrass Creek.

The solution for providing MSD sanitary sewer service to much of northeastern Jefferson County involved constructing a pair of "force mains" to carry wastewater from pumping stations to the trunk lines leading to the wastewater treatment plant. In many places, the force mains had to follow the contours of the land. At the right, crews work on the mains where they emerge after crossing under Beargrass Creek.

MSD Photos by Martin E. Biemer



**Figure 1.10 Force Main Crossing Beargrass Creek (Louisville MSD, 2007)**

The Middle Fork of Beargrass Creek, which extends through Cherokee Park and eastward to Anchorage, reached a major milestone in 1994. The last small treatment plant, at Foxboro Manor, was closed. Small plants had proliferated in the Middle Fork basin after the health department banned septic tanks beginning in 1959. Over the years, more than 175 wastewater treatment plants were closed through MSD's sanitary sewer expansion program. The expansion program also eliminated thousands of individual septic tank systems.

Problems with the wastewater treatment plant continued to challenge MSD in the 1990s. While the plant met federal and state standards most of the time, the plant still exceeded pollution limits too often — especially in wet weather, when stormwater boosted the flow beyond the plant's 105 million gallon-per-day capacity. In addition, odor problems affected nearby neighborhoods.

One of the major challenges MSD currently faces is correcting problems with old sewer lines. The problems fall into three basic categories: deterioration, illicit connections, and outmoded design features. Wet weather aggravates all three. As sewer lines deteriorate, they develop cracks. Wastewater can escape into the ground through these cracks, contaminating the groundwater. Groundwater can also leak into the sewer lines through these cracks. Infiltration has been a serious problem in many older subdivisions with sanitary-only sewer lines. Water leaking into the lines can quickly overload them, causing backups into basements. In some instances, especially in the sandy areas in downtown and western Louisville, infiltration can



wash surrounding dirt into the sewer lines. This creates a growing cavity underground and may lead to a cave-in. Modern materials have made it possible to repair many deteriorating sewer lines without digging them up and replacing them. In the 1980s and early 1990s, several major old sewers were rehabilitated by slip lining.

The second basic problem, inflow, is caused by illicit stormwater connections to the sanitary-only sewers. Downspouts and basement sump pumps are the major offenders as well as driveway and walkway drains. Information on MSD's regulations in relation to illicit connections can be found in Louisville and Jefferson County MSD, 2008.

In the late 1980s, MSD re-energized the inflow and infiltration program, surveying neighborhoods where backups were common to try to determine the sources of stormwater entering sanitary sewers. In areas where the problems were especially severe, special equipment was used to seal the cracks in the sewers or reline the pipes. This reduced infiltration substantially, but infiltration through customers' leaky lines and inflow from customers' illicit connections still remain a problem.

When the capacity of the sewer system is exceeded, overflows occur and discharge into Jefferson County streams and the Ohio River — from both combined storm and sanitary sewers and sanitary-only sewers. Unfortunately, the historical practice of designing combined sewer systems and constructed overflows combined with excessive inflow and infiltration (I/I) have made CSOs and sanitary sewer overflows (SSOs) a routine problem during heavy rains.

## **1.11 Sewer System (Louisville MSD, 2007)**

### **1.11.1 Trunk System**

MSD's current system consists of a series of complex, interconnected trunk sewers, many of which lie within the Beargrass Creek watershed (Figure 1.11). The Muddy Fork watershed contains one main trunk sewer at the western end of the watershed, the Mellwood Avenue sewer. The flows carried by this trunk sewer are from the separate sewer system (the majority of the watershed) as well as flows from a very small portion of the combined system near the mouth of Muddy Fork.

The Middle Fork watershed contains the associated Middle Fork Trunk sewer which begins near the headwaters of Muddy Fork in the sanitary sewer area (SSA) and eventually runs through the combined sewer area (CSA). There is a second major sewer in the Muddy Fork watershed which is the Goldsmith Lane Trunk relief sewer. This sewer helps to alleviate flows, when downstream sewers are full, by diverting flows between the Middle Fork Trunk sewer and the Beargrass Creek Interceptor in the South Fork watershed.

The South Fork watershed contains a number of trunk sewers. The main trunk sewer is the Beargrass Creek Interceptor which runs from East to West across the watershed toward the Ohio River. The upstream end of this interceptor carries flows from the sanitary sewer system (SSS) near the headwaters of South Fork and then runs through CSA downstream carrying additional flows from the combined sewer system (CSS) as it progresses toward the Ohio River. The

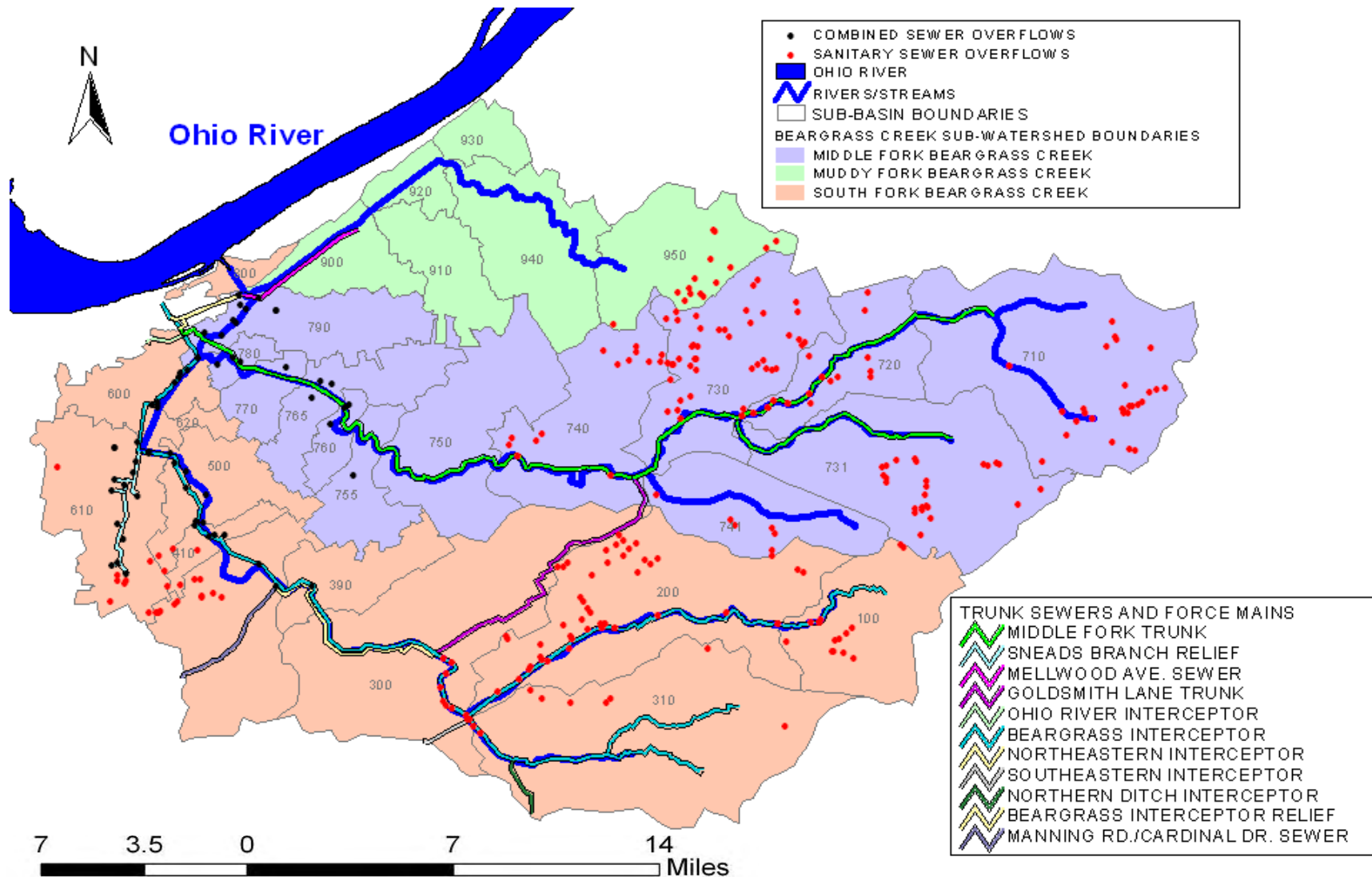
Northern Ditch Interceptor and Southeastern Interceptors join the Beargrass Creek Interceptor just south of the SSA. Additionally, just West and downstream of the intersection of the Goldsmith Lane Trunk and Beargrass Creek Interceptor, is the Beargrass Creek Relief Interceptor. This relief interceptor runs parallel to the Beargrass Creek Interceptor. It carries flows in excess of the capacity of the main interceptor by filling through an overflow weir from the main interceptor when it is full. After the Beargrass Creek Relief Interceptor, flows are introduced to the Beargrass Creek Interceptor from the Manning Rd./Cardinal Drive Trunk sewer and from the Sneads Branch Relief Interceptor further west in the CSA.

When built, these relief interceptors and trunks provided adequate capacity to carry flows to the treatment plant. Unfortunately, even with the relief sewers and flow diversion from one watershed to another, the prevention of overflows into the creeks and ultimately into the Ohio River has not been attained.

#### 1.11.2 Sanitary Sewer Overflows

The majority of the MSD sewer system has aged and many of the old sewer lines are suffering from deterioration. In addition, the system contains thousands of illicit connections. The combination results in excessive infiltration and inflow (I/I) in the sanitary only system. The system becomes overloaded during wet weather events when the sump pumps, rain gutters and foundation drains are pumping stormwater into the sewer system and when groundwater is leaking into the cracked pipes. The excess water causes the sanitary lines to become full and the sewer lines become surcharged causing basement backups or overflows at manholes.

To prevent property damage and to remove the sanitary/stormwater mix from the streets, the points of overflow and surcharge in the system are manually pumped to the nearest drainage ditch or surface water body and bypasses occur at the pumping stations in the sanitary system. They are located outside the areas of oldest infrastructure and outside the combined sewer system. These SSOs are occurring in the suburbs, in the areas of highest development during the 1960s and 1970s served by sanitary only lines. Numerous SSOs can occur in the Beargrass Creek watershed, with the number of SSOs discharging during a wet weather event being dependent upon the intensity and duration of the rainfall. During wet weather events these overflows are discharged to the surface waters of all three forks of Beargrass Creek. Figure 1.11 illustrates the location of documented SSOs and the number of documented SSOs that have occurred in each sub-basin (Table 1.5).



**Figure 1.11 Locations of CSOs, Documented SSOs and Major Trunk Sewers**  
 (Developed using data from LOJIC, 2007; and base map from Tetra Tech et al., 2007)

### 1.11.3 Combined Sewer Overflows

MSD has 57 permitted CSOs with 39 individual discharge points (Figure 1.12 and Table 1.5). These discharge points are constructed outfalls that were built into the combined sewer system in the Beargrass Creek watershed and a single discharge point may carry the flows from multiple CSOs. These points intentionally discharge when pipes become overloaded due to the inflow of excessive amounts of stormwater and often occur in the system upstream of bottlenecks in which the pipes entering are larger than the receiving pipes. Constructed discharge points were an acceptable practice when designing combined sewers in the late 1800's and early 1900's since both sanitary flows and stormwaters flows were being addressed. Table 1.6 presents CSOs by sub-basin and includes the year the CSO was built. This practice was undertaken from as early as 1897 to as late as 1986. However, the practice of designing constructed overflows was halted shortly thereafter because it had become apparent that the water quality of Beargrass Creek suffered due to these overflows.

Unfortunately, the overflows that were built into the system have not been easily addressed. Some have been disconnected, closed or separated so that only stormwater discharges from the constructed outfall. One has had treatment provided prior to discharge and many have had solids and floatables controls installed. To improve the water quality in Beargrass Creek, those that remain still need to be addressed or closed and additional treatment may be required, even at those discharge locations receiving preliminary treatment. Note that CSOs are located in the areas of oldest infrastructure closest to the Ohio River and that some CSO discharge locations serve as single points that discharge the flows from multiple CSOs (Figures 1.11 and 1.12).

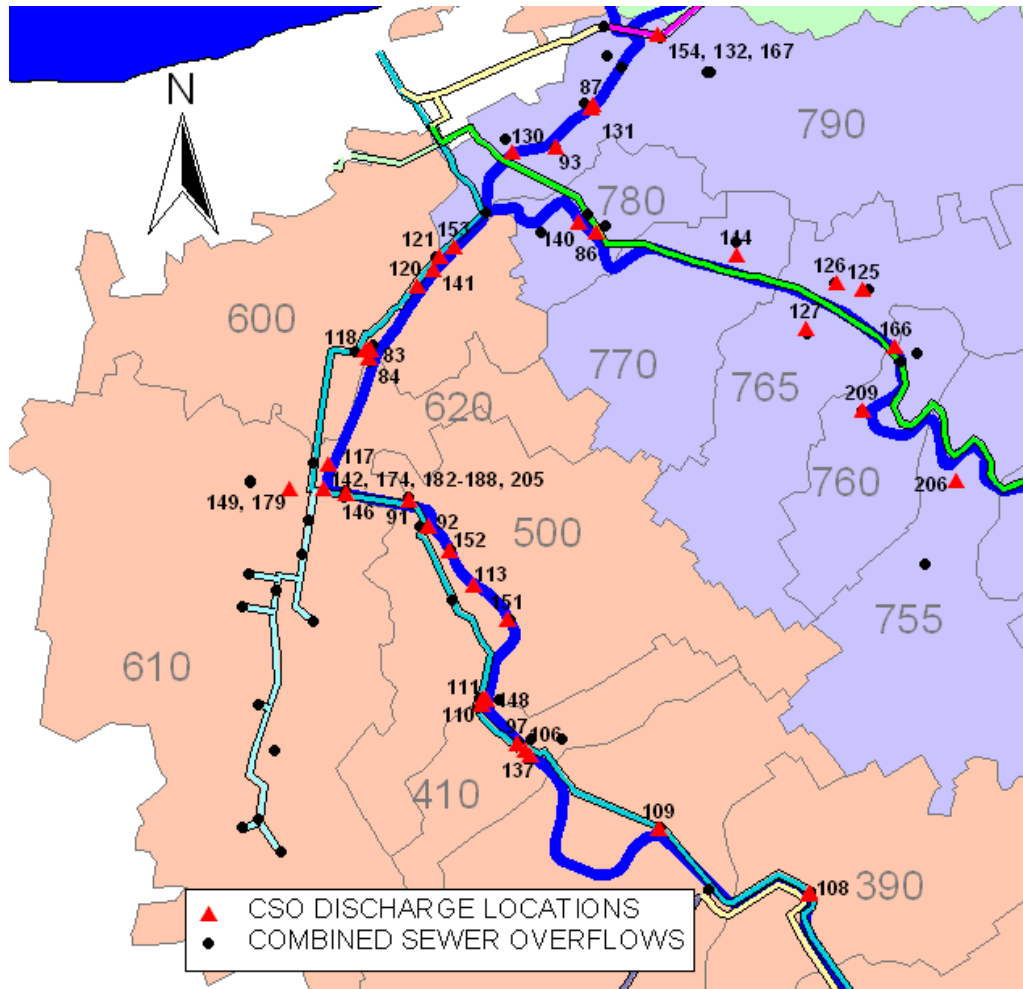
**Table 1.5 Numbers of CSOs and Documented SSOs\* by Sub-basin**

Sub-Basin	# Documented SSOs	Sub-Basin	# Active CSOs
100	14	390	1
200	49	400	2
300	8	410	4
310	13	500	7
400	12	600	5
410	4	610	15
500	2	620	3
610	8	755	1
710	28	760	3
720	16	765	3
730	42	770	1
731	25	780	3
740	15	790	12
741	6		
950	15		

\*The number of SSOs will fluctuate as capacity is created and based upon the magnitude of wet weather.

**Table 1.6 CSO Year Built by Sub-Basin**

390		400		500		610	
CSO	Year	CSO	Year	CSO	Year	CSO	Year
108	1932	18	1966	91	1912	117	1912
<b>410</b>		109	1932	92	1930	142	1897
<b>CSO</b>	<b>Year</b>	<b>755</b>		111	1986	146	1912
97	1962	<b>CSO</b>	<b>Year</b>	113	?	149	?
106	1949	206	1923	148	1986	174	?
110	1931	<b>790</b>		151	1911	179	1924
137	?	<b>CSO</b>	<b>Year</b>	152	1912	180	?
<b>600</b>		81	1950	<b>760</b>		182	1953
<b>CSO</b>	<b>Year</b>	82	1912	<b>CSO</b>	<b>Year</b>	183	1927
118	?	87	?	162	?	184	1957
119	1912	88	1937	166	1931	185	1957
120	1912	93	1937	209	1912	186	1949
121	?	130	?	<b>765</b>		187	?
141	?	131	1937	<b>CSO</b>	<b>Year</b>	188	1909
<b>620</b>		132	1937	125	1927	205	1909
<b>CSO</b>	<b>Year</b>	145	1939	126	1930	<b>780</b>	
83	?	153	1912	127	?	<b>CSO</b>	<b>Year</b>
84	?	154	1974	<b>770</b>		80	1951
147	?	167	1937	<b>CSO</b>	<b>Year</b>	86	1923
				144	1977	140	1977



**Figure 1.12 Enlargement of CSO Area with CSO Discharge Locations in the Southern Portions of South Fork and Middle Fork (see Figure 1.11) (Developed using data from LOJIC, 2007; and base map from Tetra Tech et al., 2007)**

### 1.12 Stormwater Management System

Stormwater within the combined sewer area is diverted to catch basins that drain into the combined sewer system which collects both sewage and stormwater runoff. As previously discussed, these sewers typically have relief structures so that when the pipes become overloaded with too much flow during wet weather, the water exits the sewer system via a CSO into the nearest body of water preventing back-up into the street or homes.

In areas where separate sanitary sewers and stormwater sewers were installed, stormwater is collected through catch basins that drain into stormwater only lines. If stormwater sewers do not exist, drainage ditches typically serve to intercept surface runoff. Both of these sources of stormwater flow are conveyed to intermittent surface water channels and ultimately diverted to the larger perennial streams and the Ohio River.

In some cases, stormwater may be diverted through stormwater detention facilities, where the runoff is collected and released slowly to control the peak discharge and to minimize flooding. A map of the major detention facilities within the Beargrass Creek watershed is provided in Figure 1.13. Some facilities are large regional detention basins while others are smaller, private, site detention basins. Muddy Fork has three of the latter and the owners of these site detention basins receive drainage fee credits for their contribution to the stormwater management system.

South Fork contains 20 smaller detention facilities and one regional detention facility. The regional detention facility known as the “Dry Bed Reservoir” is approximately 54-acres. The reservoir is a flood control basin with a tributary area of approximately 1,500 acres that is largely developed.

The City of Lyndon partnered with MSD to build a regional detention basin in Middle Fork. Another regional facility has been installed in the Woodlawn Park area to reduce downstream flooding in Beechwood Village and reduce surface water backup in Woodlawn Park. In addition to the two regional detention basins, 17 site detention facilities lie within the watershed. A summary of the wastewater and stormwater system statistics by sub-basin is provided in Table 1.7.

**Table 1.7 Aggregate Summary of Wastewater and Stormwater Statistics by Sub-basin**

<b>SUB-WATERSHED</b>	<b>Area (sqmi)</b>	<b>% Impervious</b>	<b># Documented SSO* Locations</b>	<b># Documented CSO Locations</b>	<b># Detention Basins</b>
<b>BEARGRASS</b>					
	1.9	10.3	0	10	0
<b>MIDDLE FORK BEARGRASS CREEK</b>					
	25.0	22.2	132	12	17
<b>MUDDY FORK BEARGRASS CREEK</b>					
	7.5	11.4	15	0	3
<b>SOUTH FORK BEARGRASS CREEK</b>					
	26.4	29.1	110	38	23

\*The number of SSOs will fluctuate as capacity is created and based upon the magnitude of wet weather.

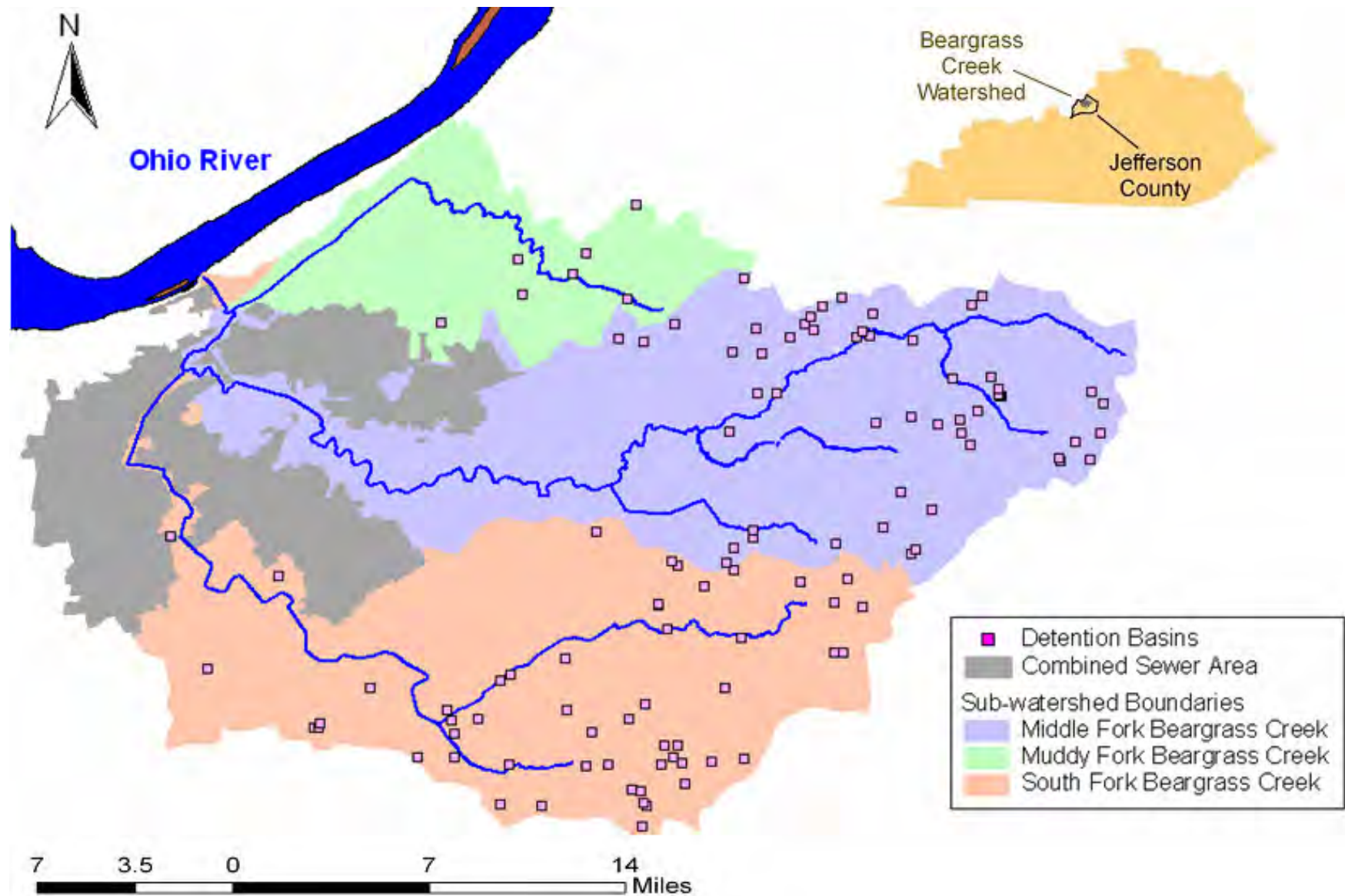


Figure 1.13 Stormwater Detention Facilities within Beargrass Creek Watershed (Developed using data from LOJIC, 2007)



The main stem of Beargrass has no SSOs or detention basins and the CSO load is the only point source contributor. The number of CSOs in the sub-basin, which is less than 2 square miles in area, has almost as many as Middle Fork with an area of 25 square miles. The percent of impervious surface is 10% of the total main stem area. The remaining three sub-watersheds all have a number of locations at which there have been documented SSOs and they all contain stormwater detention basins. Muddy Fork however, has no SSOs.

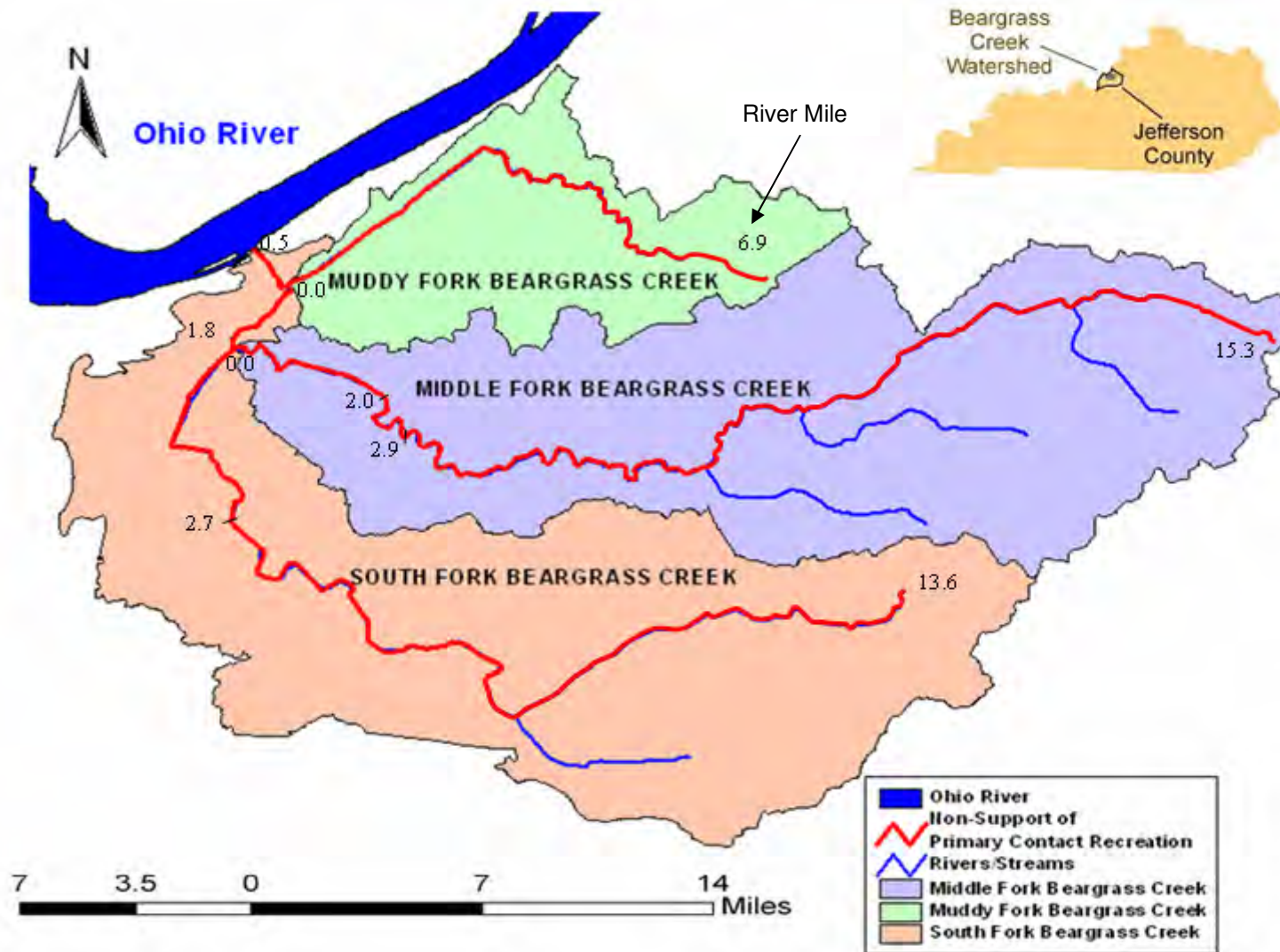
### 1.13 Waterbody 303(d) List Status

401 KAR 10:030 stipulates that there are four antidegradation categories in which surface waters can be placed including outstanding natural resource water, exceptional water, high quality water, and impaired water. The stream reaches of Beargrass Creek that are on the 303(d) list fall into the antidegradation category of impaired.

The South Fork of Beargrass Creek was originally listed on the 1990 303(d) list. The 2010 303(d) report indicates that the South Fork of Beargrass Creek is impacted by fecal coliforms from river mile 0.0 to 13.6 with SSO inputs to the stream above river mile 6.1 and CSO inputs from river mile 6.1 to the mouth of Beargrass Creek. There are two impaired segments in this reach, from river mile (RM) 0.0 to 2.7 and from RM 2.7 to 13.6. Thus, 13.6 miles of South Fork remain on the 303(d) list for fecal coliforms which are impairing the designated use for primary contact recreation, or swimming. The Middle Fork of Beargrass Creek was also originally listed in the 1990 report and carried forward to the 2010 303(d) report. Middle Fork is impacted by fecal coliforms from river mile 0.0 to 15.3. There are three impaired segments for this reach, from RM 0.0 to 2.0, RM 2.0 to 2.9, and RM 2.9 to 15.3. This stream reach is suspected to be impaired due to CSOs and urban runoff introducing fecal coliforms which continue to be a problem. In the 1990 report, Muddy Fork was listed as partially supporting primary contact recreation from river mile 2.3 to 6.9, but subsequent data showed that the stream was not supporting the primary contact recreation (PCR) designated use. The Muddy Fork listing for non-support of PCR due to fecal coliforms applies to the stream reach from river mile 0.0 to 6.9. Table 1.8 indicates the stream reaches and possible sources of pollutants. Figure 1.14 illustrates the stream reaches listed on the 303(d) list.

**Table 1.8 Beargrass Ck.Impacted Streams/Suspected Pollutant Sources (KDOW, 2008)**

	Beargrass Creek River Mile		
	South Fork	Middle Fork	Muddy Fork
<b>Impaired Use</b>			
Primary Contact Recreation (Swimming): Non-support	0.0 - 13.6	0.0 - 15.3	0.0 - 6.9
<b>Suspected Sources</b>			
Municipal Point Sources (Package Plants)	X	X	X
Urban Runoff/Storm Sewers	X	X	X
Land Disposal	X	X	X
Combined Sewer Overflows	X	X	
Sanitary Sewer Overflows	X	X	



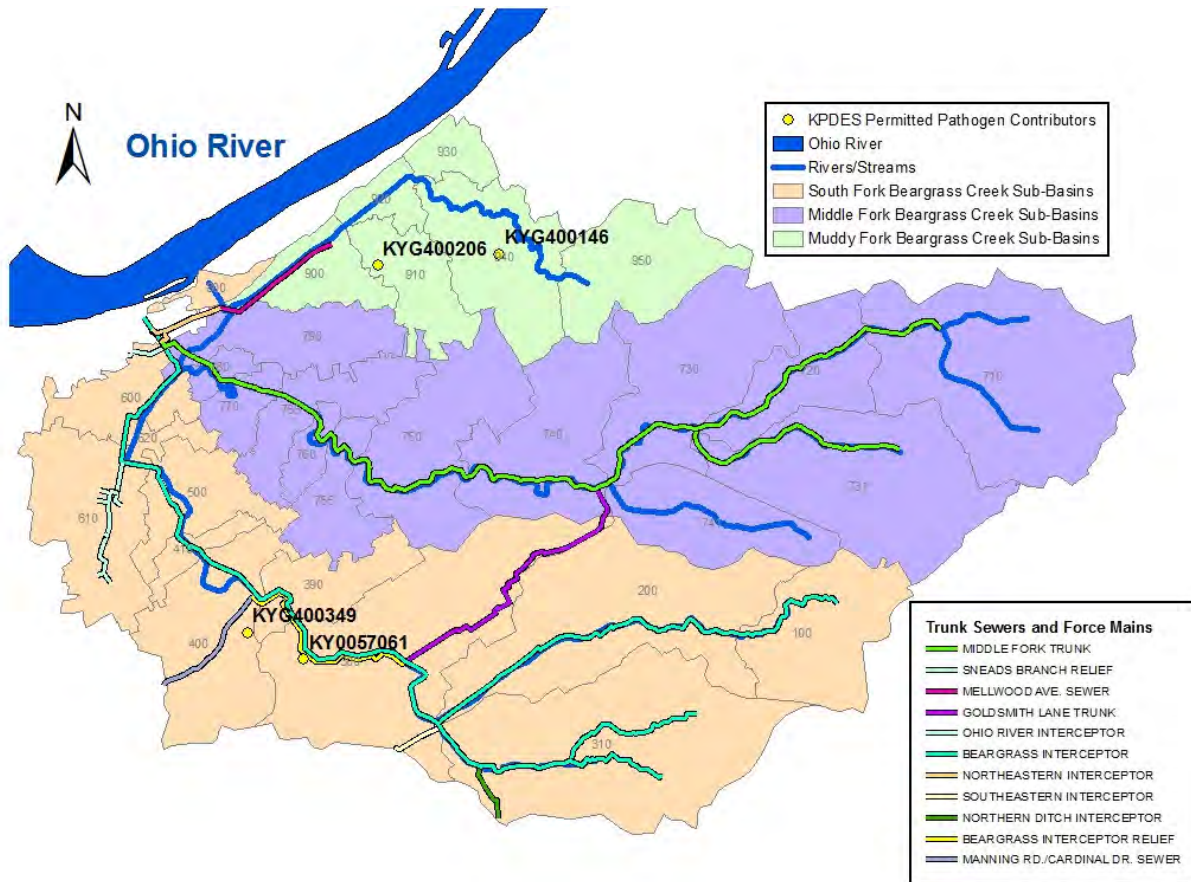
**Figure 1.14 Impaired Steam Segments and Stream Miles in the Beargrass Creek  
(Developed using data from KDOW 2008;base map from LOJIC, 2007)**

**1.14 KPDES Permitted Discharges**

In addition to permitted CSOs, the watershed also contains four additional KPDES permits. These are summarized in Table 1.9 and highlighted in Figure 1.15.

**Table 1.9 KPDES Permits**

KPDES Permit	Description	Subbasin	Latitude	Longitude
KY0057061	Louisville Zoo: Outfall 001 Outfall 002	300	38.204722	-85.700556
KYG400146	Residence	940	38.272222	-85.661111
KYG400206	Residence	910	38.27	-85.686389
KYG400349	Residence	400	38.208889	-85.7125



**Figure 1.15 KPDES Permitted Fecal Coliform Contributors**

## 2.0 MONITORING

The monitoring history of MSD consists of a combination of monitoring and sampling efforts at various times over the past 20 years, much of which continues to date. These efforts include monitoring rainfall and stream flow. In addition, continuous water quality monitoring and discrete water quality sampling are performed. Finally CSO, SSO, and in system sampling and flow monitoring are conducted by MSD on an as needed basis. By analyzing the various sampling and monitoring data the various point and nonpoint source loads can be determined as can their impact on the receiving waters. Ultimately, the reduction in these loadings can be quantified such that water quality standards in the receiving waters of Beargrass Creek can be achieved.

### 2.1 Rain Gage Network

The first rain gages were installed in 1991 as a joint effort between MSD and the USGS. The rain gage information was to be used for MSD studies and USGS research. In 1997, MSD took over sole responsibility of the rain gage network. These data logger rain gages were non-telemetered and required MSD personnel to download the stored information. Although labor intensive, these rain gages work extremely well and remain in operation.

In 1997, eleven telemetry-equipped rain gages were installed. The primary purpose was to provide real-time data for emergency response support. The majority were installed at MSD facilities located throughout Jefferson County. For the purposes of emergency response support, these rain gages performed adequately. However, these telemetered rain gages did not meet the requirements of the Real Time Control (RTC) program. Their geographic distribution and the telemetry system used at the time were deemed insufficient to provide the needed information in a timely manner.

In the spring of 2003, fifteen new telemetry-equipped rain gages were installed throughout Jefferson County. This updated rain gage system is used to calibrate weather service Nexrad radar with rain gage data in order to provide rainfall predictions at least two hours in advance. This information will be utilized by both MSD's RTC project and for emergency response preparation. The new rain gage network also provides a better geographical coverage of Jefferson County.

Because MSD has gone through a number of stages developing their rain gage network, most sites do not have a period of record from inception of the rain gage network to the present date. The original rainfall tipping bucket gages located inside or near the Beargrass Creek (BGC) watershed are as noted in Table 2.1. These gages were phased out between 2001 and 2003 to be replaced by gages with telemetry equipment for transmitting the rainfall data to MSD (Table 2.2). A further change was made in mid-2003, replacing the manual and telemetered sites with a combination of reference sites and a radar system for estimating precipitation (Table 2.3). In order to generate point source data to correspond to historical rain gage data, a combination of available datasets must be used to develop a continuous time series at historically monitored locations.

To develop a full set of precipitation data at the seven original gages, the period from 1/2002 to 12/2003 was generated for four of the gages using a missing station analysis based on the remaining stations. The period from 1/1993 to 6/1996 was also replaced for station RG33. This provided a complete dataset at the seven gages from 1993 - 2003. Extension of the rainfall dataset was done using the radar rainfall estimates. The 1-km<sup>2</sup> pixels of the radar system were overlaid with the Beargrass Creek rainfall Thiessen polygons and combined to generate the 5-min radar estimates of precipitation at each point gage location. Comparison of the point rain gage data from 6/2003-12/2003 has allowed for assessment of bias between the point gage and radar measurement methods. This combination of rain data sets provides a complete period of record for the seven rain gages in Beargrass Creek (see Figure 2.1).

**Table 2.1 Long-term Meteorology and Precipitation Data in Beargrass Creek Watershed**

Gage/Location	Time step/Variable	Period of Record
COOP154954/ STANDIFORD FIELD	Hourly/ air temp., precip., wind speed, cloud cover, solar radiation, and dew point	1/1/90 - 12/31/04
RG06/ SENECA PARK GOLF COURSE <sup>1</sup>	5-min/ precipitation	5/3/91 - 9/30/03
RG07/ LOUISVILLE WATER CO. TOWER <sup>1</sup>	5-min/ precipitation	5/3/91 - 12/31/01
RG08/ MCMAHAN FIRE STATION <sup>1</sup>	5-min/ precipitation	5/25/91 - 12/31/01
RG11/ EAST COUNTY GOV'T CTR. <sup>1</sup>	5-min/ precipitation	5/23/91 - 9/30/03
RG14/ GHEENS ACADEMY	5-min/ precipitation	6/14/91 - 9/30/03
RG19/ SO. FORK BEARGRASS <sup>1</sup>	5-min/ precipitation	6/17/91 - 9/30/03
RG29/ MSD MAIN OFFICE <sup>1</sup>	5-min/ precipitation	9/4/91 - 12/31/01
RG33/ ST. MATTHEWS FIRE STATION <sup>1</sup>	5-min/ precipitation	6/1/96 - 12/31/01
1 Original Tipping Bucket Gages		

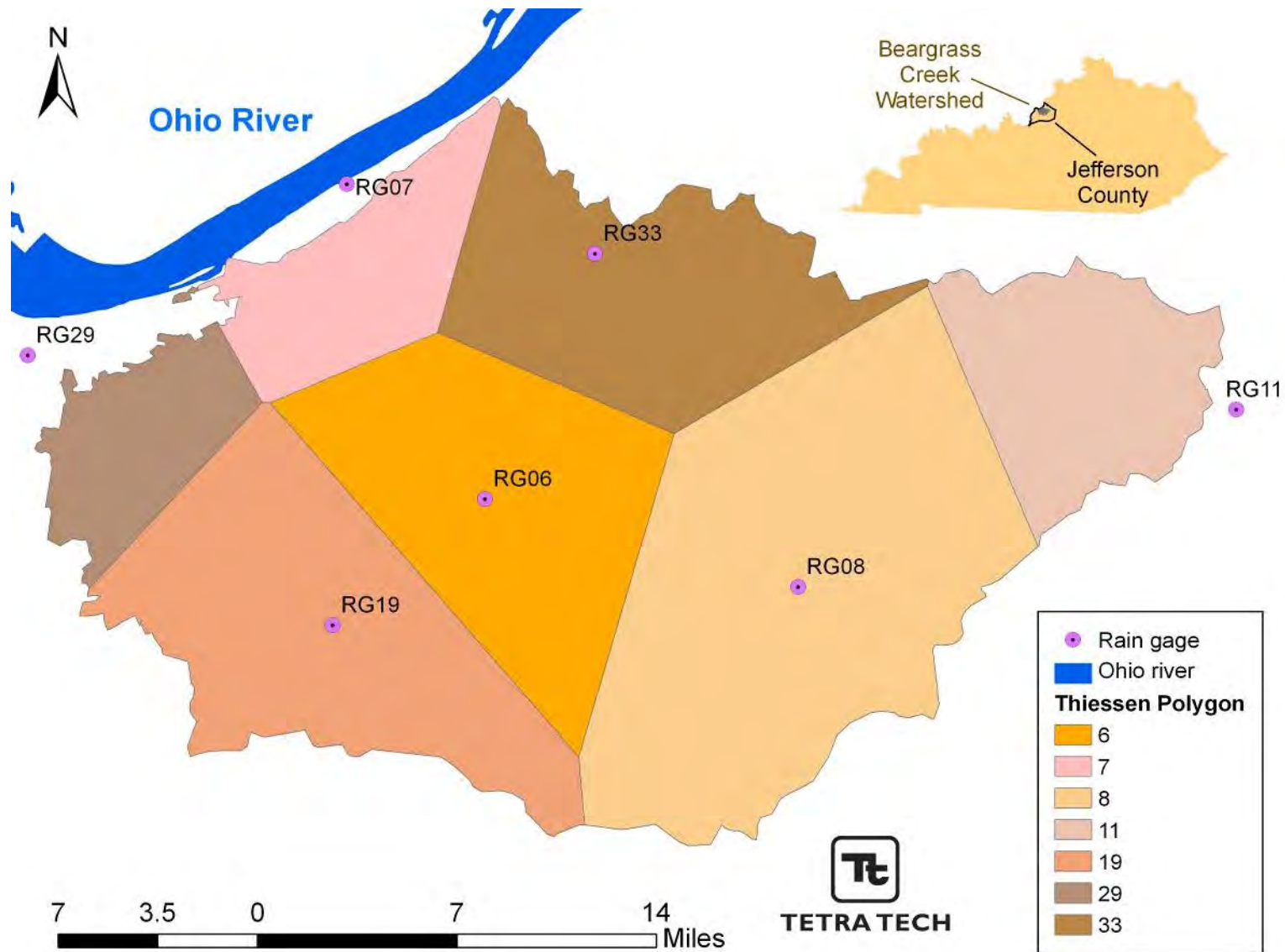
**Table 2.2 Interim Precipitation Gages in Beargrass Creek Watershed**

Gage/Location	Time step/Variable	Period of Record
RG35/ JEFFERSONTOWN TP	5-min/ precipitation	11/21/19 - 5/20/20
RG36/ BUCHANAN PS/FPS	5-min/ precipitation	1/6/98 - 5/15/03
RG41/ NIGHTINGALE PS	5-min/ precipitation	8/14/00 - 5/20/03
RG42/ MUDDY FORK PS	5-min/ precipitation	8/5/00 - 5/15/03
RG45/ UPPER MIDDLE FORK PS	5-min/ precipitation	8/4/00 - 5/18/03

**Table 2.3 Precipitation Gages to Support Radar System in Beargrass Creek Watershed**

Gage/Location	Time step/Variable	Period of Record
TR05/ BEARGRASS CREEK PS	5-min/ precipitation	5/20/2003 – present
TR13/ ST MATTHEWS ELEM. SCHOOL	5-min/ precipitation	5/20/2003 – present
TR15/ JEFFERSONTOWN TP	5-min/ precipitation	5/20/2003 – present





**Figure 2.1 Rain Gage Network in and around Beargrass Creek Watershed (Tetra Tech, et al., 2007)**

Note: Thiessen Polygon number corresponds to rain gauge “RG” number.

## 2.2 Streamflow Network

MSD and the USGS have partnered since 1988 on the collection of surface water data in Jefferson County. Data have been collected at a network of fixed stream locations across Jefferson County and at several locations (“controls”) outside of the county. The network currently consists of 24 locations, each having paired “mini monitor” water quality meter (MSD owns, operates and maintains) and a stream flow gage (USGS owns, operates and maintains). This pairing of “continuous” (5 to 15 minute data, 24 hrs/day, 365 days/year) stream flow and “continuous” (15 minute data, 24 hrs/day, 365 days/year) water quality data provides information to:

- establish baseline conditions and track long term changes (trends) in stream water quality,
- determine the number and magnitudes of water quality violations,
- evaluate improvements in water quality following sewerage and removal of package, wastewater treatment plants,
- develop TMDLs for impaired water bodies,
- develop tools which evaluate the effectiveness of different CSO and SSO control, strategies and stormwater best management practices (BMPs).

In 2007, the program included costs to operate and maintain 24 stream flow gages, five crest stage gages and one national atmospheric deposition program (NADP) monitor. Of the 24 stream flow gages, five are within the Beargrass Creek watershed boundaries with two on South Fork, two on Middle Fork, and one on Muddy Fork. Table 2.4 lists the Beargrass Creek gages and Figure 2.2 displays their geographic locations within the watershed.

**Table 2.4 Stream Gaging Stations in the Beargrass Creek Watershed**

USGS Gage	Location	Period of Record
03292500	South Fork Beargrass Creek at Trevilian Way	12/12/1939 - present
03292550	South Fork Beargrass Creek at Winter Ave	10/1/1998 - present
03293000	Middle Fork Beargrass Creek at Old Cannons	8/4/1944 - present
03293500	Middle Fork Beargrass Creek at Lexington Rd	10/1/2003 - present
03293530	Muddy Fork Beargrass Creek at Mockingbird Valley	10/1/2002 - present

The stations at Trevilian Way (USGS03292500) and Old Cannons (USGS03293000) provide the best long-term records for evaluation of flow regimes and calibration of hydrology. These gages are above the CSO impacted areas and will be used to establish the correct hydrological parameters for stream flow, watershed runoff, I/I in the sanitary system, and SSO predictions. While the gage at Winter Ave (USGS03292550) has a shorter period of record, it is downstream of 12 of the 39 CSO locations and will be used to develop hydrological parameters including watershed runoff and CSO prediction. See Figure 2.2 for the geographic distribution of these locations.

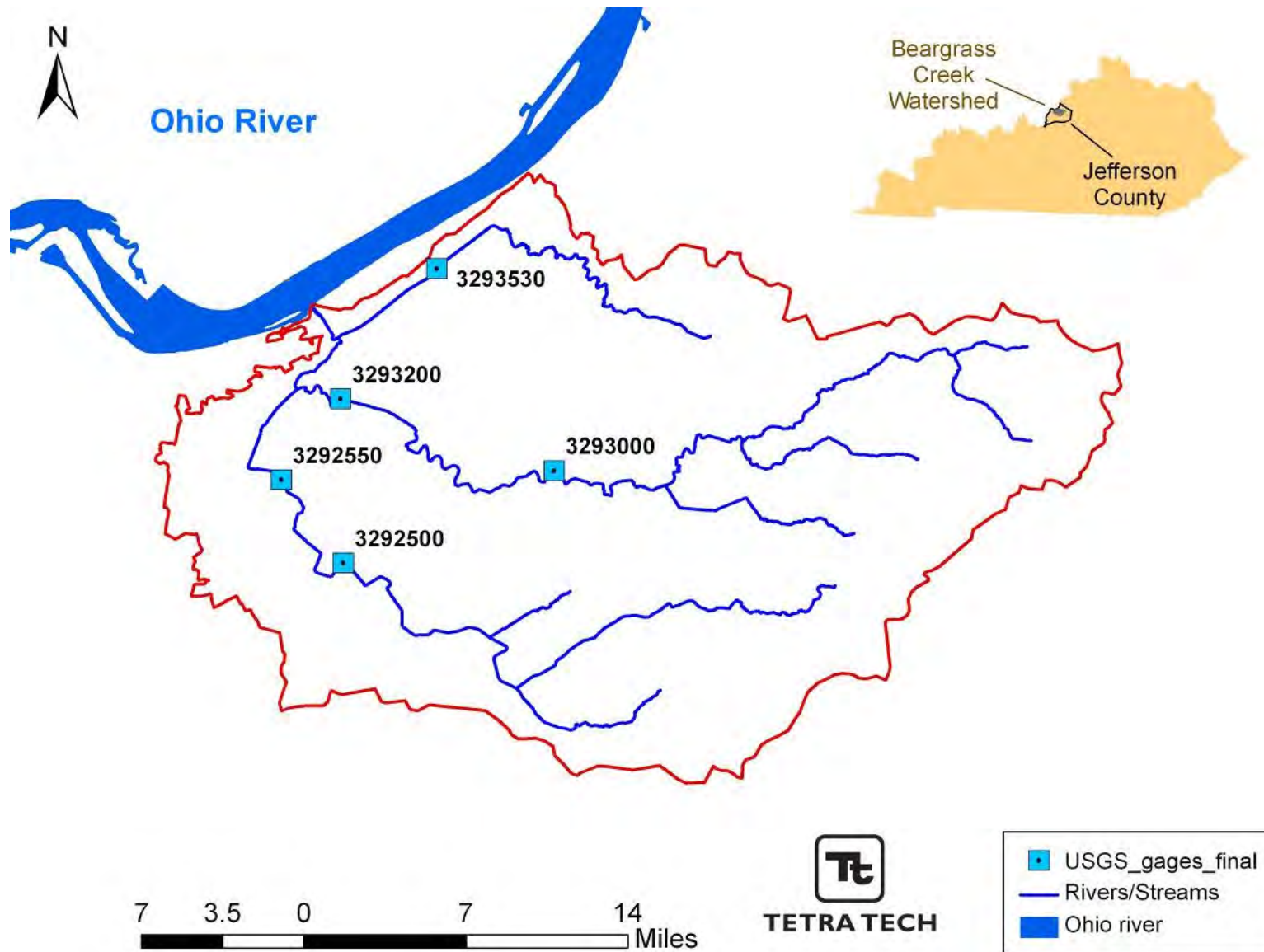


Figure 2.2 USGS Stream Gage Locations (Tetra Tech, et al., 2007)



### **2.3 Continuous Water Quality Monitoring**

MSD has monitored Jefferson County streams for approximately 15 years. After 11 years of monitoring, an analysis of the data was performed. The analysis indicated that the elimination of small package wastewater treatment plants, in conjunction with sewerage, resulted in significant pollutant load reductions to streams during low flow conditions.

In an effort to better characterize stream impacts, the monitoring program was revised to include high temporal and spatial resolution, monitoring for fewer parameters, and increased wet weather sampling. The parameters that are monitored every 15 minutes are water temperature, air temperature, stream flow, dissolved oxygen levels, specific conductance, barometric pressure and pH. This Long Term Monitoring Network (LTMN) was developed in conjunction with the USGS stream flow network to provide a better understanding of water quality impacts within Jefferson County streams.

Beargrass Creek watershed has five locations in the LTMN with paired mini-monitors and USGS stream flow gages. In addition to the five LTMN sites, there are 2 additional sites that are being continuously monitored in the watershed specifically in support of the development of this TMDL. These locations can be seen in Figure 2.3.

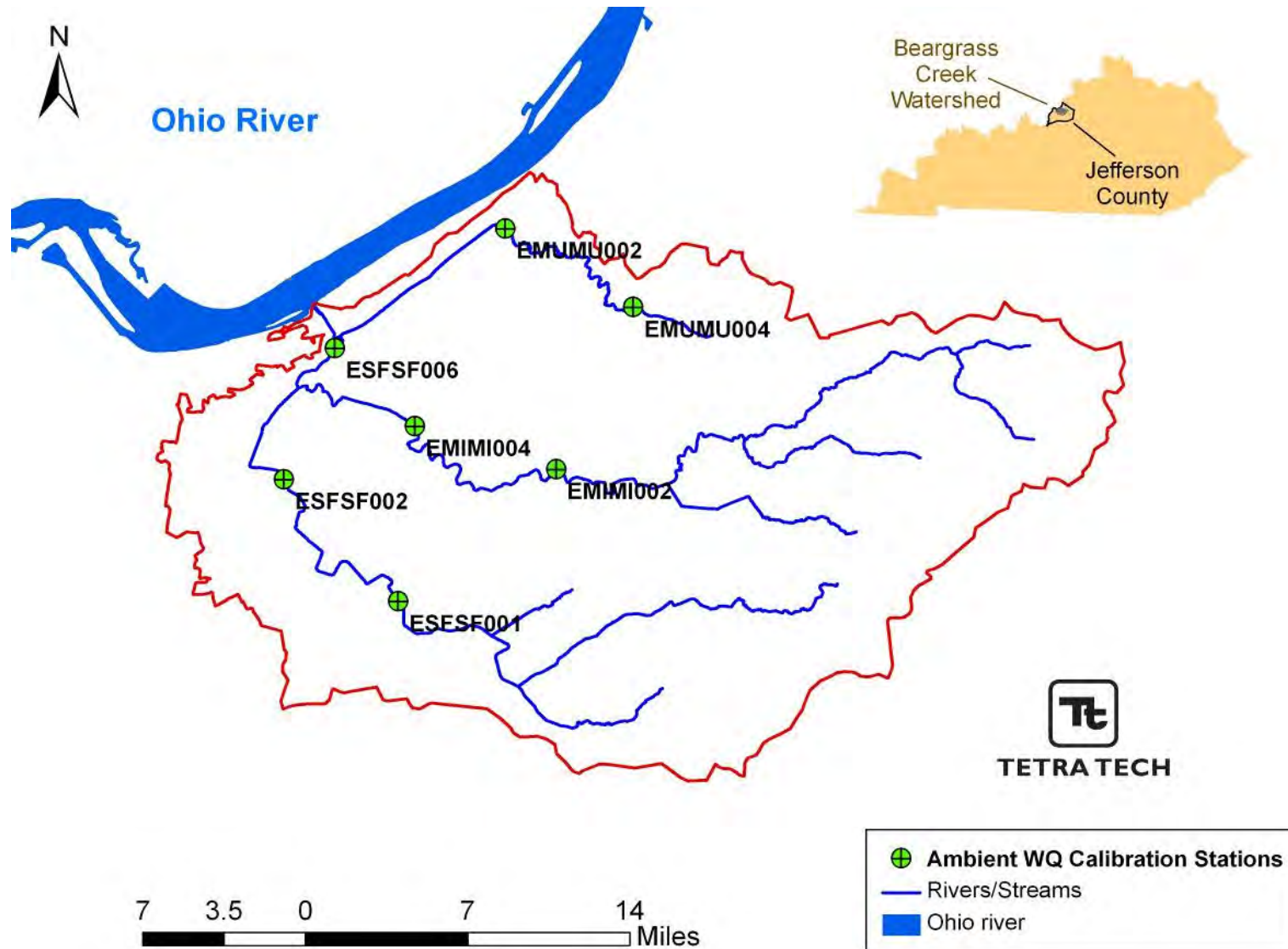


Figure 2.3 Continuous Water Quality Monitoring Sites in Beargrass Creek Watershed (Tetra Tech, et al., 2007)

## **2.4 Discrete Water Quality Sampling**

Continuous water quality monitoring is supplemented with discrete sampling to determine fecal coliform levels during the recreational contact season at all LTMN sites. This includes the five sites within the Beargrass Creek watershed. Fecal coliform is sampled five times per month from May 1 through October 31. Depending on the dates scheduled for sampling, the weather may be either wet or dry.

Currently, macroinvertebrates and fish are sampled bi-annually at each LTMN stream site, weather-permitting. Algae are sampled annually with a frequency of every three days throughout the critical dissolved oxygen period and habitat evaluations are conducted for each LTMN stream monitoring location.

Finally, CSOs, SSOs, stormwater runoff and in-stream flows are sampled during wet weather sampling events. Point sources, stormwater runoff and in-stream locations are all sampled and monitored for fecal coliform, total phosphorus, total nitrogen, total suspended solids, biological oxygen demand, instantaneous flow, temperature, specific conductivity, pH and dissolved oxygen during these wet weather events. Figure 2.4 illustrates all of the discrete water quality sampling locations.

In order to characterize the sources and constituents of stormwater pollution, stormwater sampling has been conducted at 20 sites throughout Jefferson County, including eight stormwater sample sites located within Beargrass Creek. The intent of the stormwater sampling is to determine and characterize the pollutants that come off various combinations of land use, slope, soil and imperviousness. Point sources which include CSOs and SSOs have also been sampled during wet weather events and the current sampling plan includes eight CSO locations and five SSO locations within the Beargrass Creek watershed. To characterize the direct impact of point and nonpoint source pollutant loadings on the water quality of the streams, 24 in-stream sites distributed throughout the three sub-watersheds are also sampled during a wet weather event. In-stream samples are taken at the head waters, above and below the sanitary and combined sewer system boundaries, and downstream of the mixing zones for point sources.

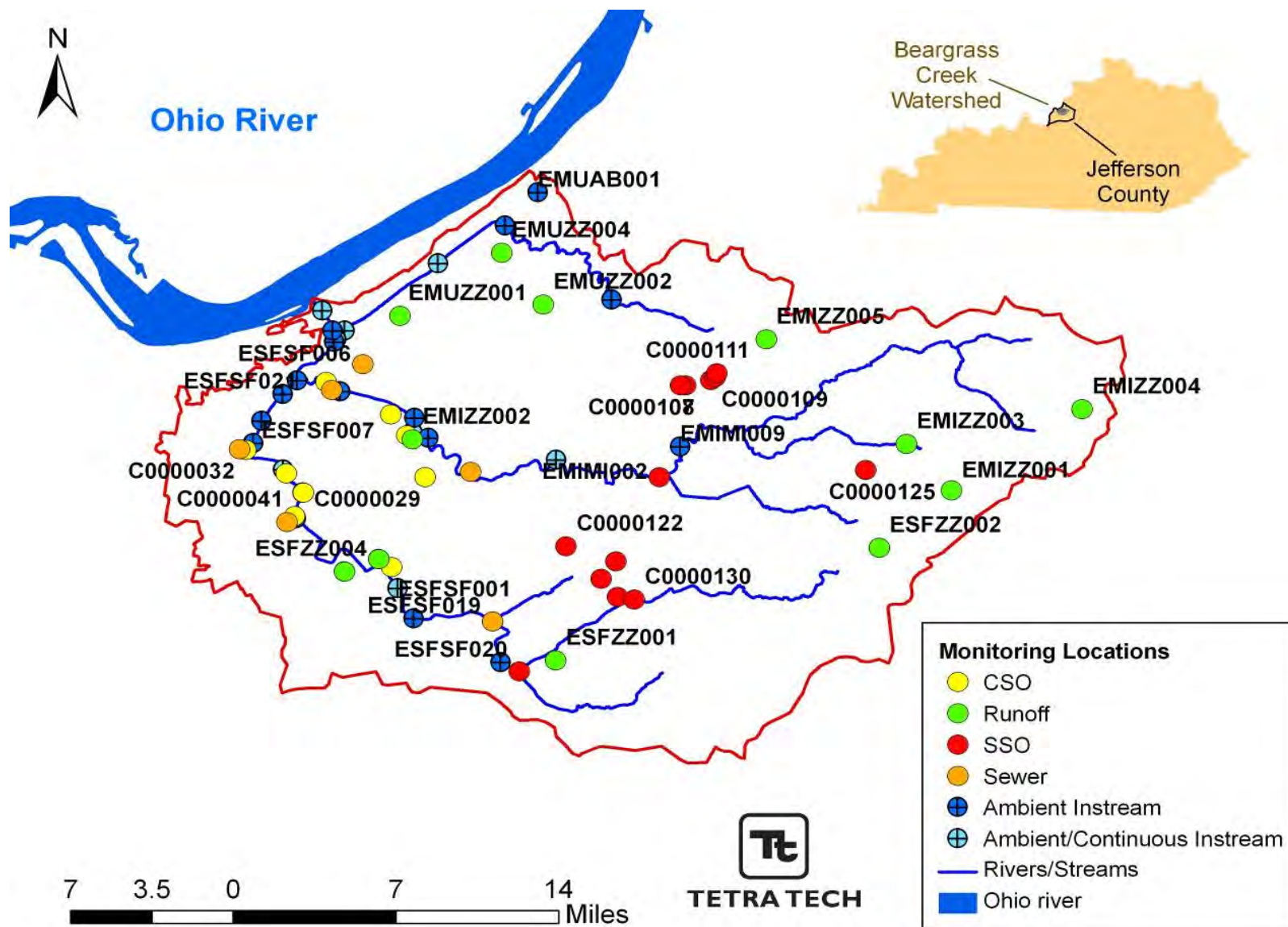


Figure 2.4 Discrete Water Quality Sampling Locations (Tetra Tech, et al., 2007)

## **2.5 CSO and SSO Flow Monitoring**

Both flow and pollutant concentrations are needed to generate loads. Historical flow monitoring data from point sources has been used to supplement water quality sampling and continuous water quality monitoring where data gaps existed. In the early 1990s, over 50 flow monitoring stations were installed throughout the combined system to gather flow measurements in the sewer lines, under a variety of dry weather and wet weather conditions. In 2003, MSD monitored an additional twelve CSO locations.

Although sporadic, SSO flow monitoring, sanitary sewer evaluation studies (SSES), and sewer rehabilitation projects were also conducted in the past. SSO flow monitoring was conducted from 1998 through 2003. This began with the advent of a centralized I/I program in 1998, when systematic evaluation of the sanitary sewer infrastructure and rehabilitation construction began.

## **2.6 Monitoring Results**

A significant amount of fecal coliform data has been collected in each of the tributaries of Beargrass Creek since 2000. These data are summarized in Appendix A as both composite time series data and through the use of load duration curves. The data reveal that each of the tributaries of Beargrass Creek is adversely affected by pathogens as measured by fecal coliforms.

### **3.0 PROBLEM DEFINITION**

#### **3.1 Impairments**

Waterborne pathogens are disease-causing bacteria, viruses, and protozoa. When people consume contaminated water, these pathogens can be transmitted resulting in severe problems of the digestive system, which can be life-threatening to the very young, very old, or those with compromised immune systems. To determine the risks to human health, the KDOW uses fecal coliform as an indicator organism of the possible presence of harmful bacteria and pathogens since fecal coliform bacteria have similar sources to other dangerous waterborne pathogens. They indicate that there are mammal or bird feces in the water and are measured to determine the relative risk of swimming (contact recreation).

The KDOW's 2010 303(d) report lists 35.8 miles of stream segments in the Beargrass Creek watershed as not supporting the designated use of primary contact recreation (swimming) due to fecal coliform impairment. The impaired segments are illustrated in Figure 3.1. These segments include the 13.6, 15.3 and 6.9 mile reaches of the South Fork, Middle Fork and Muddy Fork of Beargrass Creek, respectively. As a consequence of water quality impairment, a formal study is required which will identify the TMDL of fecal coliforms that Beargrass Creek and its forks can receive without violating the water quality standard for primary contact recreation. As prescribed by the Clean Water Act, when the existing load exceeds the TMDL, a load reduction strategy must be developed along with an implementation plan.

#### **3.2 Causes**

There are a number of reasons a stream segment may be impaired by fecal coliforms. Bacteria originate from the wastes of warm-blooded animals and their presence indicates that pathogens from these wastes may be reaching a body of water. The source of the waste could be from inadequately treated sewage, improperly managed animal waste from livestock, pets in urban areas, aquatic birds and mammals, or failing septic systems. The sources of these fecal coliform loadings, from a regulatory perspective, are typically classified into point and nonpoint sources and permitted or non-permitted sources.



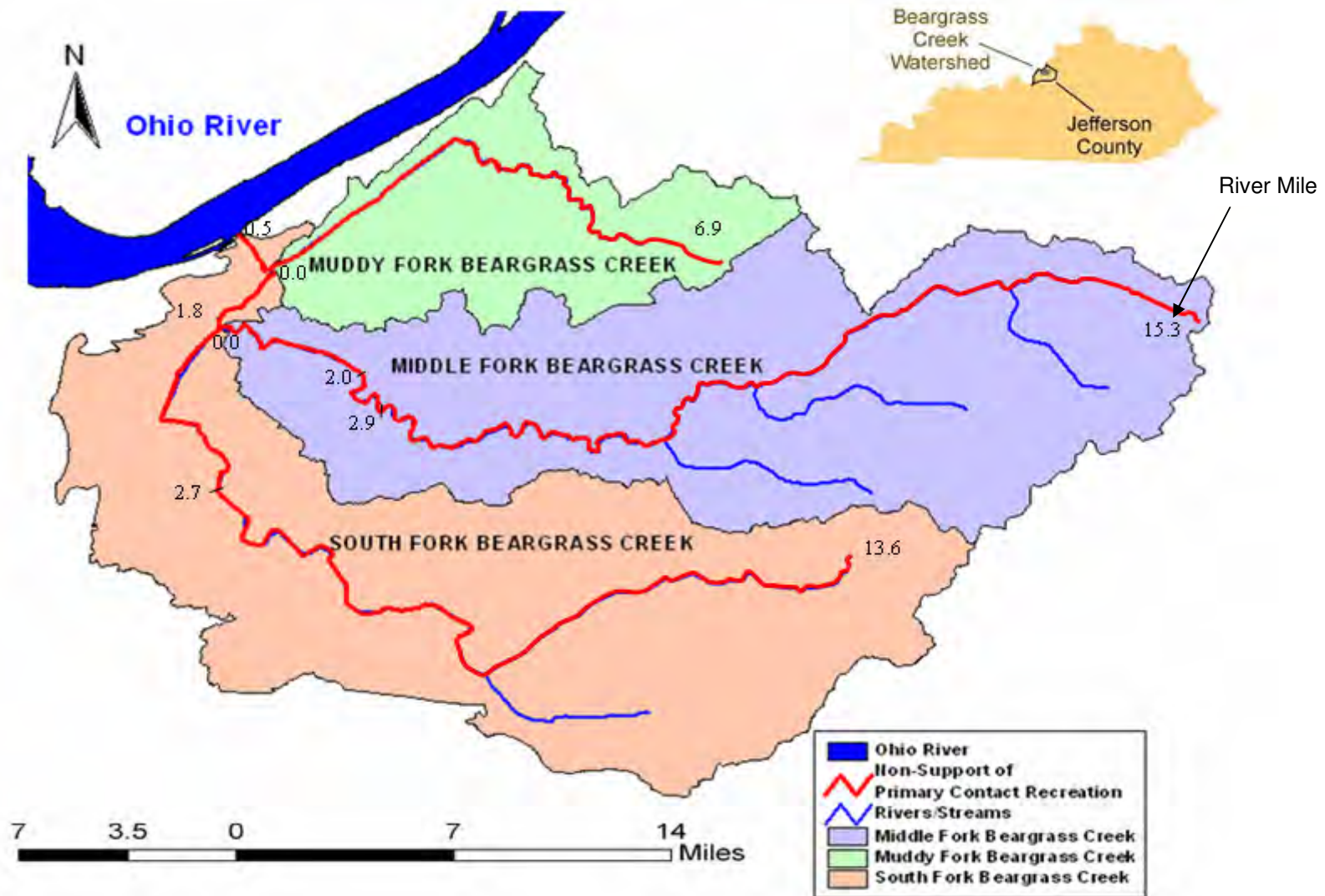


Figure 3.1 Impaired Stream Segments and Stream Miles in the Beargrass Creek Watershed (Developed using data from KDOW, 2008; and base map from LOJIC, 2007)

Point sources are normally related to end-of-pipe and direct discharges to surface waters such as CSOs and SSOs. Combined and sanitary sewer overflows that discharge inadequately treated sewage and diluted wastewater into the receiving waters result in high fecal coliform levels in the receiving waters. The Beargrass Creek watershed has had over 250 documented SSOs and has 57 permitted CSO locations. These point sources are considered one of the main causes of impairment due to fecal coliforms. Due to the deterioration related to the age of the infrastructure, the sewer lines and interceptors are failing and it is suspected that fecal coliforms are being introduced to the groundwater along the path of the failing pipes. The situation is exacerbated by the fact that all the main interceptors were constructed along and within each of the main branches of Beargrass Creek. Thus, groundwater contaminated by exfiltration from sewer lines can also cause impairment of the receiving waters.

Fecal coliforms are also introduced by more diffuse, nonpoint sources. Stormwater runoff from the watershed can elevate fecal coliform levels in the receiving waters by carrying domestic and wild animal wastes in the runoff. In addition, failing septic systems contaminate the groundwater which carries fecal coliforms to the receiving waters. Although most of the failing septic systems have been eliminated in the Louisville Metropolitan Area, some may remain. Finally, unknown straight pipes can contribute to the loading of fecal coliforms in receiving waters. Any of these are possible sources of the fecal coliform loading to Beargrass Creek.

### 3.3 Target Identification

The goal of the TMDL process is to achieve a numeric fecal coliform loading within the assimilative capacity of the impaired creek under study that allows for primary recreation contact (swimming). The KDOW currently uses fecal coliform as an indicator of the likelihood of pathogen impairment. The water quality standard for fecal coliform is tied to a specific designated use of primary recreational contact which is enforced from May 1 through October 31. For this designated use, the water quality standard requires that:

*Fecal coliform shall not exceed 200 colonies per 100 ml as a monthly geometric mean based on not less than 5 samples per month, nor exceed 400 colonies per 100 ml in 20 percent or more of the samples taken during the month (Kentucky Administrative Regulations, 2008).*

Where the geometric mean (GM) of data series of n observations (i.e.  $y_1, y_2, y_3 \dots y_n$ ) can be defined as:

$$GM = \sqrt[n]{y_1 \cdot y_2 \cdot y_3 \dots y_n}$$

Thus the in-stream fecal coliform target for this TMDL is a 30-day geometric mean of 200 colony counts per 100 ml or a maximum of 400 colonies per 100 ml or more for less than 20% of the time.

During the non-recreational season, from November 1 to April 30, secondary contact recreation is protected by the regulations which state that:



*Fecal coliform content shall not exceed 1000 colonies per 100 ml as a monthly geometric mean based on not less than five (5) samples per month; nor exceed 2000 colonies per 100 ml in twenty (20) percent or more of all samples taken during the month.(Kentucky Administrative Regulations, 2008)*

### **3.4 Water Quality Assessment**

A graphical assessment of the water quality conditions in each of the tributaries of Beargrass Creek can be obtained by plotting the observed fecal coliform data time series and superimposing the associated water quality standard. Associated fecal coliform plots for all three of the major sub-basins of Beargrass Creek for the period 2000-2005 are provided in Figures A.1 through A.3 in Appendix A. These figures reveal that each stream has a number of daily water quality violations that is in excess of the water quality standard.

An alternative way to evaluate the water quality conditions in a stream is to develop load duration curves for each ambient water quality station. Load duration curves are constructed by ranking the flows (from highest to lowest) associated with each fecal coliform observation along the horizontal axis and then plotting the associated mass of fecal coliforms obtained by multiplying the observed discharge with the associated fecal coliform concentration. By superimposing a load curve associated with either the recreational or non-recreational periods on a line reflective of the water quality standard, one can readily observe the level of water quality violations associated with a given station. Load duration curves for each of the sub-basins are provided in Figures A.4 through A.9 in Appendix A. Each stream has numerous violations (Appendix A).

## 4.0 SOURCE ASSESSMENT

Figure 4.1 illustrates the locations of the point sources (i.e. CSOs and SSOs), in the Beargrass Creek watershed, as well as the land use of the watershed related to nonpoint sources (i.e. stormwater). Assessments of both types of sources are provided in the following sections.

### 4.1 Assessment of Point Sources

There are 57 active permitted Kentucky Pollution Discharge Elimination System (KPDES) CSO discharges in the Beargrass Creek watershed (see Figure 4.1). All are located in either the Middle or South Fork sub-watersheds. These CSOs are associated with the KPDES permit # KY0022411 for the Morris Forman Wastewater Treatment Plant in Louisville, KY. Based on the information available in the KPDES permit, the number of overflows that occur each year, the average duration of each overflow, and the average volume per incident for each of the permitted CSOs are shown in Table 4.1.

In addition to these KPDES permits, the watershed also contains four additional KPDES permits as summarized in Table 4.2 and shown in Figure 4.2. In the absence of extensive data sets for these sites, an assumption was made that each of these sites is operating at its permitted wasteload (i.e. permitted discharge\*200 cfu/100 ml).

Some of the observed fecal coliforms may also originate from the numerous un-permitted SSOs. Each of the three creeks in Beargrass Creek Watershed can receive SSO discharges, however, the number of SSOs that discharge is highly contingent upon intensity and duration of rainfall as well as MSD's response to the overflows such as the pumping location, pump rate settings and run times. Sanitary sewer overflows are illegal and receive a wasteload allocation of zero.

The pipes that flow between and to the discharge point, many times run parallel or within the channel of the receiving water. The aging infrastructure may no longer be structurally sound and cracked underground sewer pipes can receive infiltration from groundwater, particularly when groundwater levels are higher during and after wet weather events. During drier periods when the groundwater recedes, the cracked pipes can leak sewage into the groundwater which ultimately flows to the receiving waters. Thus, infiltration and exfiltration from the pipes connected to the overflow locations add to the fecal coliform loadings in the receiving waters during both wet weather and dry weather.

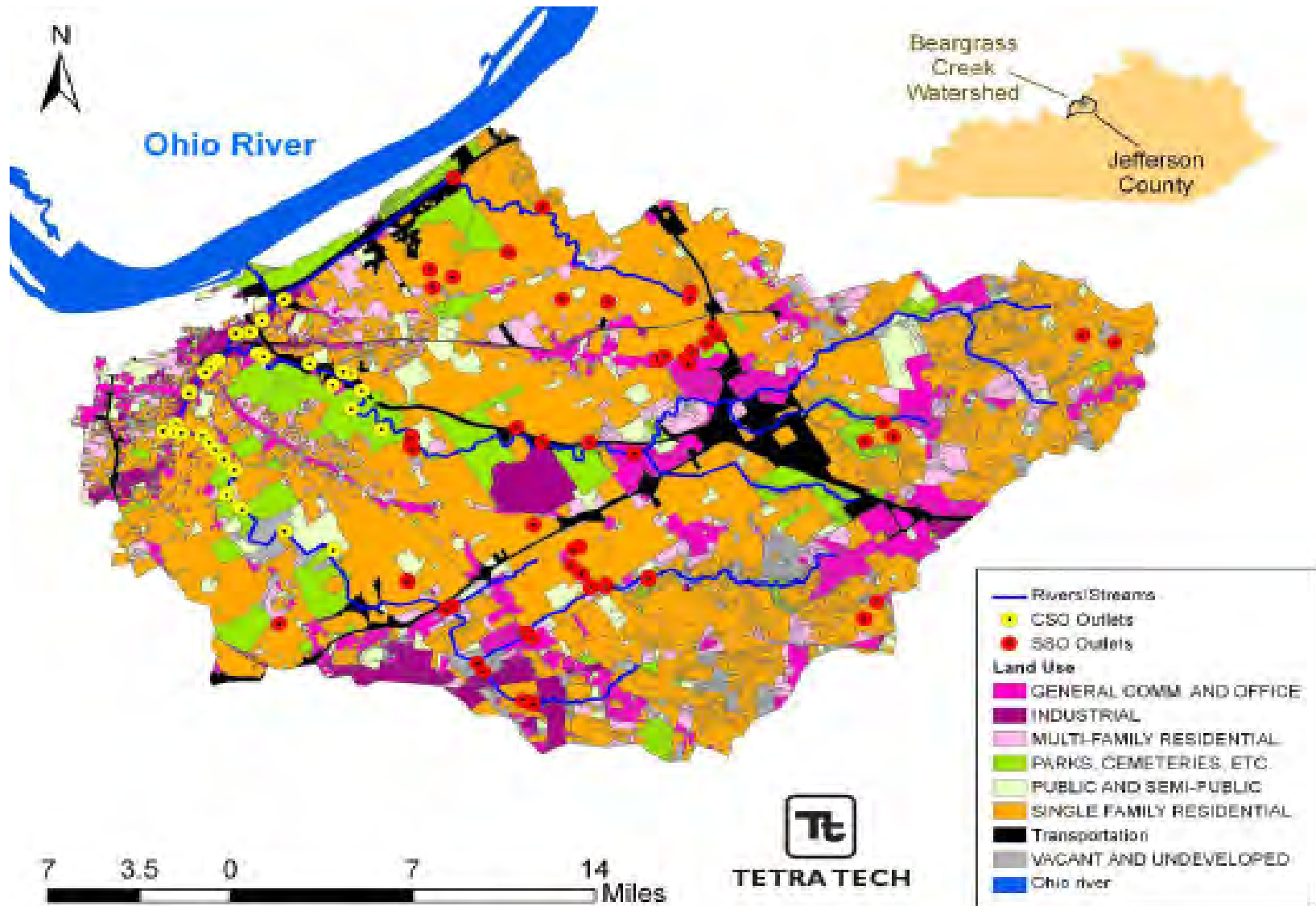


Figure 4.1 Locations of CSOs, Documented SSOs and Land Use Distribution (Tetra Tech, et al., 2007)

**Table 4.1 Inventory of Permitted CSOs in the Beargrass Creek Watershed  
(KDOW, 1999)\***

<b>CSO #</b>	<b>Sub-Basin</b>	<b>Overflows per Year (#/yr)</b>	<b>Avg. Duration of Overflow (hours)</b>	<b>Avg. Volume per Incident (1000 gal)</b>
018	400	1	29.00	640
081	790	0	0.00	0
082	790	12	1.25	40
083	620	36	1.86	70
084	620	15	1.20	140
086	780	0	0.00	0
087	790	0	0.00	0
088	790	0	0.00	0
091	500	3	1.33	20
092	500	2	1.00	15
093	790	0	0.00	0
097	410	56	6.98	880
106	410	11	1.09	10
108	390	34	2.17	1,160
109	400	19	1.15	150
110	410	32	1.90	120
111	500	39	2.74	240
113	500	46	5.13	170
117	610	37	3.02	2,230
118	600	64	7.29	2,650
119	600	27	1.62	80
120	600	24	1.50	180
121	600	23	1.39	130
125	765	30	7.16	610
126	765	6	1.16	40
127	765	29	1.86	450
130	790	26	3.53	250
131	790	3	1.33	70
132	790	64	6.62	1,830
137	410	19	1.63	50
140	780	28	1.92	180
141	600	0	0.00	0
142	610	N/A	N/A	N/A
144	770	27	3.70	20
146	610	51	6.72	1,790
147	620	65	3.10	20
148	500	12	1.16	20
149	610	19	8.26	360
151	500	64	7.40	2,240
152	500	42	2.88	810
153	790	53	3.37	130
154	790	12	1.33	120
166	760	31	1.83	520
167	790	0	0.00	0

**Table 4.1 Inventory of Permitted CSOs in the  
Beargrass Creek Watershed (continued)\***

CSO #	Sub-Basin	Overflows per Year (#/yr)	Avg. Duration of Overflow (hours)	Avg. Volume per Incident (1,000 gal)
174	610	18	1.20	110
179	610	14	1.21	8
180	610	0	0.00	0
182	610	38	2.00	290
183	610	0	0.00	0
184	610	14	1.21	20
185	610	23	1.34	50
186	610	0	0.00	0
187	610	0	0.00	0
188	610	0	0.00	0
205	610	0	0.00	0
206	755	63	10.50	1,410
209	760	53	2.90	90

\*Since the initiation of this study in 2003, MSD has reported closing the following CSOs: 81, 87, 88, 147, 145, and 209 (EPA, 2008).

**Table 4.2 TMDL (Wasteload Allocations) Associated with KPDES Sites**

KPDES Permit	Description	Subwatershed	Permitted Discharge (MGD)	TMDL (cfu/day)
KY0057061	Louisville Zoo: Outfall 001 Outfall 002	300	4.6	1.27E+13
KYG400146	Residence	940	0.0005	1.38E+09
KYG400206	Residence	910	0.0005	1.38E+09
KYG400349	Residence	400	0.0005	1.38E+09

Note: Any expanding or future KPDES-permitted point source must meet permit limits based on the Water Quality Standards in 401 KAR 10:031.

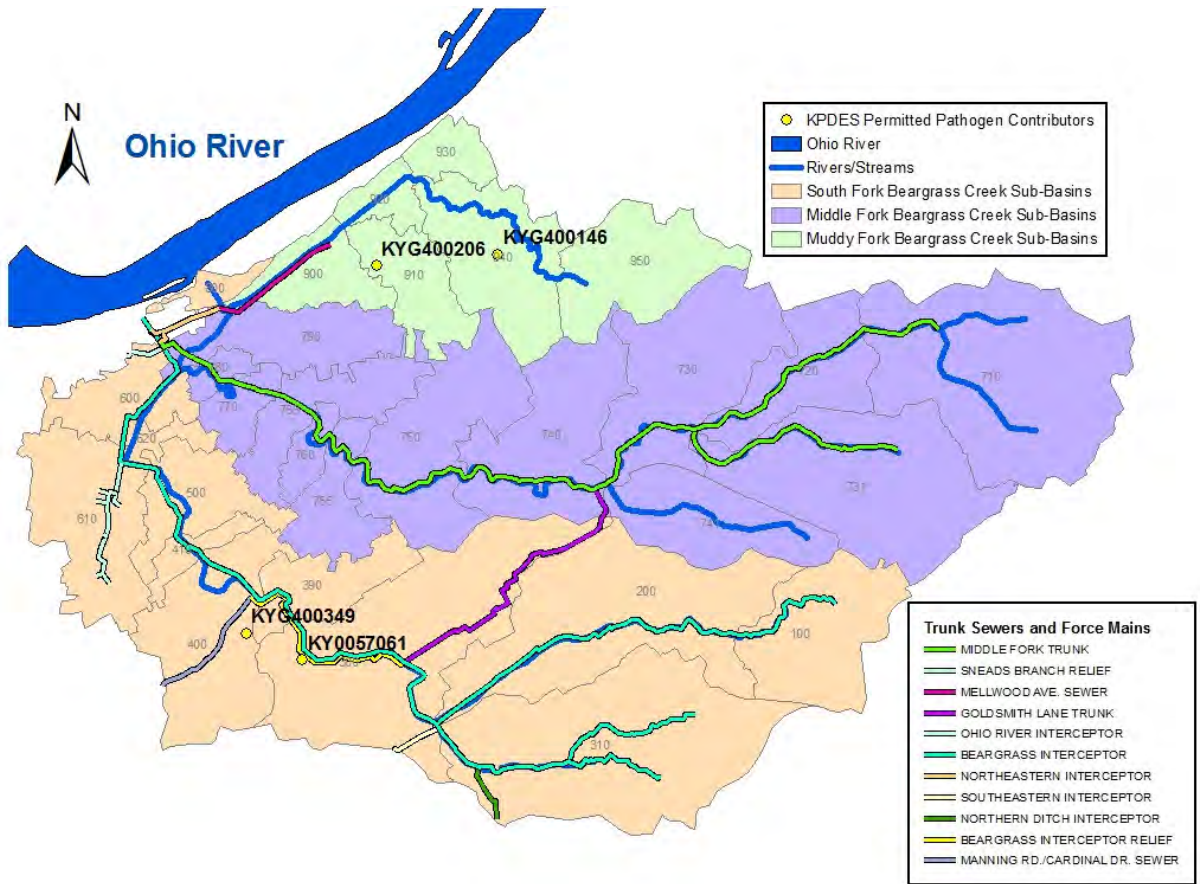


Figure 4.2 KPDES Permitted Fecal coliform Contributors

## 4.2 CSO Flow Contribution

CSOs provide a small, but important contribution to total flow during large rain events. At the USGS gage on South Fork Beargrass Creek at Winter Avenue (03292550), modeled CSOs accounted for 13.2 percent of the total modeled volume in stream during the 2000-2004 USEPA Stormwater Management Model (SWMM) application period. In order to assess the impact of CSO discharges on the total hydrograph, further analysis of the CSO contribution to both total flow and storm flow was made at the confluence of South and Middle Fork. To estimate direct surface runoff, a digital filter baseflow separation was applied to a model run without CSOs. Summary results are shown in the following table:

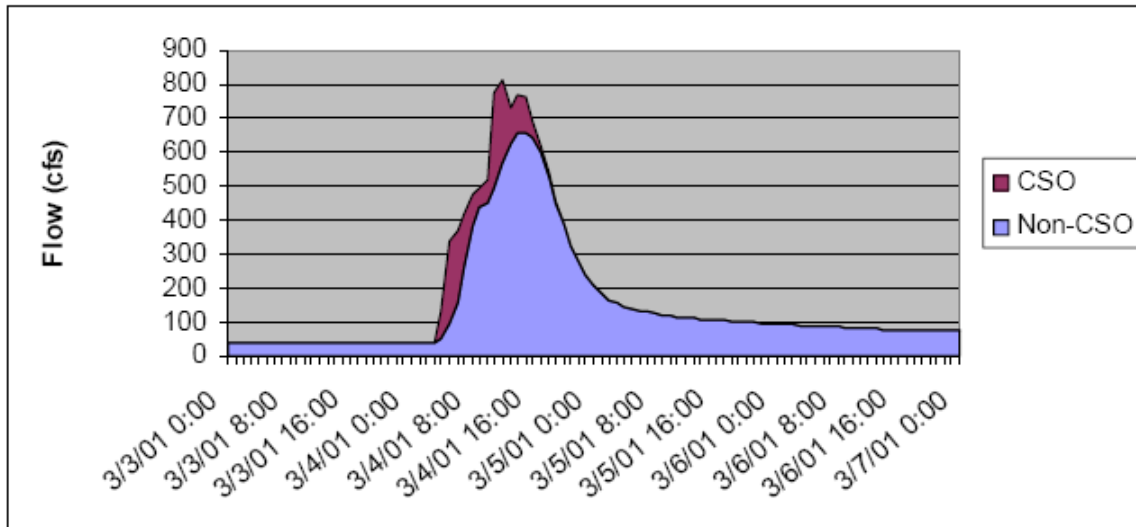
**Table 4.3 CSO Contribution to Total Flow, South and Middle Forks of Beargrass Creek (Tetra Tech, et al., 2007)**

	South Fork	Middle Fork	Sum
Baseflow (AF/yr)	15,174	16,098	31,272
Direct Runoff (AF/yr)	9,696	9,973	19,669
CSOs (AF/yr)	4,693	2,080	6,773
Total Flow (AF/yr)	29,563	28,151	57,715
CSO Percentage of Total	15.87%	7.39%	11.74%
CSO Percentage of Stormflow	32.61%	17.26%	25.61%

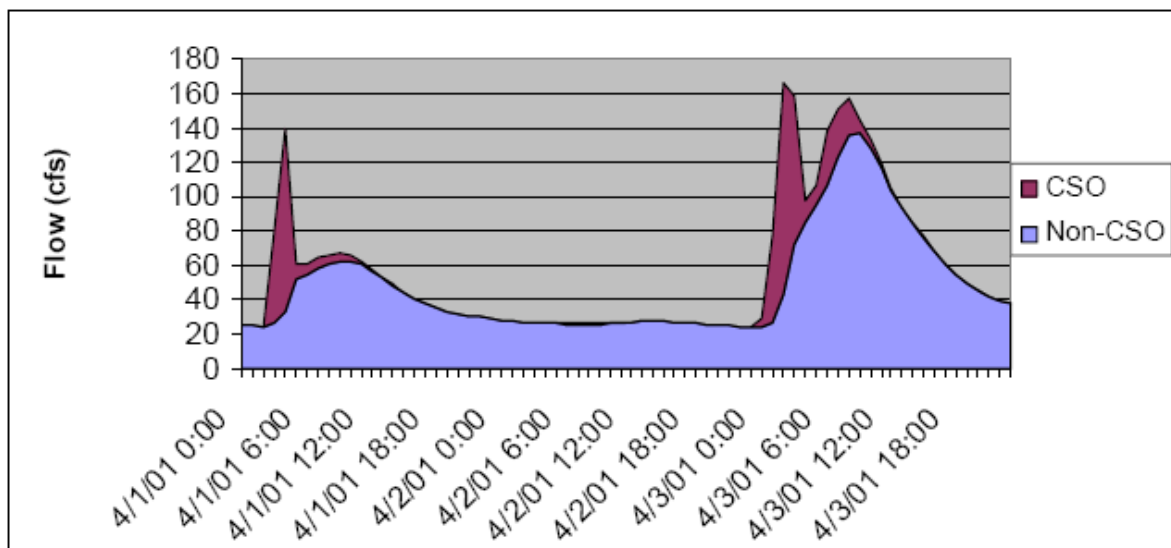
\* Note: Stormflow equals direct runoff plus CSO discharge

Not surprisingly, the CSO contribution increases downstream and is larger for South Fork than for Middle Fork. The CSO contributions occur primarily during large rainfall events when the capacity of the combined sewer system is exceeded. The combined sewer service area is downstream of the separate storm sewer area. The CSO hydrograph tends to arrive first, and can predominate on the rising limb of the storm hydrograph at downstream locations. This phenomenon is evident in hydrographs for two events in the Spring of 2001, specifically, one large event on March 4-5 (Figure 4.3) and a pair of moderate events on April 1 and 3, 2001 (Figure 4.4).

The mixing ratio (fraction of flow due to CSOs) can change very rapidly during a storm event and during the start of some events is greater than 96 percent in the South Fork. Rapid changes in the mixing ratio over a period of a few hours cause rapid changes in the in-stream concentrations of fecal coliform and other pollutants – which emphasizes some of the difficulty in characterizing in-stream concentrations from one or a few grab samples. The mixing ratio can be very high at the start of the hydrograph for even small runoff events. The high mixing ratio at the start of events plays an important role in causing excursions of water quality standards. Relative to CSO control, this pattern suggests that increases in storage volume that are less than needed to fully eliminate CSOs, but sufficient to delay overflows until later in the storm hydrograph, might have a significant benefit in reducing the frequency of water quality standard excursions. The allowable CSO loading receives an allocation under the wasteload.



**Figure 4.3 CSO and Non-CSO Contributions to Flow at Confluence of South and Middle Fork during Large Runoff Event of March 4-5, 2001 (Tetra Tech, et al., 2007)**



**Figure 4.4 CSO and Non-CSO Contributions to Flow at Confluence of South and Middle Fork during Moderate Runoff Events of April 1 and April 3, 2001 (Tetra Tech, et al., 2007)**

### 4.3 Assessment of Nonpoint Sources

There are many potential nonpoint sources of fecal coliform bacteria for Beargrass Creek, including:

- Failing septic systems,
- Straight pipes,
- Wildlife (deer, waterfowl etc), and
- Urban development (including domestic animals).



The flows from these diffuse sources are introduced to surface waters either through contaminated groundwater, runoff going directly into the receiving waters, or from storm drains that carry overland flows to stormwater discharge points. In-stream concentrations may be elevated by these sources but were not explicitly included in the model (e.g., illicit discharges, water fowl, wildlife) since the contribution of each of these individual nonpoint sources could not easily be quantified. As a result, concentration and flow information based on literature searches and MSD sampling data of runoff for various land uses were used. This information captured the combined input from each of the above sources based on land use and average loads from the land surface were generated based on buildup/washoff processes and concentrations assigned to individual land uses. Because Beargrass Creek is contained within the Louisville MS4 area, some contributions from these sources are permitted under numbers KYS000001 and KYS000003 and are allocated in the MS4 wasteload.

#### **4.4 Groundwater Contributions**

For the purposes of this TMDL, it is assumed that the groundwater source of fecal coliforms is associated with failing sewer lines, surface water sources that have migrated into the groundwater, or septic systems that may not have been properly retired. Failing sewer line sources are ultimately related to a permitted source (the Morris Forman Wastewater Treatment Plant) and are illegal, thus they receive a wasteload allocation of zero. The surface water sources that have migrated to groundwater and septic system sources receive an allowable load under the load allocation; however failing septic systems are illegal and should be removed or replaced to be properly functioning.

## 5.0 MODELING PROCEDURE: LINKING THE SOURCES TO THE ENDPOINT

The term TMDL is used to describe the maximum amount of a pollutant a stream can assimilate without violating water quality standards. The units of a load measurement are typically mass of pollutant per unit time (i.e. mg/hr, lbs/day). In the case of fecal coliforms, the load is expressed in terms of cfu/day. TMDLs are comprised of the sum of individual wasteload allocations (WLAs) which are typically associated with point or KPDES-permitted sources, and load allocations (LAs) which are typically associated with non permitted (no KPDES permit) nonpoint sources. For those cases where the nonpoint source loads occur within a municipal separate storm sewer system (MS4) permitted area, the associated loads are allocated to the WLA as opposed to the LA, because it is a KPDES-permitted source. The sum of the total loads from all sources may not result in an exceedance of water quality standards (WQSs) for that watershed. In addition, the TMDL must include a margin of safety (MOS), which is either implicit or explicit, that accounts for the uncertainty in the relation between pollutant loads and the quality of the receiving waterbody. Conceptually, the total TMDL may be expressed as follows:

$$\text{TMDL} = \Sigma (\text{WLAs}) + \Sigma (\text{LAs}) + \text{MOS}$$

Establishing the relationship between the in-stream water quality target and the source loading is a critical component of TMDL development and it allows for the evaluation of management options to achieve the desired source load reductions. The link can be established through a range of techniques, from qualitative assumptions to sophisticated modeling techniques. Ideally, the linkage will be supported by monitoring data that allow the TMDL developer to associate certain waterbody responses to flow and loading conditions. In this section, the selection of the modeling tools, setup, and model application are discussed.

### 5.1 Margin of Safety

For this TMDL, the margin of safety (MOS) is incorporated implicitly by using more conservative thresholds for the fecal coliform excursions (i.e. maximum criterion < 20%), and by calculating the simulated excursions using a 30 minute time step as opposed to a hourly or daily time step (USEPA, 2007). In addition, the model has been calibrated to slightly over predict the observed fecal coliform values in order to provide more conservative load reduction levels.

### 5.2 Modeling Framework Selection

USEPA guidance (2001) allows TMDLs to be based on either steady state or dynamic water quality models. Steady state models provide predictions for only a single set of environmental conditions. For permitting purposes, steady-state models are applicable for a single "critical" environmental condition that represents an extremely low assimilative capacity. For discharges to riverine systems, critical environmental conditions typically correspond to low flows such as the 7Q10. The assumption behind steady state modeling is that permit limits that are protective of water quality during critical conditions will be protective for the large majority of

environmental conditions. However, it is not appropriate to attempt to define a single critical stream flow for wet weather problems that is analogous to the critical (low flow) condition traditionally used with continuous point source discharges. Furthermore, even when continuous simulation is used for point source discharges, the appropriate method of analysis is to examine the model-generated data (receiving water concentrations) in terms of frequency and duration rather than examining concentrations at a single critical flow.

Continuous simulation often generates daily or hourly values of stream flow and pollutant concentrations. With a well-calibrated model, the simulated stream flows and pollutant concentrations are representative of real-world conditions. Continuous simulation, as well as other dynamic modeling approaches, explicitly consider the variability in all model inputs and define effluent limits in compliance with the associated WQS. This is achieved through selecting a critical period for which load allocations create the most stressful situation. The critical period for TMDL development corresponds to the “worst case” scenario of environmental conditions in the waterbody in which the TMDL for the pollutant will continue to satisfy the WQS (USEPA, 2001).

### **5.3 Model Selection**

In order to model the origin and transport of fecal coliforms through a stream system, some type of hydrologic model is needed. In the current study, a comprehensive Water Quality Tool (WQT) was used. A Hydrologic Simulation Program Fortran (HSPF: Bicknell, et. al, 2001) model of the hydrology of Beargrass Creek was originally created by USGS in the late 1990s (Jarrett et al., 1998). This model was updated by JE Edinger and Associates and an initial report on the updated model was provided to Louisville MSD in 2003 (Jarrett and Schaffer, 2003). At that point, the model hydrologic calibration was not satisfactory and the model was not fully developed or calibrated for effective simulation of water quality. Starting in 2003, Tetra Tech took over the existing HSPF model and this model was updated, refined, and combined with a model of the combined sewer system to create the Water Quality Tool. Additional modeling tools such as the CE-QUAL-RIV1 water quality model (RIV-1:Environmental Laboratory, 1995) and the Water Quality Analysis Simulation Program (WASP: Wool et al., 2003) were then added to address the complex hydrology in the areas of lower Beargrass Creek affected by backwater from the Ohio River. Numerous revisions have been made since 2003 to incorporate the variety of sources which may contribute to impairment and to improve the hydrologic and water quality simulation accuracy. Model development, calibration, and validation of the Beargrass Creek Water Quality Tool were carried out in accordance with a modeling Quality Assurance Project Plan (QAPP) (Tetra Tech, 2005). The final modeling QAPP was developed by Tetra Tech with consultation and oversight by the KWRRI. A detailed description of the WQT is provided in Appendix B.

In order to apply the WQT to the Beargrass Creek Watershed, the physical watershed must be represented in a conceptual framework. This will normally involve working with a physical or digital map of the watershed which is then subdivided into a set of sub-basins, each of which are then simulated in the computer model as distinct modeling units. The Beargrass Creek Watershed was subdivided into 31 sub-basins as shown in Figure 1.7. The computer simulation generated flows and fecal loadings for each of these sub-basins (taking into consideration both point and nonpoint loadings) which were then transported down through the channel and sewer

systems associated with each of the sub-basins until the flows and loads were discharged to Beargrass Creek. For the purposes of determining the TMDLs for each sub-watershed and evaluating the associated water quality standards, these 31 sub-basins were then aggregated into 11 larger sub-basins whose outlets corresponded to existing water quality monitoring stations (see Figure 2.3) or the physical outlet of a particular sub-watershed (i.e. Muddy Fork, Middle Fork, South Fork, and Beargrass Creek). A map showing the 11 reporting sub-basins is provided in Figure 5.1. A list of the 31 computational sub-basins that lie within the 11 reporting sub-basins is provided in Table 5.1.

**Table 5.1 Relationship between Computational and Reporting Sub-basins**

Sub-watershed	Reporting Sub-basin	Computational Sub-basins					
Mainstream	SMS000	C800					
	SSF006	C770					
Muddy Fork	SMU000	C900	C910	C920			
	SMU002	C930	C940				
	SMU004	C950					
Middle Fork	SM1000	C765	C770	C780			
	SM1004	C750	C755	C760			
	SM1002	C710	C720	C730	C731	C740	C741
South Fork	SSF000	C600	C610	C620			
	SSF002	C390	C400	C410	C500		
	SSF001	C100	C200	C300	C310		

#### 5.4 Model Calibration

Calibration is the process of adjusting model parameters to provide a match to observed conditions. Calibration is necessary because of the semi-empirical nature of water quality models. Although these models are formulated from mass balance principles, most of the kinetic descriptions in the models are empirically derived. These empirical derivations contain a number of coefficients that are usually determined by calibration to data collected in the waterbody of interest.

Calibration tunes the models to represent conditions appropriate to the waterbody and watershed under study. However, calibration alone is not sufficient to assess the predictive capability of the model or to determine whether the model developed via calibration contains a valid representation of cause and effect relationships. To help determine the adequacy of the calibration and to evaluate the uncertainty associated with the calibration, the model is subjected to a validation step. In the validation step, the model is applied to a set of data independent from that used in calibration and the model performance is then evaluated.

The Beargrass Creek Water Quality Tool consists of a series of linked models which need to be calibrated sequentially. First, the HSPF watershed model upstream of the combined sewer service area was calibrated to ensure good representation of the system in the absence of CSOs. The HSPF model provides input to the Stormwater Management Model (SWMM: Roesner et al., 1988) of the CSO system. SWMM-predicted CSO loadings are then brought back into the HSPF

model to complete calibration of the model upstream of the area of reversing flows in lower Beargrass Creek. HSPF and SWMM hydrology are then used to develop the RIV-1 model of lower Beargrass Creek. Finally, the RIV-1 model, in combination with boundary conditions provided by HSPF and SWMM, are used as input for the calibration of the Water Quality Analysis Simulation Program (WASP).

The calibration of the WQT was performed in two steps. First, the hydrologic parameters of the model were calibrated to meet observed CSO and in-stream discharges. Once the hydrologic parameters were calibrated and validated, the water quality parameters were then calibrated and validated. Details of the hydrologic calibration/validation are provided in Appendix C. Details of the water quality calibration/validation are provided in Appendix D. The final baseline loadings for each of the four major sources considered and for each of the sub-basins are provided in Table 5.2. The average annual loadings per stream segment are provided in Table 5.3.

**Table 5.2 Summary of Average Annual Loadings (cfu) per Sub-basin and Source Category**

SUB-WATERSHED	SUB-BASIN	Existing Loadings (cfu/yr) Total	Existing Wasteload (cfu/yr) SSO Sources	Existing Wasteload (cfu/yr) CSO Sources	Existing Wasteload (cfu/yr) MS4 Sources	Existing Wasteload (cfu/yr) KPDES Sources	Existing Wasteload and Load (cfu/yr) Groundwater Sources
<b>BEARGRASS</b>							
	SMS000	1.43E+13	0.00E+00	0.00E+00	1.33E+13	0.00E+00	9.73E+11
	SSF006	8.71E+14	0.00E+00	7.97E+14	6.44E+13	0.00E+00	8.81E+12
<b>MUDDY FORK BEARGRASS CREEK</b>							
	SMU000	6.04E+14	0.00E+00	0.00E+00	6.03E+14	1.38E+09	1.09E+12
	SMU002	7.82E+14	0.00E+00	0.00E+00	7.81E+14	1.38E+09	6.65E+11
	SMU004	6.08E+14	1.06E+07	0.00E+00	6.07E+14	0.00E+00	4.29E+11
<b>MIDDLE FORK BEARGRASS CREEK</b>							
	SMI000	5.55E+14	0.00E+00	3.67E+14	1.81E+14	0.00E+00	7.39E+12
	SMI004	1.15E+15	0.00E+00	6.74E+14	4.66E+14	0.00E+00	1.37E+13
	SMI002	4.89E+15	1.51E+09	0.00E+00	4.87E+15	0.00E+00	1.77E+13
<b>SOUTH FORK BEARGRASS CREEK</b>							
	SSF000	2.60E+15	1.77E+09	2.54E+15	5.22E+13	0.00E+00	1.56E+13
	SSF002	4.53E+15	7.56E+07	3.86E+15	6.53E+14	1.38E+09	1.64E+13
	SSF001	4.79E+15	1.59E+09	0.00E+00	4.77E+15	1.27E+13	6.63E+12
Total (cfu/yr)		2.14E+16	4.96E+09	8.24E+15	1.31E+16	1.27E+13	8.95E+13

The modeling QAPP (Tetra Tech, 2005) provides pre-specified targets for model calibration. These include quantitative statistical measures of model accuracy that represent an acceptable level of uncertainty in the model for application to its intended uses. The targets were specified prior to model development, so the ability to meet these targets was not guaranteed. The hydrologic targets for calibration are provided in Table 5.4. In general, most of these targets were met with the notable exception of Muddy Fork. This was largely due to perceived

problems with USGS gauging station 3293530, especially during periods of low flow. Detail results for each subbasin are provided in Appendix C.

**Table 5.3 Summary of Average Annual Loadings (cfu) per Stream Segment and Source Category**

SUB-WATERSHED	STATISTIC	Existing Loadings (cfu/yr) Total	Existing Wasteload (cfu/yr) SSO Sources	Existing Wasteload (cfu/yr) CSO Sources	Existing Wasteload (cfu/yr) MS4 Sources	Existing Wasteload (cfu/yr) KPDES Sources	Existing Wasteload and Load (cfu/yr) Groundwater Sources
<b>BEARGRASS CREEK MAINSTEM</b>							
River Mile 0.5 - 1.8	Average	8.85E+14	0.00E+00	7.97E+14	7.77E+13	0.00E+00	9.78E+12
<b>MUDDY FORK BEARGRASS CREEK</b>							
River Mile 0.0 – 6.9	Average	1.99E+15	1.05E+07	0.00E+00	1.99E+15	2.76E+09	2.16E+12
<b>MIDDLE FORK BEARGRASS CREEK</b>							
River Mile 0.0-15.3 (entire impaired reach)	Average	6.60E+15	1.51E+09	1.04E+15	5.52E+15	0.00E+00	3.89E+13
River Mile 0.0 - 2.0	Average	5.55E+14	0.00E+00	3.67E+14	1.81E+14	0.00E+00	7.39E+12
River Mile 2.0 – 2.9	Average	6.50E+14	0.00E+00	2.09E+14	4.32E+14	0.00E+00	9.65E+12
River Mile 2.9 – 15.3	Average	5.39E+15	1.51E+09	4.65E+14	4.91E+15	0.00E+00	2.18E+13
<b>SOUTH FORK BEARGRASS CREEK</b>							
River Mile 0.0 –13.6 (entire impaired reach)	Average	1.19E+16	3.44E+09	6.40E+15	5.48E+15	1.27E+13	3.87E+13
River Mile 0.0 – 2.7	Average	3.56E+15	1.78E+09	3.44E+15	8.84E+13	0.00E+00	2.28E+13
River Mile 2.7 – 13.6	Average	8.37E+15	1.66E+09	2.95E+15	5.39E+15	1.27E+13	1.59E+13

**Table 5.4 Relative Errors and Statistical Targets for Hydrologic Calibration**

Relative Errors (Simulated-Observed)	Statistical Target
<b>Error Targets for HSPF Models</b>	
Error in total volume	± 10%
Error in 50% lowest flows	± 10%
Error in 10% highest flows	± 15%
Error in 10% highest peak	± 15%
Seasonal volume error–Summer	± 20%
Seasonal volume error–Fall	± 20%
Seasonal volume error–Winter	± 20%
Seasonal volume error–Spring	± 20%
Error in storm volumes	± 20%
Error in summer storm volumes	± 20%
<b>SWMM Error Targets</b>	
CSO and SSO -Total system output error	±20%
CSO and SSO -Total overflow volume error	±20%

Three different targets were developed for fecal coliform calibration. The first criteria required that the model be able to reproduce 80% of the observed data in excess of 200 cfu/100 mL within 0.5 logs. The second criteria required that the model be able to reproduce 95% of the data within 1.0 logs. The third criteria required that the model be able to predict the total number of water quality excursions within 10 percent. Calibration and validation results are shown in Tables 5.5-5.7. While the first two calibration criteria were not consistently met for all conditions, the third criterion (for excursions) was generally satisfied. In those cases when it was not, this was generally due to over prediction of the excursions. Detailed results of the water quality calibration are provided in Appendix D.

As can be seen from the information in Appendix D and as summarized in Table 5.7, the model tends to slightly over predict the fecal coliform values for most of the monitoring stations. As discussed in section 5.1, this provides an additional implicit margin of safety for the final TMDLs as well as the associated load reductions.

**Table 5.5 Calibration and Validation Statistics for Fecal Coliform Bacteria (cfu/100 mL)**

Station		SF01	SF02	SF06	MI02	MI04	MU02	MU04
Sample Count (days)		166	166	74	136	11	110	112
Full Period (2000-2004)	Average error	-1773	-2182	-12808	-2975	-42266	319	-178
	Median error	32	0	0	29	-40	14	5
	Median absolute error	73	102	291	164	7893	49	50
Calibration (2000-2003)	Relative absolute error	1.33%	0.93%	2.37%	2.19%	11.8%	21.6%	8.15%
Validation (2004)	Relative absolute error	1.47%	0.74%	1.02%	2.24%	ND	6.70%	1.34%
Observations > 200/100 mL	Predicted within 0.5 log units	63.6%	84.3%	64.2%	78.9%	88.9%	71.3%	58.4%
	Predicted within 1.0 log units	78.2%	96.5%	91.4%	96.3%	100%	97.3%	79.2%

**Table 5.6 Prediction Statistics for Fecal Coliform Bacteria (cfu/100 mL) at Higher Flows**

Station		SF01	SF02	SF06	MI02	MI04	MU02	MU04
Flow Range		> 10 cfs	> 10 cfs	> 10 cfs	> 10 cfs	> 10 cfs	> 2 cfs	> 2 cfs
Observations > 200/100 L	Predicted within 0.5 log units	77.8%	90.3%	64.7%	77.9%	88.9%	92.8%	74.1%
	Predicted within 1.0 log units	91.9%	99.0%	92.6%	97.4%	100%	100%	81.3%

**Table 5.7 Prediction Statistics for Fecal Coliform Excursions**

	ESFSF001	ESFSF002	ESFSF006	EMIMI002	EMUMU002	EMUMU004
<i>Recreation Season Only</i>						
Model	28.1%	55.7%	81.1%	45.4%	30.8%	32.4%
Observed	32.7%	48.5%	60.8%	37.8%	16.7%	40.7%
<i>All Data</i>						
Model	25.7%	40.6%	58.0%	34.5%	26.5%	28.3%
Observed	33.5%	47.2%	53.1%	37.4%	8.3%	22.2%



## 5.5 Critical Period

The critical condition used for the modeling and evaluation of stream response was represented by a multi-year period because fecal coliforms may be attributable to both point and nonpoint sources (i.e. stormwater). Periods for use in calibrating the model are limited by the availability of data. The base meteorological data commence in 1993 and the last complete year is 2004, while the complex CSO model has been run only for 2000-2004 conditions. In addition, land use and management practices change over time, so use of water quality monitoring results from the early 1990s is likely inappropriate for calibration to current land use.

The HSPF model was run for the period 1/1/1993 – 12/21/2004. It is desirable to allow a period for model spin up and stabilization of internal stores because the model is affected by initial conditions. The hydrologic calibration was consequently based on the 5-year period 1/1/1995 – 12/31/1999, while hydrologic validation was based on the 5-year period 1/1/2000 – 12/31/2004.

The water quality calibration and validation were constrained to the period of 2000 to 2004 for which the SWMM model of CSOs is available. Because the 2004 ambient monitoring data were not provided until after calibration began, Tetra Tech chose to use 2000-2003 water quality data for calibration, and the 2004 water quality data for validation.

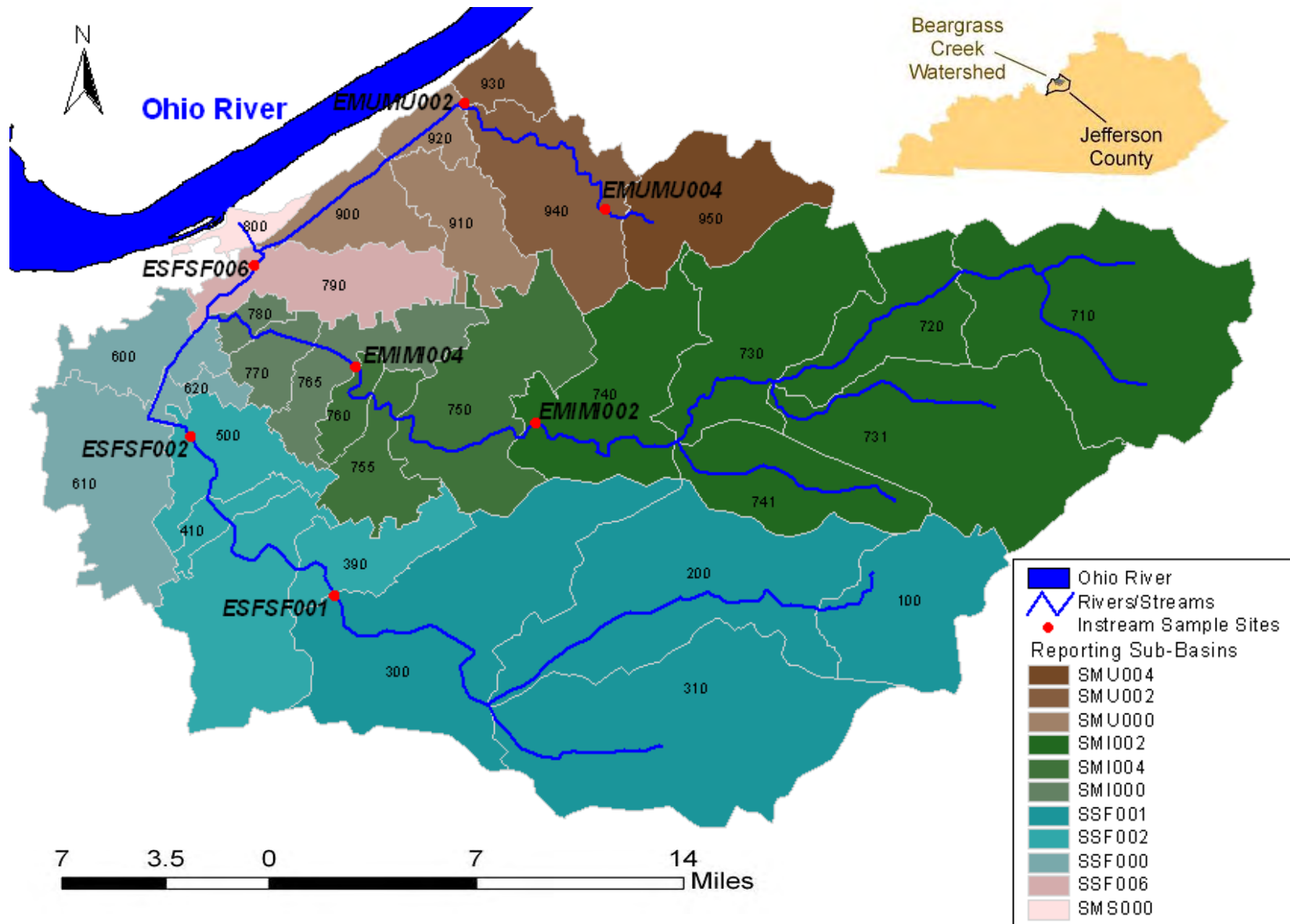


Figure 5.1 Sub-basin Grouping for Reporting Purposes (Developed using data from Tetra Tech, et al., 2007)

## 5.6 Model Application

Historical compliance with the maximum and average water quality standards for primary contact recreation can be evaluated by examining historical data sets (either represented as a time series or a load frequency curve) as discussed previously. Compliance in response to an associated water quality management strategy can be predicted using a mathematical model. In evaluating the adequacy of a particular load reduction strategy to meet the associated water quality standards (and hence the associated TMDL), a predicted time series of fecal coliforms can be generated and evaluated. If 80% of the predicted daily maximum values are found to be below the maximum standard of 400 cfu/100 ml (2000 cfu/100 ml in non-recreational period) then the stream is deemed to be in compliance and the associated load can then serve as a basis for the TMDL. The average criteria can be evaluated by generating a moving average 30 day geometric mean of fecal values which can be developed using predicted results from the simulation model as applied over the appropriate time frame (e.g. May to October for the primary contact period). If 100% of the geometric mean values within a 30 day period are found to be below the geometric mean standard of 200 cfu/100 ml (1000 cfu/100 ml in the non-recreational period), then the stream is deemed to be in compliance and the associated load can also serve as a basis for the TMDL. The final TMDL is associated with a loading that satisfies the maximum and average water quality conditions for both the recreational and non-recreational periods.

The WQT uses a 5 minute computational time step for generating the flows and associated load predictions for each of the 11 reporting sub-basins within the Beargrass Creek (Figure 5.1). For the purposes of determining compliance with the water quality standards, these 5 minute results were aggregated and then averaged over a 30 minute period. Compliance with the maximum and average fecal coliform standards was then evaluated (using this synthesized 30 minute time step time series) over the entire five year simulation period (with the appropriate standard used depending upon the particular month). The 30 day geomean criteria were thus evaluated using a moving average of 1440 values (i.e. 30 days multiplied by the 48-30 minute values within a day). The maximum criteria are also evaluated using the 30 minute aggregate values. Compliance with the maximum criteria is then determined by the percent of time over a day the 30 minute aggregate values exceed the water quality standard.

In the case where the 30-day averaging period crosses the boundary between winter and recreation season water quality standards it is not appropriate to compare the resulting geometric mean to either of the geometric mean criteria alone. Instead, a composite approach is used that employs the appropriate criterion pertaining to each of the days within an averaging period. The 30-day geometric mean may be calculated as

$$\exp\left(\frac{1}{30} \sum_{i=1}^{30} \ln C_i\right) = \prod_{i=1}^{30} \exp\left(\frac{\ln C_i}{30}\right),$$

where  $C_i$  is the concentration on day  $i$ . For the seasonal transition periods, the weighted 30-day ratio of the geometric mean to the standards for each day ( $S_i$ ) is evaluated as

$$\prod \frac{\exp\left(\frac{\ln C}{30}\right)}{S_i^{1/30}} = \frac{\text{Geomean } C}{\text{Geomean } S}$$

In other words, the calculated 30-day geometric means that encompass the shift between winter and recreation season standards are compared to the geometric mean of the water quality standard values for those days, providing an appropriate weighting across the transition period.

## 5.7 Model Results

Once the WQT was calibrated, the model was used to predict the fecal coliform values and associated compliance statistics at each of the 11 reporting sub-basins as identified in Table 5.1 and Figure 5.7. In addition to the baseline results, an additional simulation was conducted that evaluated the impact of removing 100% of both the SSOs and the CSOs. Results of these analyses are provided in Appendices E and F and summarized in Tables 5.8 and 5.9. Neither simulation satisfies either water quality criterion.

**Table 5.8 Frequency of Water Quality Excursions (Failures) for Baseline (Existing) Conditions**

Sub-basin	SSF001	SSF002	SSF000	SSF006	SMI002	SMI004	SMI000	SMU002	SMU004	SMU000	SMS000
<b>Geometric Mean Criterion (&lt; 200 cu/100 ml)</b>											
All data	34.5%	58.1%	67.2%	71.8%	54.4%	58.2%	59.9%	38.8%	40.6%	58.9%	81.0%
Winter	9.5%	24.4%	38.0%	45.1%	18.2%	23.4%	26.1%	5.2%	6.1%	30.3%	62.1%
Rec Season	59.2%	91.2%	96.0%	98.1%	90.2%	92.5%	93.2%	71.9%	74.7%	87.0%	99.6%
<b>Maximum Criterion (&lt; 400 cu/100 ml)</b>											
All data	25.7%	40.6%	48.0%	55.6%	34.5%	44.1%	42.7%	26.5%	28.3%	46.4%	63.2%
Winter	23.1%	24.9%	27.3%	33.1%	23.0%	24.8%	26.9%	22.1%	24.1%	31.3%	43.0%
Rec Season	28.1%	56.1%	68.5%	77.8%	45.9%	63.1%	58.3%	30.8%	32.5%	61.3%	83.0%

**Table 5.9 Frequency of Water Quality Excursions (Failures) for Baseline with all SSOs and CSOs Eliminated**

Sub-basin	SSF001	SSF002	SSF000	SSF006	SMI002	SMI004	SMI000	SMU002	SMU004	SMU000	SMS000
<b>Geometric Mean Criterion (&lt;200 cu/100 ml)</b>											
All data	34.6%	56.6%	64.2%	64.8%	54.4%	57.9%	59.2%	38.8%	40.6%	57.8%	71.1%
Winter	9.6%	22.4%	33.6%	35.2%	18.2%	23.2%	25.0%	5.2%	6.1%	26.3%	45.4%
Rec Season	59.3%	90.3%	94.4%	94.0%	90.2%	92.1%	93.0%	71.9%	74.7%	88.8%	96.5%
<b>Maximum Criterion (&lt;400 cu/100 ml)</b>											
All data	25.7%	39.2%	43.2%	0.0%	34.6%	43.8%	42.6%	26.5%	28.4%	43.0%	57.7%
Winter	23.2%	24.0%	25.8%	29.6%	23.0%	24.4%	26.3%	22.1%	24.1%	30.5%	38.5%
Rec Season	28.2%	54.2%	60.3%	68.8%	46.0%	63.0%	58.8%	30.9%	32.5%	55.2%	76.6%

## **6.0 TMDL, LOAD ALLOCATION, AND LOAD REDUCTIONS**

### **6.1 Load Reduction Strategies**

Based on the preliminary model results, the existing system will not satisfy the Kentucky primary contact recreation water quality standards even with the removal of all SSOs and CSOs. As a consequence, some type of additional load reduction strategy is necessary. Once the WQT model for Beargrass Creek was calibrated and validated, the associated point and nonpoint loads for each sub-basin were reduced until the in-stream water quality criteria were satisfied. The final loads resulting in compliance with the water quality standard (inclusive of the margin of safety) will constitute the TMDL for each sub-basin.

Two different potential management scenarios were investigated for meeting the water quality criteria and establishing the TMDL: 1) CSO storage/treatment along with associated nonpoint source (NPS) and groundwater reductions (including complete elimination of all SSOs), and 2) Sewer separation along with associated NPS and groundwater reductions (including complete elimination of all SSOs). Multiple computer analyses were performed for each scenario before a set of initial wasteload reductions was found that satisfied the water quality standards. A summary of the wasteload reduction values for each scenario are provided in Tables 6.1 - 6.4. The results of these analyses are provided in Appendices G and H and are summarized in Tables 6.5 and 6.6. It should be emphasized that although the two scenarios show potential examples of how the water quality standard might be obtained, future additional means or alternative strategies may be selected to meet the associated water quality targets in a more cost effective or practical manner.

It should be emphasized that the specific load and wasteload reductions scenarios considered by the TMDL may or may not be economically feasible or physically achievable with existing technologies or currently available best management practices. As a consequence, additional analyses may be required (e.g. through a Long Term Control Plan) in order to identify or refine such solutions. At a minimum, the TMDL does identify and quantify relative sources of impairment along with theoretical load and wasteload reductions that would be necessary to achieve water quality standards, and as such, provides a starting point for any future investigations or associated load or wasteload reduction projects.

**Table 6.1 Summary of Initial Loading Reductions for Scenario I: CSO  
Storage/Treatment per Subbasin and Source Category**

SUB-WATERSHED	SUB-BASIN	Average Annual Loading Reduction	WASTELOAD REDUCTION SSO sources	WASTELOAD REDUCTION CSO sources	WASTELOAD REDUCTION MS4 sources	WASTELOAD and LOAD REDUCTION Groundwater sources
<b>BEARGRASS</b>						
	SMS000	96%	100%	98%	95%	86%
	SSF006	96%	100%	98%	95%	87%
<b>MUDDY FORK BEARGRASS CREEK</b>						
	SMU000	95%	100%	NA	95%	40%
	SMU002	95%	100%	NA	95%	40%
	SMU004	95%	100%	NA	95%	40%
<b>MIDDLE FORK BEARGRASS CREEK</b>						
	SMI000	95%	100%	98%	95%	86%
	SMI004	95%	100%	98%	95%	84%
	SMI002	95%	100%	NA	95%	78%
<b>SOUTH FORK BEARGRASS CREEK</b>						
	SSF000	96%	100%	98%	95%	85%
	SSF002	96%	100%	98%	95%	77%
	SSF001	95%	100%	NA	95%	40%

**Table 6.2 Summary of Initial Loading Reductions for Scenario I: CSO  
Storage/Treatment per Stream Segment and Source Category**

SUB-WATERSHED RIVER MILE	STATISTIC	Average Annual Loading Reduction	WASTELOAD REDUCTION SSO sources	WASTELOAD REDUCTION CSO sources	WASTELOAD REDUCTION MS4 sources	WASTELOAD and LOAD REDUCTION Groundwater sources
<b>BEARGRASS CREEK MAINSTEM</b>						
River Mile 0.5 - 1.8	Maximum	96%	100%	98%	95%	86%
<b>MUDDY FORK BEARGRASS CREEK</b>						
River Mile 0.0 – 6.9	Maximum	95%	100%	NA	95%	40%
<b>MIDDLE FORK BEARGRASS CREEK</b>						
River Mile 0.0-15.3 (entire impaired reach)	Maximum	95%	100%	98%	95%	86%
River Mile 0.0 - 2.0	Maximum	95%	100%	98%	95%	86%
River Mile 2.0 – 2.9	Maximum	95%	100%	98%	95%	84%
River Mile 2.9 – 15.3	Maximum	95%	100%	98%	95%	81%
<b>SOUTH FORK BEARGRASS CREEK</b>						
River Mile 0.0 –13.6 (entire impaired reach)	Maximum	96%	100%	98%	95%	85%
River Mile 0.0 – 2.7	Maximum	96%	100%	98%	95%	85%
River Mile 2.7 – 13.6	Maximum	96%	100%	98%	95%	69%

**Table 6.3 Summary of Initial Loading Reductions for Scenario II: Sewer Separation per Subbasin and Source Category**

SUB-WATERSHED	SUB-BASIN	Average Annual Loading Reduction	WASTELOAD REDUCTION SSO sources	WASTELOAD REDUCTION CSO sources	WASTELOAD REDUCTION MS4 sources	WASTELOAD and LOAD REDUCTION Groundwater sources
<b>BEARGRASS</b>						
	SMS000	96%	100%	100%	94%	85%
	SSF006	96%	100%	100%	93%	87%
<b>MUDDY FORK BEARGRASS CREEK</b>						
	SMU000	95%	100%	NA	95%	40%
	SMU002	95%	100%	NA	95%	40%
	SMU004	95%	100%	NA	95%	40%
<b>MIDDLE FORK BEARGRASS CREEK</b>						
	SMI000	95%	100%	100%	94%	86%
	SMI004	95%	100%	100%	94%	84%
	SMI002	95%	100%	NA	95%	78%
<b>SOUTH FORK BEARGRASS CREEK</b>						
	SSF000	97%	100%	100%	93%	85%
	SSF002	97%	100%	100%	94%	77%
	SSF001	95%	100%	NA	95%	40%

**Table 6.4 Summary of Initial Loading Reductions for Scenario II: Sewer Separation per Stream Segment and Source Category**

SUB-WATERSHED RIVER MILE	STATISTIC	Average Annual Loading Reduction	WASTELOAD REDUCTION SSO sources	WASTELOAD REDUCTION CSO sources	WASTELOAD REDUCTION MS4 sources	WASTELOAD and LOAD REDUCTION Groundwater sources
<b>BEARGRASS CREEK MAINSTEM</b>						
River Mile 0.5 - 1.8	Maximum	96%	100%	100%	94%	85%
<b>MUDDY FORK BEARGRASS CREEK</b>						
River Mile 0.0 – 6.9	Maximum	95%	100%	NA	95%	40%
<b>MIDDLE FORK BEARGRASS CREEK</b>						
River Mile 0.0-15.3 (entire impaired reach)	Maximum	95%	100%	100%	94%	86%
River Mile 0.0 - 2.0	Maximum	95%	100%	100%	94%	86%
River Mile 2.0 – 2.9	Maximum	95%	100%	100%	94%	84%
River Mile 2.9 – 15.3	Maximum	95%	100%	100%	95%	81%
<b>SOUTH FORK BEARGRASS CREEK</b>						
River Mile 0.0 –13.6 (entire impaired reach)	Maximum	97%	100%	100%	93%	85%
River Mile 0.0 – 2.7	Maximum	97%	100%	100%	93%	85%
River Mile 2.7 – 13.6	Maximum	97%	100%	100%	96%	68%

**Table 6.5 Frequency of Water Quality Excursions for Scenario I**

Sub-basin	SSF001	SSF002	SSF000	SSF006	SMI002	SMI004	SMI000	SMU002	SMU004	SMU000	SMS000
<b>Geometric Mean Criterion</b>											
All data	0.0%	0.0%	0.1%	0.6%	0.0%	0.0%	0.0%	0.0%	0.0%	0.5%	4.8%
Winter	0.0%	0.0%	0.0%	0.0%	0.0%	0.0%	0.0%	0.0%	0.0%	0.3%	0.7%
Rec Season	0.0%	0.0%	0.1%	1.2%	0.0%	0.0%	0.0%	0.0%	0.0%	0.6%	8.8%
<b>Maximum Criterion</b>											
All data	6.8%	9.0%	9.4%	9.8%	6.5%	7.5%	7.7%	6.6%	7.1%	7.7%	9.6%
Winter	3.1%	5.3%	5.1%	2.8%	3.0%	3.2%	3.2%	3.5%	3.7%	2.4%	1.6%
Rec Season	10.4%	12.6%	13.6%	16.7%	10.0%	11.7%	12.1%	9.6%	10.5%	12.9%	17.5%

**Table 6.6 Frequency of Water Quality Excursions for Scenario II**

Sub-basin	SSF001	SSF002	SSF000	SSF006	SMI002	SMI004	SMI000	SMU002	SMU004	SMU000	SMS000
<b>Geometric Mean Criterion</b>											
All data	0.3%	0.0%	0.0%	0.3%	0.0%	0.0%	0.0%	0.0%	0.0%	0.6%	1.7%
Winter	0.5%	0.0%	0.0%	0.6%	0.0%	0.0%	0.0%	0.0%	0.0%	0.7%	1.9%
Rec Season	0.0%	0.0%	0.0%	0.0%	0.0%	0.0%	0.0%	0.0%	0.0%	0.4%	1.5%
<b>Maximum Criterion</b>											
All data	6.8%	6.9%	6.7%	6.4%	6.5%	7.0%	7.2%	6.6%	7.1%	6.4%	5.6%
Winter	3.1%	3.2%	2.8%	1.8%	3.0%	3.1%	2.9%	3.5%	3.7%	1.9%	1.2%
Rec Season	10.4%	10.5%	10.6%	11.0%	10.0%	10.8%	11.4%	9.6%	10.5%	10.8%	10.0%

Both scenarios have been demonstrated to provide load reductions that will satisfy the maximum water quality criteria for primary and secondary recreational periods. In particular, the prescribed load reductions result in fecal coliform exceedance thresholds much lower than the prescribed 20% level for maximum criterion (i.e. 9.6% to 17.5%) while providing lower than a 10% level for geometric mean criterion (i.e. 0.0% to 8.8%).

## 6.2 Additional Reductions

As discussed previously while both scenarios clearly meet the maximum acute criteria they do not meet the chronic criteria. Additional reductions are thus needed to achieve full compliance with the water quality standard. These additional reductions were estimated external to the simulation model, as described below.

Under the TMDL scenarios, excursions of the geometric mean criterion occur mostly within the downstream urban area, and primarily at the mouth of Beargrass Creek. Because of the nature of a 30-day geometric mean calculation, these excursions are primarily driven by non-event loads and associated with the elevated fecal coliform load assigned to groundwater discharge within the downstream area.

An analysis of the load reductions required to bring each non-compliant simulated geometric mean into compliance can be developed from the mathematical definition of the geometric mean:

$$\ln(GM) = \frac{1}{30} \sum_1^{30} \ln(C_i) = \frac{1}{30} \sum \ln\left(\frac{L_i}{Q_i} \cdot K\right) = \frac{1}{30} \left[ \sum \ln(L_i) - \sum \ln(Q_i) \right] + \ln(K), \text{ or}$$



$$\sum \ln(L_i) = 30 \ln(GM) + \sum \ln(Q_i) - 30 \ln(K),$$

where GM is the geometric mean, C is concentration, L is load, Q is flow, and K is a conversion factor from load over flow to concentration. The fraction of the log-space load (as an average over the 30-day period) that achieves the standard is thus

$$\frac{30 \ln(std) + \sum \ln(Q) - 30 \ln(K)}{30 \ln(GM) + \sum \ln(Q) - 30 \ln(K)}.$$

The reduction is in log space and so is scale dependent on back transformation. Further, the log-space average reduction represents a constant fraction of the simulated log-transformed load (rather than a constant amount), such that the percentage reduction increases as the simulated load increases. For the purposes of the TMDL, it is desirable to determine the constant amount of reduction in load over each day in the 30-day averaging period that is necessary to achieve the geometric mean criterion on each non-compliant day. Unfortunately, there is not a closed-form algebraic solution for this amount. However, the requisite equal-amount reductions, for each day on which the geometric mean exceeds the criterion, can be determined through numerical optimization. This optimization was performed with a check to confirm that the required reductions did not exceed the simulated load for any day within the 30-day averaging period.

Accordingly, equal-amount reductions were calculated for each day's 30-day geometric mean at each location where the geometric mean criterion was still exceeded under the two scenarios described above. The remaining excursions tend to occur in blocks of several days, driven by the same high concentration prediction that is contained within many consecutive rolling 30-day geometric means. Therefore, to translate to annual loads, the load reduction for each individual day is the maximum reduction required to achieve the criterion on the current day and following 29 days. The sum of these daily reductions is then normalized to an annual basis over the 5-year simulation period. The resulting modified concentrations achieve the geometric criterion on all days within the simulation period.

The geometric mean is associated with the median, rather than the arithmetic average, and the approach taken assumes an equal-amount reduction on all days within a 30-day period. Therefore, the additional reductions are most appropriately associated with the groundwater baseflow loading component, which persists over time, rather than with the intermittent load from MS4 stormwater.

The final permanent reductions required to meet the water quality criteria are provided in Tables 6.7-6.10. The resulting frequency of excursions are provided in Tables 6.11 and 6.12.

**Table 6.7 Summary of Final Loading Reductions for Scenario I: CSO  
Storage/Treatment per Subbasin and Source Category**

SUB-WATERSHED	SUB-BASIN	Average Annual Loading Reduction	WASTELOAD REDUCTION SSO sources	WASTELOAD REDUCTION CSO sources	WASTELOAD REDUCTION MS4 sources	WASTELOAD and LOAD REDUCTION Groundwater sources
<b>BEARGRASS</b>						
	SMS000	96%	100%	98%	95%	88%
	SSF006	96%	100%	98%	95%	89%
<b>MUDDY FORK BEARGRASS CREEK</b>						
	SMU000	95%	100%	NA	95%	46%
	SMU002	95%	100%	NA	95%	46%
	SMU004	95%	100%	NA	95%	46%
<b>MIDDLE FORK BEARGRASS CREEK</b>						
	SMI000	95%	100%	98%	95%	86%
	SMI004	95%	100%	98%	95%	90%
	SMI002	95%	100%	NA	95%	86%
<b>SOUTH FORK BEARGRASS CREEK</b>						
	SSF000	96%	100%	98%	95%	86%
	SSF002	96%	100%	98%	95%	78%
	SSF001	95%	100%	NA	95%	42%

**Table 6.8 Summary of Final Loading Reductions for Scenario I: CSO  
Storage/Treatment per Stream Segment and Source Category**

SUB-WATERSHED RIVER MILE	STATISTIC	Average Annual Loading Reduction	WASTELOAD REDUCTION SSO sources	WASTELOAD REDUCTION CSO sources	WASTELOAD REDUCTION MS4 sources	WASTELOAD and LOAD REDUCTION Groundwater sources
<b>BEARGRASS CREEK MAINSTEM</b>						
River Mile 0.5 - 1.8	Maximum	96%	100%	98%	95%	88%
<b>MUDDY FORK BEARGRASS CREEK</b>						
River Mile 0.0 – 6.9	Maximum	95%	100%	NA	95%	46%
<b>MIDDLE FORK BEARGRASS CREEK</b>						
River Mile 0.0-15.3 (entire impaired reach)	Maximum	95%	100%	98%	95%	86%
River Mile 0.0 - 2.0	Maximum	95%	100%	98%	95%	91%
River Mile 2.0 – 2.9	Maximum	95%	100%	98%	95%	90%
River Mile 2.9 – 15.3	Maximum	95%	100%	98%	95%	88%
<b>SOUTH FORK BEARGRASS CREEK</b>						
River Mile 0.0 –13.6 (entire impaired reach)	Maximum	96%	100%	98%	95%	86%
River Mile 0.0 – 2.7	Maximum	96%	100%	98%	95%	86%
River Mile 2.7 – 13.6	Maximum	97%	100%	98%	95%	69%

**Table 6.9 Summary of Final Loading Reductions for Scenario II: Sewer Separation per Subbasin and Source Category**

SUB-WATERSHED	SUB-BASIN	Average Annual Loading Reduction	WASTELOAD REDUCTION SSO sources	WASTELOAD REDUCTION CSO sources	WASTELOAD REDUCTION MS4 sources	WASTELOAD and LOAD REDUCTION Groundwater sources
<b>BEARGRASS</b>						
	SMS000	96%	100%	100%	94%	86%
	SSF006	96%	100%	100%	93%	88%
<b>MUDDY FORK BEARGRASS CREEK</b>						
	SMU000	95%	100%	NA	95%	42%
	SMU002	95%	100%	NA	95%	40%
	SMU004	95%	100%	NA	95%	40%
<b>MIDDLE FORK BEARGRASS CREEK</b>						
	SMI000	95%	100%	100%	94%	88%
	SMI004	95%	100%	100%	94%	86%
	SMI002	95%	100%	NA	95%	81%
<b>SOUTH FORK BEARGRASS CREEK</b>						
	SSF000	97%	100%	100%	93%	85%
	SSF002	97%	100%	100%	94%	77%
	SSF001	95%	100%	NA	95%	40%

**Table 6.10 Summary of Final Loading Reductions for Scenario II: Sewer Separation per Stream Segment and Source Category**

SUB-WATERSHED RIVER MILE	STATISTIC	Average Annual Loading Reduction	WASTELOAD REDUCTION SSO sources	WASTELOAD REDUCTION CSO sources	WASTELOAD REDUCTION MS4 sources	WASTELOAD and LOAD REDUCTION Groundwater sources
<b>BEARGRASS CREEK MAINSTEM</b>						
River Mile 0.5 - 1.8	Maximum	96%	100%	100%	94%	86%
<b>MUDDY FORK BEARGRASS CREEK</b>						
River Mile 0.0 – 6.9	Maximum	95%	100%	NA	95%	42%
<b>MIDDLE FORK BEARGRASS CREEK</b>						
River Mile 0.0-15.3 (entire impaired reach)	Maximum	95%	100%	100%	94%	88%
River Mile 0.0 - 2.0	Maximum	95%	100%	100%	94%	88%
River Mile 2.0 – 2.9	Maximum	95%	100%	100%	94%	86%
River Mile 2.9 – 15.3	Maximum	95%	100%	100%	95%	84%
<b>SOUTH FORK BEARGRASS CREEK</b>						
River Mile 0.0 –13.6 (entire impaired reach)	Maximum	97%	100%	100%	93%	85%
River Mile 0.0 – 2.7	Maximum	97%	100%	100%	93%	85%
River Mile 2.7 – 13.6	Maximum	97%	100%	100%	96%	68%

**Table 6.11 Final Frequency of Water Quality Excursions for Scenario I**

Sub-basin	SSF001	SSF002	SSF000	SSF006	SMI002	SMI004	SMI000	SMU002	SMU004	SMU000	SMS000
<b>Geometric Mean Criterion</b>											
All data	0.0%	0.0%	0.0%	0.0%	0.0%	0.0%	0.0%	0.0%	0.0%	0.0%	0.0%
Winter	0.0%	0.0%	0.0%	0.0%	0.0%	0.0%	0.0%	0.0%	0.0%	0.0%	0.0%
Rec Season	0.0%	0.0%	0.0%	0.0%	0.0%	0.0%	0.0%	0.0%	0.0%	0.0%	0.0%
<b>Maximum Criterion</b>											
All data	6.8%	9.0%	9.4%	9.8%	6.5%	7.5%	7.7%	6.6%	7.1%	7.7%	9.6%
Winter	3.1%	5.3%	5.1%	2.8%	3.0%	3.2%	3.2%	3.5%	3.7%	2.4%	1.6%
Rec Season	10.4%	12.6%	13.6%	16.7%	10.0%	11.7%	12.1%	9.6%	10.5%	12.9%	17.5%

**Table 6.12 Final Frequency of Water Quality Excursions for Scenario II**

Sub-basin	SSF001	SSF002	SSF000	SSF006	SMI002	SMI004	SMI000	SMU002	SMU004	SMU000	SMS000
<b>Geometric Mean Criterion</b>											
All data	0.3%	0.0%	0.0%	0.0%	0.0%	0.0%	0.0%	0.0%	0.0%	0.0%	0.0%
Winter	0.5%	0.0%	0.0%	0.0%	0.0%	0.0%	0.0%	0.0%	0.0%	0.0%	0.0%
Rec Season	0.0%	0.0%	0.0%	0.0%	0.0%	0.0%	0.0%	0.0%	0.0%	0.0%	0.0%
<b>Maximum Criterion</b>											
All data	6.8%	6.9%	6.7%	6.4%	6.5%	7.0%	7.2%	6.6%	7.1%	6.4%	5.6%
Winter	3.1%	3.2%	2.8%	1.8%	3.0%	3.1%	2.9%	3.5%	3.7%	1.9%	1.2%
Rec Season	10.4%	10.5%	10.6%	11.0%	10.0%	10.8%	11.4%	9.6%	10.5%	10.8%	10.0%

### 6.3 TMDL and Allocations

Once the TMDL for the watershed has been determined, the associated pollutant must be allocated between KPDES-permitted loads (i.e. wasteload allocations) including both point source and MS4 nonpoint source and non-permitted (no KPDES permit) nonpoint source loads (i.e. load allocations). The difference between the initial loading and the associated TMDL allocations provides the amount of reduction required to meet water quality standards.

From a regulatory perspective, wasteload allocations are associated with KPDES-permitted point and nonpoint sources in the watershed. There are 57 permitted CSO point sources in the Beargrass Creek watershed and numerous documented SSOs. Since the SSOs are illegal, these sources have been assigned wasteload allocations of zero. The permitted CSO and MS4 loads have allocations under the wasteload. For the purposes of this TMDL, it is assumed that the groundwater source of fecal coliforms is associated with failing sewer lines, septic systems, or surface water sources that have migrated into the groundwater. Since the failing sewer line source is ultimately related to a KPDES-permitted source (the Morris Forman Wastewater Treatment Plant), this source would be allocated as part of the wasteload; however, it is an illegal source and receives an allocation of zero. Surface water sources that have migrated into the groundwater and septic system sources receive an allocation under the load allocation; however, failing septic systems are illegal and should be removed or repaired. The final TMDL is allocated between CSO sources (permit # KY0022411), MS4 stormwater sources (permit numbers KYS000001 and KYS000003), and legal groundwater sources.

Summarizing the TMDL and associated allocations presents some challenges, because different types of sources are present on different days and the relevant water quality standards allow a certain percentage of excursions. The allocations are most clearly summarized in terms of annual loads; however, recent court rulings require that all TMDLs and associated allocations contain an explicit daily component. Therefore, the allocations are first expressed on an annual average basis. The daily component is then expressed consistent with USEPA (2007) guidance through specification of a daily average and a daily “maximum” value, which provide a basis for evaluation of future monitoring data. The daily average is simply the average annual load from the TMDL scenario divided by 365.25 days (which combines days with and without wet weather flows), while the maximum value is expressed as the 95<sup>th</sup> percentile of daily values from the continuous simulation. Use of the 95<sup>th</sup> percentile, rather than the absolute maximum, helps protect against the possible presence of anomalous outliers in the model simulation and adds an additional Margin of Safety to the TMDL. The annual and daily allocations for each sub-watershed and each sub-basin are provided in Tables 6.13-6.22.

**Table 6.13 Average Annual Allocations to Achieve the TMDL (Scenario I with Additional Reductions) by Subbasin and Source Category**

SUB-WATERSHED	SUB-BASIN	Average Annual Loadings (cfu/yr)	Wasteload Allocation (cfu/yr) SSO Sources	Wasteload Allocation (cfu/yr) CSO Sources	Wasteload Allocation (cfu/yr) MS4 Sources	Wasteload Allocation (cfu/yr) KPDES Sources	Load Allocation (cfu/yr) Groundwater Nonpoint Sources
<b>BEARGRASS</b>							
	SMS000	7.47E+11	0.00E+00	0.00E+00	6.64E+11	0.00E+00	5.28E+10
	SSF006	2.34E+13	0.00E+00	1.99E+13	3.22E+12	0.00E+00	1.67E+11
<b>MUDDY FORK BEARGRASS CREEK</b>							
	SMU000	3.08E+13	0.00E+00	0.00E+00	3.01E+13	1.38E+09	5.78E+11
	SMU002	3.94E+13	0.00E+00	0.00E+00	3.90E+13	1.38E+09	3.60E+11
	SMU004	3.06E+13	0.00E+00	0.00E+00	3.04E+13	0.00E+00	2.32E+11
<b>MIDDLE FORK BEARGRASS CREEK</b>							
	SMI000	1.87E+13	0.00E+00	9.17E+12	9.06E+12	0.00E+00	3.08E+11
	SMI004	4.12E+13	0.00E+00	1.68E+13	2.33E+13	0.00E+00	6.43E+11
	SMI002	2.47E+14	0.00E+00	0.00E+00	2.44E+14	0.00E+00	2.51E+12
<b>SOUTH FORK BEARGRASS CREEK</b>							
	SSF000	6.64E+13	0.00E+00	6.34E+13	2.61E+12	0.00E+00	4.09E+11
	SSF002	1.30E+14	0.00E+00	9.65E+13	3.26E+13	1.38E+09	1.21E+12
	SSF001	2.43E+14	0.00E+00	0.00E+00	2.26E+14	1.27E+13	3.88E+12

**Table 6.14 Average Annual Allocations to Achieve the TMDL (Scenario I with Additional Reductions) by Stream Segment and Source Category**

SUB-WATERSHED	STATISTIC	Average Annual Loadings (cfu/yr)	Wasteload Allocation (cfu/yr) SSO Sources	Wasteload Allocation (cfu/yr) CSO Sources	Wasteload Allocation (cfu/yr) MS4 Sources	Wasteload Allocation (cfu/yr) KPDES Sources	Load Allocation (cfu/yr) Groundwater Nonpoint Sources
<b>BEARGRASS CREEK MAINSTEM</b>							
River Mile 0.5 - 1.8	Average	2.42E+13	0.00E+00	1.99E+13	3.89E+12	0.00E+00	2.19E+11
<b>MUDDY FORK BEARGRASS CREEK</b>							
River Mile 0.0 – 6.9	Average	1.01E+14	0.00E+00	0.00E+00	9.95E+13	2.76E+09	1.17E+12
<b>MIDDLE FORK BEARGRASS CREEK</b>							
River Mile 0.0-15.3 (entire impaired reach)	Average	3.06E+14	0.00E+00	2.60E+13	2.76E+14	0.00E+00	3.46E+12
River Mile 0.0 - 2.0	Average	1.87E+13	0.00E+00	9.17E+12	9.06E+12	0.00E+00	3.08E+11
River Mile 2.0 – 2.9	Average	2.76E+13	0.00E+00	5.23E+12	2.16E+13	0.00E+00	4.34E+11
River Mile 2.9 – 15.3	Average	2.60E+14	0.00E+00	1.16E+13	2.45E+14	0.00E+00	2.72E+12
<b>SOUTH FORK BEARGRASS CREEK</b>							
River Mile 0.0 –13.6 (entire impaired reach)	Average	4.40E+14	0.00E+00	1.60E+14	2.61E+14	1.27E+13	5.53E+12
River Mile 0.0 – 2.7	Average	9.11E+13	0.00E+00	8.61E+13	4.42E+12	0.00E+00	6.33E+11
River Mile 2.7 – 13.6	Average	3.49E+14	0.00E+00	7.39E+13	2.57E+14	1.27E+13	4.90E+12

**Table 6.15 Average Daily and 95% Percentile Loadings to Achieve TMDL (Scenario I with Additional Reductions) by Subwatershed and Source Category**

SUB-WATERSHED	STAT	TMDL (cfu/day)	Wasteload Allocation (cfu/day) SSO Sources	Wasteload Allocation (cfu/day) CSO Sources	Wasteload Allocation (cfu/day) MS4 Sources	Wasteload Allocation (cfu/day) KPDES Sources	Load Allocation (cfu/day) Groundwater Nonpoint Sources
<b>BEARGRASS CREEK MAINSTEM</b>							
	Average	6.58E+10	0.00E+00	5.46E+10	1.06E+10	0.00E+00	6.01E+08
	95%	4.11E+11	0.00E+00	3.32E+11	7.52E+10	0.00E+00	4.23E+09
<b>MUDDY FORK BEARGRASS CREEK</b>							
	Average	2.76E+11	0.00E+00	0.00E+00	2.73E+11	7.57E+06	3.20E+09
	95%	1.91E+12	0.00E+00	0.00E+00	1.90E+12	7.57E+06	1.37E+10
<b>MIDDLE FORK BEARGRASS CREEK</b>							
	Average	8.36E+11	0.00E+00	7.12E+10	7.56E+11	0.00E+00	9.47E+09
	95%	6.01E+12	0.00E+00	4.66E+11	5.47E+12	0.00E+00	6.27E+10
<b>SOUTH FORK BEARGRASS CREEK</b>							
	Average	1.20E+12	0.00E+00	4.38E+11	7.17E+11	3.48E+10	1.51E+10
	95%	8.07E+12	0.00E+00	2.68E+12	5.29E+12	3.48E+10	6.39E+10

**Table 6.16 Average Daily and 95% Percentile Loadings to Achieve TMDL  
(Scenario I with Additional Reductions) by Subbasin and Source Category**

SUB-WATERSHED / SUB-BASIN	STATISTIC	TMDL (cfu/day)	Wasteload Allocation (cfu/day) SSO Sources	Wasteload Allocation (cfu/day) CSO Sources	Wasteload Allocation (cfu/day) MS4 Sources	Wasteload Allocation (cfu/day) KPDES Sources	Load Allocation (cfu/day) Groundwater Nonpoint Sources
<b>BEARGRASS</b>							
SMS000	Average	1.96E+09	0.00E+00	0.00E+00	1.82E+09	0.00E+00	1.44E+08
	95%	9.61E+09	0.00E+00	0.00E+00	8.60E+09	0.00E+00	1.01E+09
SSF006	Average	6.38E+10	0.00E+00	0.00E+00	8.82E+09	0.00E+00	4.56E+08
	95%	4.02E+11	0.00E+00	0.00E+00	6.66E+10	0.00E+00	3.22E+09
<b>MUDDY FORK BEARGRASS CREEK</b>							
SMU000	Average	8.41E+10	0.00E+00	0.00E+00	8.25E+10	3.79E+06	1.58E+09
	95%	5.80E+11	0.00E+00	0.00E+00	5.73E+11	3.79E+06	7.25E+09
SMU002	Average	1.08E+11	0.00E+00	0.00E+00	1.07E+11	3.79E+06	9.85E+08
	95%	7.30E+11	0.00E+00	0.00E+00	7.26E+11	3.79E+06	3.95E+09
SMU004	Average	8.38E+10	0.00E+00	0.00E+00	8.31E+10	0.00E+00	6.36E+08
	95%	5.99E+11	0.00E+00	0.00E+00	5.97E+11	0.00E+00	2.52E+09
<b>MIDDLE FORK BEARGRASS CREEK</b>							
SMI000	Average	5.08E+10	0.00E+00	2.51E+10	2.48E+10	0.00E+00	8.45E+08
	95%	3.27E+11	0.00E+00	1.61E+11	1.59E+11	0.00E+00	5.91E+09
SMI004	Average	1.12E+11	0.00E+00	4.65E+10	6.38E+10	0.00E+00	1.76E+09
	95%	7.32E+11	0.00E+00	3.05E+11	4.15E+11	0.00E+00	1.21E+10
SMI002	Average	6.74E+11	0.00E+00	0.00E+00	6.67E+11	0.00E+00	6.86E+09
	95%	4.95E+12	0.00E+00	0.00E+00	4.90E+12	0.00E+00	4.47E+10
<b>SOUTH FORK BEARGRASS CREEK</b>							
SSF000	Average	1.82E+11	0.00E+00	1.74E+11	7.14E+09	0.00E+00	1.12E+09
	95%	1.23E+12	0.00E+00	1.17E+12	5.34E+10	0.00E+00	5.43E+09
SSF002	Average	3.57E+11	0.00E+00	2.64E+11	8.92E+10	3.79E+06	3.32E+09
	95%	2.11E+12	0.00E+00	1.51E+12	5.89E+11	3.79E+06	1.31E+10
SSF001	Average	6.66E+11	0.00E+00	0.00E+00	6.20E+11	3.48E+10	1.06E+10
	95%	4.73E+12	0.00E+00	0.00E+00	4.65E+12	3.48E+10	4.54E+10

**Table 6.17 Average Daily and 95% Percentile Loadings to Achieve the TMDL  
(Scenario I with Additional Reductions) by Stream Segment and Source Category**

SUB-WATERSHED/ River Mile	STATISTIC	Average Annual Loadings (cfu/day)	Wasteload Allocation (cfu/day) SSO Sources	Wasteload Allocation (cfu/day) CSO Sources	Wasteload Allocation (cfu/day) MS4 Sources	Wasteload Allocation (cfu/day) KPDES Sources	Load Allocation (cfu/day) Groundwater Nonpoint Sources
<b>BEARGRASS CREEK WATERSHED</b>							
River Mile 0.5 - 1.8	Average	6.58E+10	0.00E+00	5.46E+10	1.06E+10	0.00E+00	6.01E+08
	95%	4.11E+11	00.00E+00	3.32E+11	7.52E+10	0.00E+00	4.23E+09
<b>MUDDY FORK BEARGRASS CREEK</b>							
River Mile 0.0 – 6.9	Average	2.76E+11	0.00E+00	0.00E+00	2.72E+11	7.57E+06	3.20E+09
	95%	1.91E+12	0.00E+00	0.00E+00	1.90E+12	7.57E+06	1.37E+10
<b>MIDDLE FORK BEARGRASS CREEK</b>							
River Mile 0.0-15.3 (entire impaired reach)	Average	8.36E+11	0.00E+00	7.12E+10	7.55E+11	0.00E+00	9.47E+09
	95%	6.01E+12	0.00E+00	4.66E+11	5.48E+12	0.00E+00	6.27E+10
River Mile 0.0 - 2.0	Average	5.08E+10	0.00E+00	2.51E+10	2.48E+10	0.00E+00	8.45E+08
	95%	3.27E+11	0.00E+00	1.61E+11	1.59E+11	0.00E+00	5.91E+09
River Mile 2.0 - 2.9	Average	7.46E+10	0.00E+00	1.43E+10	5.91E+10	0.00E+00	1.19E+09
	95%	5.32E+11	0.00E+00	9.37E+10	4.29E+11	0.00E+00	9.24E+09
River Mile 2.9 – 15.3	Average	7.11E+11	0.00E+00	3.18E+10	6.72E+11	0.00E+00	7.44E+09
	95%	5.13E+12	0.00E+00	2.08E+11	4.87E+12	0.00E+00	4.79E+10
<b>SOUTH FORK BEARGRASS CREEK</b>							
River Mile 0.0-13.6 (entire impaired reach)	Average	1.20E+12	0.00E+00	4.38E+11	7.16E+11	3.48E+10	1.51E+10
	95%	8.07E+12	0.00E+00	2.68E+12	5.30E+12	3.48E+10	6.39E+10
River Mile 0.0 - 2.7	Average	2.50E+11	0.00E+00	2.36E+11	1.21E+10	0.00E+00	1.73E+09
	95%	1.54E+12	0.00E+00	1.44E+12	8.58E+10	0.00E+00	7.29E+09
River Mile 2.7 – 13.6	Average	9.55E+11	0.00E+00	2.02E+11	7.04E+11	3.48E+10	1.34E+10
	95%	6.54E+12	0.00E+00	1.24E+12	5.21E+12	3.48E+10	5.67E+10



**Table 6.18 Annual Allocations to Achieve the TMDL (Scenario II with Additional Reductions) per Subbasin and Source Category**

SUB-WATERSHED	SUB-BASIN	Average Annual Loadings (cfu/yr)	Wasteload Allocation (cfu/yr) SSO Sources	Wasteload Allocation (cfu/yr) CSO Sources	Wasteload Allocation (cfu/yr) MS4 Sources*	Wasteload Allocation (cfu/yr) KPDES Sources	Load Allocation (cfu/yr) Groundwater Nonpoint Sources
<b>BEARGRASS</b>							
	SMS000	1.64E+12	0.00E+00	0.00E+00	1.55E+12	0.00E+00	7.47E+10
	SSF006	2.67E+13	0.00E+00	0.00E+00	2.64E+13	0.00E+00	2.64E+11
<b>MUDDY FORK BEARGRASS CREEK</b>							
	SMU000	3.08E+13	0.00E+00	0.00E+00	3.01E+13	1.38E+09	5.96E+11
	SMU002	3.94E+13	0.00E+00	0.00E+00	3.90E+13	1.38E+09	3.99E+11
	SMU004	3.06E+13	0.00E+00	0.00E+00	3.04E+13	0.00E+00	2.57E+11
<b>MIDDLE FORK BEARGRASS CREEK</b>							
	SMI000	2.68E+13	0.00E+00	0.00E+00	2.63E+13	0.00E+00	4.44E+11
	SMI004	5.16E+13	0.00E+00	0.00E+00	5.05E+13	0.00E+00	9.17E+11
	SMI002	2.47E+14	0.00E+00	0.00E+00	2.44E+14	0.00E+00	3.35E+12
<b>SOUTH FORK BEARGRASS CREEK</b>							
	SSF000	6.95E+13	0.00E+00	0.00E+00	6.90E+13	0.00E+00	5.06E+11
	SSF002	6.86E+13	0.00E+00	0.00E+00	6.73E+13	1.38E+09	1.32E+12
	SSF001	2.43E+14	0.00E+00	0.00E+00	2.26E+14	1.27E+13	3.98E+12

\*As scenario 2 is a sewer separation scenario, MS4 stormwater that formerly went to the sewage treatment facility now goes to the stream, resulting in some loads being in excess of initial MS4 loads; however, the overall load for the subbasin has still been much reduced in the scenario.

**Table 6.19 Average Annual Allocations to Achieve the TMDL (Scenario II with Additional Reductions) per Stream Segment and Source Category**

SUB-WATERSHED	STATISTIC	Average Annual Loadings (cfu/yr)	Wasteload Allocation (cfu/yr) SSO Sources	Wasteload Allocation (cfu/yr) CSO Sources	Wasteload Allocation (cfu/yr) MS4 Sources	Wasteload Allocation (cfu/yr) KPDES Sources	Load Allocation (cfu/yr) Groundwater Nonpoint Sources
<b>BEARGRASS CREEK MAINSTEM</b>							
River Mile 0.5 - 1.8	Average	2.83E+13	0.00E+00	0.00E+00	2.79E+13	0.00E+00	3.38E+11
<b>MUDDY FORK BEARGRASS CREEK</b>							
River Mile 0.0 – 6.9	Average	1.01E+14	0.00E+00	0.00E+00	9.95E+13	2.76E+09	1.25E+12
<b>MIDDLE FORK BEARGRASS CREEK</b>							
River Mile 0.0-15.3 (entire impaired reach)	Average	3.25E+14	0.00E+00	0.00E+00	3.20E+14	0.00E+00	4.71E+12
River Mile 0.0 - 2.0	Average	2.68E+13	0.00E+00	0.00E+00	2.63E+13	0.00E+00	4.44E+11
River Mile 2.0 – 2.9	Average	4.07E+13	0.00E+00	0.00E+00	3.99E+13	0.00E+00	6.87E+11
River Mile 2.9 – 15.3	Average	2.58E+14	0.00E+00	0.00E+00	2.54E+14	0.00E+00	3.58E+12
<b>SOUTH FORK BEARGRASS CREEK</b>							
River Mile 0.0 –13.6 (entire impaired reach)	Average	3.81E+14	0.00E+00	0.00E+00	3.62E+14	1.27E+13	5.81E+12
River Mile 0.0 – 2.7	Average	8.97E+13	0.00E+00	0.00E+00	8.89E+13	0.00E+00	7.67E+11
River Mile 2.7 – 13.6	Average	2.92E+14	0.00E+00	0.00E+00	2.74E+14	1.27E+13	5.04E+12

**Table 6.20 Average Daily and 95% Percentile Loadings to Achieve the TMDL (Scenario II with Additional Reductions) by Subwatershed and Source Category**

SUB-WATERSHED	STAT	TMDL (cfu/day)	Wasteload Allocation (cfu/day) SSO Sources	Wasteload Allocation (cfu/day) CSO Sources	Wasteload Allocation (cfu/day) MS4 Sources	Wasteload Allocation (cfu/day) KPDES Sources	Load Allocation (cfu/day) Groundwater Nonpoint Sources
<b>BEARGRASS CREEK MAINSTEM</b>							
	Average	7.74E+10	0.00E+00	0.00E+00	7.65E+10	0.00E+00	2.05E+08
	95%	5.86E+11	0.00E+00	0.00E+00	5.81E+11	0.00E+00	1.09E+09
<b>MUDDY FORK BEARGRASS CREEK</b>							
	Average	2.76E+11	0.00E+00	0.00E+00	2.73E+11	7.57E+06	3.43E+09
	95%	1.91E+12	0.00E+00	0.00E+00	1.89E+12	7.57E+06	1.37E+10
<b>MIDDLE FORK BEARGRASS CREEK</b>							
	Average	8.90E+11	0.00E+00	0.00E+00	8.77E+11	0.00E+00	1.29E+10
	95%	6.44E+12	0.00E+00	0.00E+00	6.39E+12	0.00E+00	6.41E+10
<b>SOUTH FORK BEARGRASS CREEK</b>							
	Average	1.04E+12	0.00E+00	0.00E+00	9.93E+11	3.48E+10	1.66E+10
	95%	7.34E+12	0.00E+00	0.00E+00	7.23E+12	3.48E+10	6.92E+10

**Table 6.21 Average Daily and 95% Percentile Loadings to Achieve the TMDL  
(Scenario II with Additional Reductions) by Subbasin and Source Category**

SUB-WATERSHED / SUB-BASIN	STATISTIC	TMDL (cfu/day)	Wasteload Allocation (cfu/day) SSO Sources	Wasteload Allocation (cfu/day) CSO Sources	Wasteload Allocation (cfu/day) MS4 Sources	Wasteload Allocation (cfu/day) KPDES Sources	Load Allocation (cfu/day) Groundwater Nonpoint Sources
<b>BEARGRASS</b>							
SMS000	Average	4.46E+09	0.00E+00	0.00E+00	4.25E+09	0.00E+00	2.05E+08
	95%	3.09E+10	0.00E+00	0.00E+00	2.98E+10	0.00E+00	1.09E+09
SSF006	Average	7.29E+10	0.00E+00	0.00E+00	7.22E+10	0.00E+00	7.22E+08
	95%	5.55E+11	0.00E+00	0.00E+00	5.51E+11	0.00E+00	3.71E+09
<b>MUDDY FORK BEARGRASS CREEK</b>							
SMU000	Average	8.41E+10	0.00E+00	0.00E+00	8.25E+10	3.79E+06	1.63E+09
	95%	5.80E+11	0.00E+00	0.00E+00	5.73E+11	3.79E+06	7.25E+09
SMU002	Average	1.08E+11	0.00E+00	0.00E+00	1.07E+11	3.79E+06	1.09E+09
	95%	7.30E+11	0.00E+00	0.00E+00	7.26E+11	3.79E+06	3.95E+09
SMU004	Average	8.38E+10	0.00E+00	0.00E+00	8.31E+10	0.00E+00	7.05E+08
	95%	5.99E+11	0.00E+00	0.00E+00	5.96E+11	0.00E+00	2.52E+09
<b>MIDDLE FORK BEARGRASS CREEK</b>							
SMI000	Average	7.31E+10	0.00E+00	0.00E+00	7.19E+10	0.00E+00	1.22E+09
	95%	4.84E+11	0.00E+00	0.00E+00	4.77E+11	0.00E+00	6.14E+09
SMI004	Average	1.41E+11	0.00E+00	0.00E+00	1.38E+11	0.00E+00	2.51E+09
	95%	1.00E+12	0.00E+00	0.00E+00	9.91E+11	0.00E+00	1.33E+10
SMI002	Average	6.76E+11	0.00E+00	0.00E+00	6.67E+11	0.00E+00	9.16E+09
	95%	4.95E+12	0.00E+00	0.00E+00	4.92E+12	0.00E+00	4.47E+10
<b>SOUTH FORK BEARGRASS CREEK</b>							
SSF000	Average	1.90E+11	0.00E+00	0.00E+00	1.89E+11	0.00E+00	1.39E+09
	95%	1.30E+12	0.00E+00	0.00E+00	1.29E+12	0.00E+00	6.18E+09
SSF002	Average	1.88E+11	0.00E+00	0.00E+00	1.84E+11	3.79E+06	3.62E+09
	95%	1.31E+12	0.00E+00	0.00E+00	1.29E+12	3.79E+06	1.39E+10
SSF001	Average	6.66E+11	0.00E+00	0.00E+00	6.20E+11	3.48E+10	1.09E+10
	95%	4.80E+12	0.00E+00	0.00E+00	4.65E+12	3.48E+10	4.54E+10

**Table 6.22 Average Daily and 95% Percentile Loadings to Achieve the TMDL  
(Scenario II with Additional Reductions) by Stream Segment and Source Category**

SUB-WATERSHED/ River Mile	STATISTIC	Average Annual Loadings (cfu/day)	Wasteload Allocation (cfu/day) SSO Sources	Wasteload Allocation (cfu/day) CSO Sources	Wasteload Allocation (cfu/day) MS4 Sources	Wasteload Allocation (cfu/day) KPDES Sources	Load Allocation (cfu/day) Groundwater Nonpoint Sources
<b>BEARGRASS CREEK WATERSHED</b>							
River Mile 0.5 - 1.8	Average	7.75E+10	0.00E+00	0.00E+00	7.65E+10	0.00E+00	9.26E+08
	95%	3.09E+10	0.00E+00	0.00E+00	5.81E+11	0.00E+00	1.09E+09
<b>MUDDY FORK BEARGRASS CREEK</b>							
River Mile 0.0 – 6.9	Average	2.76E+11	0.00E+00	0.00E+00	2.72E+11	7.57E+06	3.43E+09
	95%	1.91E+12	0.00E+00	0.00E+00	1.90E+12	7.57E+06	1.37E+10
<b>MIDDLE FORK BEARGRASS CREEK</b>							
River Mile 0.0-15.3 (entire impaired reach)	Average	8.90E+11	0.00E+00	0.00E+00	8.77E+11	0.00E+00	1.29E+10
	95%	6.44E+12	0.00E+00	0.00E+00	6.38E+12	0.00E+00	6.41E+10
River Mile 0.0 - 2.0	Average	7.31E+10	0.00E+00	0.00E+00	7.19E+10	0.00E+00	1.22E+09
	95%	4.84E+11	0.00E+00	0.00E+00	4.77E+11	0.00E+00	6.14E+09
River Mile 2.0 - 2.9	Average	1.11E+11	0.00E+00	0.00E+00	1.09E+11	0.00E+00	1.88E+09
	95%	8.03E+11	0.00E+00	0.00E+00	7.93E+11	0.00E+00	9.82E+09
River Mile 2.9 – 15.3	Average	6.98E+11	0.00E+00	0.00E+00	6.87E+11	0.00E+00	1.12E+10
	95%	5.04E+12	0.00E+00	0.00E+00	4.99E+12	0.00E+00	4.76E+10
<b>SOUTH FORK BEARGRASS CREEK</b>							
River Mile 0.0-13.6 (entire impaired reach)	Average	1.04E+12	0.00E+00	0.00E+00	9.95E+11	3.48E+10	1.59E+10
	95%	7.89E+12	0.00E+00	0.00E+00	7.79E+12	3.48E+10	6.92E+10
River Mile 0.0 - 2.7	Average	2.46E+11	0.00E+00	0.00E+00	2.43E+11	0.00E+00	2.10E+09
	95%	1.86E+12	0.00E+00	0.00E+00	1.85E+12	0.00E+00	9.14E+09
River Mile 2.7 – 13.6	Average	7.98E+11	0.00E+00	0.00E+00	7.50E+11	3.48E+10	1.38E+10
	95%	6.03E+12	0.00E+00	0.00E+00	5.94E+12	3.48E+10	6.00E+10

As indicated previously, the watershed also contains four KPDES permitted sites in addition to the general Louisville MS4 permit, the Kentucky Transportation Cabinet MS4 permit and the CSO permit associated with the Morris Forman Wastewater Treatment Plant (see Table 1.7). In the absence of extensive data sets for four these sites, an assumption was made that each of these sites is operating at its permitted wasteload (i.e. permitted discharge\*240 cfu/100 ml). Thus, the associated TMDL for each of these point sources is simply equal to this corresponding wasteload where no wasteload reduction is then required (see Table 6.23). The existing wasteloads and the wasteload allocations for all MS4 sources (i.e. Tables 6.20-22) thus reflect the total wasteload in each subwatershed, subbasin, or stream reach, minus any wasteload associated with any of the permitted point sources (i.e. Table 6.23) that happen to discharge to that associated subwatershed, subbasin or stream reach.

**Table 6.23 TMDL (Wasteload Allocations) Associated with KPDES Sites**

KPDES Permit	Description	Subwatershed	River Mile	Permitted Discharge (MGD)	TMDL (cfu/day)
KY0057061	Louisville Zoo: Outfall 001 Outfall 002	300	South Fork 2.7-13.6	4.6	1.27E+13
KYG400146	Residence	940	Muddy Fork	0.0005	1.38E+09
KYG400206	Residence	910	Muddy Fork	0.0005	1.38E+09
KYG400349	Residence	400	South Fork 2.7-13.6	0.0005	1.38E+09

Note: Any expanding or future KPDES-permitted point source must meet permit limits based on the Water Quality Standards in 401 KAR 10:031.

## **7.0 IMPLEMENTATION**

### **7.1 The Goal of the TMDL**

The goal of the TMDL is to identify potential load and wasteload reductions that could be used to satisfy the water quality standards for Beargrass Creek. The TMDL represents a planning document and is not a regulatory or enforcement document. However, the document may be used in support of regulatory decisions via general or specific discharge permits or through the specific provisions of a consent decree as per Sections 303(d)(2) and 303(e) of the Clean Water Act. In addition, the document may be used to help guide the activities of non-regulatory programs. It should be emphasized that the specific reduction scenarios considered by the TMDL may or may not be economically feasible or even physically achievable with existing technologies or currently available best management practices. As a consequence, additional analyses may be required (e.g. through a Long Term Control Plan) in order to identify or refine such solutions. At a minimum, the TMDL does identify and quantify relative sources of impairment along with theoretical load and wasteload reductions that would be necessary to achieve water quality standards, and as such, provides a starting point for any future investigations or associated load or wasteload reduction projects.

### **7.2 Potential Strategies**

Potential fecal coliform management strategies for the Beargrass Creek watershed include: 1) elimination of SSOs, 2) addressing CSOs through either sewer separation or inline or offline storage/treatment, 3) repair or replacement of leaking sewers and trunk lines, and 4) reduction through implementation of appropriate BMPs, including education. Potential vehicles for use in implementing such a strategy are summarized below.

### **7.3 Regulatory Programs**

#### KPDES Wastewater Permit Program

All point source wastewater discharges into Kentucky surface waters are regulated under the National Pollution Discharge Elimination System (NPDES) as part of the CWA. This system is composed of a permit that is issued to the discharger and a requirement to monitor and report the constituents associated with the permit on a regular basis through a Discharge Monitoring Report (DMR). The authority to issue these permits in Kentucky has been delegated to the KDOW. These associated KPDES permits allow the Commonwealth of Kentucky to regulate all point sources so as to be in compliance with the water quality regulations and any associated TMDLs for the associated receiving water body. More information on the Kentucky KPDES program can be found at: <http://www.water.ky.gov>.

### Federal Consent Decree

In August 2005, MSD entered into a consent decree with the United States Environmental Protection Agency (USEPA) and the KDOW. The purpose of the consent decree is to address both CSOs and SSOs in the Louisville Metropolitan area. Over the next eighteen years, MSD is to construct approximately \$800 million in capital sewer improvement projects that will:

- Comply with the CSO policy or minimize the impact of CSOs on water quality and human health, and,
- Eliminate sanitary sewer overflows.

In September 2009, MSD's Integrated Overflow Abatement Plan was accepted by the Federal Department of Justice, Kentucky Department for Environmental Protection and the Environmental Protection Agency and incorporated into MSD's Amended Consent Decree. This plan outlines the most cost-effective means for both sanitary and combined sewer overflow mitigation and identifies the point of diminishing return for these mitigation efforts. As such, this plan defines reasonable and attainable fecal coliform reductions for sewer overflows that can affect water quality within the Beargrass Creek watershed (Justin Gray, 2011 personal communication). The document is available at: <http://www.msdlouky.org/projectwin/ioap.htm>.

### KPDES Stormwater Permit Program

The Kentucky Department for Environmental Protection (DEP) is responsible for administering the state's stormwater management program. Kentucky's stormwater program is closely modeled after the federal NPDES program, which requires stormwater be treated to the maximum extent practicable. Kentucky's DEP stormwater program requires all construction sites disturbing more than one acre, many industrial sites, and MS4s to obtain permit coverage. All MS4s should currently be permitted or be in the permit process. Permitted MS4s are responsible for establishing a Stormwater Management Program (SWMP) that implements all of the requirements established by the federal NPDES program. More information on the Kentucky KPDES stormwater permit program may be found at: <http://www.water.ky.gov>.

The Phase II MS4 permit will take into account the risk of contamination by additional requirements on a site-by-site basis to improve water quality. To ensure compliance with all applicable stormwater regulations the municipality should be contacted if the project takes place in an MS4 community.

### Louisville MSD MS4 Permit

The Louisville Municipal Separate Storm Sewer System (MS4) permit program is the result of the 1987 amendments to the Clean Water Act (CWA), commonly referred to as the Water Quality Act of 1987. In these amendments, Congress mandated that the USEPA address nonpoint source pollution in stormwater runoff. In response, USEPA developed a program to permit the discharge of the stormwater from the MS4s. In September 1998, MSD submitted the MS4 Permit re-application to KDOW on behalf of

nine co-permittees. Since the issuance of the first permit, the co-permittees have changed to include:

- City of Anchorage,
- City of Jeffersontown,
- City of Shively,
- City of St. Matthews,
- Kentucky Transportation Cabinet, District Five
- Louisville-Jefferson County MSD, and
- Louisville Metropolitan Government.

In January 1999, the first MS4 permit for Louisville and Jefferson County expired and the permit re-application was approved by the KDOW in March 2000. This MS4 permit was effective from May 1, 2000 through April 30, 2004. The KDOW issued the permit for four years instead of the traditional five year period so that the permit would coincide with the Kentucky Watershed Management Framework sampling schedule. Watershed management activities for the Salt/Licking Basin Management Unit, which includes Louisville and Jefferson County, began in 1999. KPDES permits for the Salt/Licking Basin Management Unit were scheduled for re-issuance in April 2004. More information about MSD's MS4 program can be found at:

<http://www.msdlouky.org/insidemsd/wwwq/ms4/index.htm>.

The MSD program is classified into seven elements:

- Public Education and Outreach Programs,
- Illicit Discharge Detection and Eliminations,
- Construction Site Stormwater Runoff Controls,
- Post Construction Stormwater Management in New Development and Redevelopment, and
- Pollution Prevention and Good Housekeeping,
- Monitoring, and
- Reporting.

The MS4 program elements of Public Education and Outreach, Construction Site Runoff Controls, Post Construction Controls, and Good Housekeeping/Pollution Prevention Programs are performed by both the co-permittees and MSD through inter-municipal agreements. MSD is solely responsible for the Illicit Discharge Program and the Monitoring and Reporting program elements.

As part of the MS4 stormwater permit for Jefferson County, the Louisville and Jefferson County Metropolitan Sewer District (MSD) also conducts detailed water quality sampling throughout the watershed. This sampling provides another mechanism to monitor the status of fecal coliforms within the watershed and a regulatory mechanism for addressing excessive fecal coliform loads associated with stormwater runoff (Louisville MSD, 2007).



## 7.4 Other Programs

Section 303(e) of the Clean Water Act and 40 CFR Part 130, Section 130.5, require states to have a continuing planning process (CPP) composed of several parts specified in the Act and the regulation. The CPP provides an outline of agency programs and the available authority to address water issues. Under the CPP umbrella, the Watershed Management Branch of KDOW will provide technical support and leadership with developing and implementing watershed plans to address water quality and quantity problems and threats. Developing watershed plans enables more effective targeting of limited restoration funds and resources, thus improving environmental benefit, protection and recovery.

Watershed plans provide an integrative approach for identifying and describing how, when, who and what actions should be taken in order to meet water quality standards. At this time, a comprehensive watershed restoration plan for the Beargrass Creek watershed has not been developed. This TMDL provides fecal coliform allocations and reduction goals that may assist with developing a detailed watershed plan to guide watershed restoration efforts.

A watershed plan for the Beargrass Creek watershed should address both point and nonpoint (i.e. stormwater) sources of pollution in the watershed and should build on existing efforts as well as evaluate new approaches. Because of the specific landscape and location of the impairments in the Beargrass Creek watershed, a watershed plan should incorporate all available restoration and protection mechanisms, including Groundwater Protection Plans, and stormwater and wastewater KPDES permits. A comprehensive watershed plan should consider both voluntary and regulatory approaches to meet water quality standards.

### Kentucky Watershed Management Framework

A Watershed Management Framework approach to Water Quality Management (WQM) was adopted by the KDOW in 1998. The plan divides Kentucky's major drainage basins into five groups of basins which are cycled through a five year staggered process which involves monitoring, assessment, prioritization, plan development, and plan implementation. The major basin that the Beargrass Creek watershed lies within is the Salt River basin. The first phase of the process for the Salt River basin began in 1998 and in 2002 Beargrass Creek was listed as a high priority watershed using the watershed management framework process. As part of the process, a basin coordinator is assigned to each river basin to work with the citizens of the basin to develop a local Watershed Management Team associated with each priority watershed. For more information about the Salt River basin see: <http://www.watersheds.ky.gov/basins/salt/>.

## **7.5 Non-Governmental Organizations**

There are several Non-Governmental Organizations (NGO) operating in the Beargrass Creek watershed that may help in improving the water quality, particularly with regard to nonpoint source issues. These organizations include Beargrass Creek Watershed Council (defunct but can be reestablished), the Salt River Watershed Watch, and Kentucky Waterways Alliance.

### Beargrass Creek Watershed Council

The Beargrass Creek Watershed Council was a local coalition of concerned citizens, agency staff and business owners who came together as the Beargrass Creek Watershed Council (December 2003 – June 2005) to determine and report on the state of the Beargrass Creek watershed. The goals of their efforts were to set the stage for greater involvement from the community, to find ways to improve the watershed, and to preserve Beargrass Creek as a valuable community resource.

### Salt River Watershed Watch

Salt River Watershed Watch is a citizen's water monitoring effort that relies exclusively on volunteers to provide administration, training, and volunteer and equipment coordination. The volunteers measure basic parameters of stream health to determine whether streams meet important "uses" under the Clean Water Act including aquatic life, human recreation, and drinking water.

Several water quality parameters have been monitored by the Salt River Watershed Watch in Beargrass Creek. Three times per year, water samples are collected from twelve sites on Muddy Fork and the Middle and South Forks. Volunteers collect physical measurements, such as temperature, pH, dissolved oxygen, and conductivity. Stream monitoring also includes macroinvertebrate and habitat assessments. Once annually, water samples are tested for bacteria (E. coli and or fecal coliform), selected pesticides, and nutrients. Data from annual monitoring is routinely used to help identify problems in the watershed, and assist with prioritizing streams for restoration and protection activities.

### Kentucky Waterways Alliance

The formation of Kentucky Waterways Alliance (KWA) was the result of a series of meetings sponsored by the Kentucky Environmental Quality Commission. The KWA has a mission to protect and restore Kentucky's waterways and their watersheds through alliances for watershed stewardship. This includes strengthening community and governmental stewardship for the restoration and preservation of Kentucky's water resources. The Alliance promotes networking, communication and mutual support among groups, government agencies, and businesses working on waterway issues.

## **7.6 Modifications**

In the future, KDOW may adjust the individual wasteload allocations (WLAs) in this TMDL to account for new information or circumstances that develop or come to light during the implementation of the TMDL and a review of the new information or circumstances indicate that such adjustments are appropriate. New information generated during TMDL implementation may include, among other things, monitoring data, best management practices (BMPs) effectiveness information and land use information. KDOW will propose adjustments only in the event that any adjusted individual WLA will not result in a change to the total WLA. The adjusted WLA will be set at a level necessary to implement the applicable water quality standard (WQS). KDOW will notify EPA of any adjustments to this TMDL within 30 days of their adoption.

## 8.0 PUBLIC PARTICIPATION

The first iteration of this TMDL was published for a 30-day public notice beginning September 11, 2008 and ending October 13, 2008. A press release was sent to all newspapers in the Commonwealth of Kentucky and an advertisement was purchased in The Courier-Journal, the newspaper of highest circulation in Jefferson County. Additionally, the press release was distributed electronically through the 'Nonpoint Source Pollution Control' mailing list (<http://www.water.ky.gov/sw/nps/Mailing+List.htm>) of persons interested in water quality issues as well as the 'Press Release' mailing list maintained by the Governor's Office of media outlets across the Commonwealth.

The second iteration of this TMDL was published for a 39-day public notice beginning July 15, 2011 and ending August 15, 2011. A press release was sent to all newspapers in the Commonwealth of Kentucky and an advertisement was purchased in The Courier-Journal, the newspaper of highest circulation in Jefferson County. Additionally, the press release was distributed electronically through the 'Nonpoint Source Pollution Control' mailing list (<http://www.water.ky.gov/sw/nps/Mailing+List.htm>) of persons interested in water quality issues as well as the 'Press Release' mailing list maintained by the Governor's Office of media outlets across the Commonwealth.

All comments received during the public notice period have been incorporated into the administrative record for this TMDL. After consideration of each comment received, revisions were made to the final TMDL report, and responses were prepared and mailed to each individual/agency participating in the public notice process.

## 9.0 REFERENCES

Bicknell, B.R, J.C. Imhoff, J.L. Kittle, Jr., T.H. Jobs, and A.S. Donigian, Jr. 2001. HSPF User's Manual, Hydrological Simulation Program-FORTRAN User's Manual for Release 12. Available at <http://hspf.com/pub/hspf>, accessed 10/2/03.

Environmental Laboratory. 1995. CE-QUAL-RIV1: A Dynamic, One-Dimensional (Longitudinal) Water Quality Model for Streams: User's Manual. Instruction Report EL-95-2. U.S. Army Engineer Waterways Experiment Station, Vicksburg, MS.

Justin Gray. Nov. 21, 2011. Personal communication via e-mail.

Jarrett, G.L., A.C. Downs, and P. A. Grace-Jarrett. 1998. Continuous Hydrologic Simulation of Runoff for the Middle Fork and South Fork of the Beargrass Creek Basin in Jefferson County, Kentucky. Water-Resources Investigations Report 98-4182. U.S. Geological Survey, Louisville, KY.

Jarrett, L. and K. Schaffer. 2003. Beargrass Creek Water Quality Model, Final Calibration Report. Prepared by J.E. Edinger Associates, Henryville, IN.

Kentucky Administrative Regulations, 2008, 401 KAR 10:031

KCOT. 2007. Kentucky Commonwealth Office of Technology – Division of Geographic Information, <http://technology.ky.gov/gis/>

Kentucky Division of Water, 1999, KPDES Permit KY0022411 for Morris Forman Wastewater Treatment Plant, October 1, 1999 to September, 30, 2004.

Kentucky Division of Water, 2010, 303(d) List of Waters for Kentucky, Department for Environmental Protection, Kentucky Natural Resources and Environmental Protection Cabinet.

Kentucky Geography Network, 2008. <http://Kygeonet.Ky.go>

Kepferle, R. C., 1974, Geologic Map of the Louisville East Quadrangle, Jefferson County, Kentucky, United States Geologic Survey, MAP GQ-1203.

LOJIC. 2007. Louisville/Jefferson County Information Consortium, <http://www.lojic.org/>

Louisville Metropolitan Sewer District (MSD), 2005, Beargrass Creek Watershed – State of the Streams.

Louisville Metropolitan Sewer District (MSD), 2007, <http://www.msdlouky.org/aboutmsd/>

Louisville and Jefferson County Metropolitan Sewer District (MSD), 2008, MSD's Wastewater/Stormwater Discharge Regulations: Regulations Affecting the Use of Public and Private Sewers and Drains, Regulating the Discharge of Waters and Wastes into the Public Sewer System, and Providing for Corrective Action and Liabilities and Penalties [sic] for the Violation of the Provisions Thereof.

McDowell, R. C. (ed.), 2001, The Geology of Kentucky, USGS Professional Paper 1151 H, on-line version 1.0, cited October 2008, <http://pubs.usgs.gov/prof/p1151h>.

Nelson, H.L., Jr., 2002a, Spatial database of the Anchorage quadrangle, Jefferson and Oldham Counties, Kentucky: Kentucky Geological Survey, ser. 12, Digitally Vectorized Geologic Quadrangle Data DVGQ-906. Adapted from Kepferle, R.C., Wigley, P.B., and

Hawke, B.R., 1971, Geologic map of the Anchorage quadrangle, Jefferson and Oldham Counties, Kentucky: U.S. Geological Survey Geologic Quadrangle Map GQ-906, scale 1:24,000.

Nelson, H.L., Jr., 2002b, Spatial database of the Jeffersontown quadrangle, Jefferson County, Kentucky: Kentucky Geological Survey, ser. 12, Digitally Vectorized Geologic Quadrangle Data DVGQ-999. Adapted from Moore, F.B., Kepferle, R.C., and Peterson, W.L., 1972, Geologic map of the Jeffersontown quadrangle, Jefferson County, Kentucky: U.S. Geological Survey Geologic Quadrangle Map GQ-999, scale 1:24,000.

Nelson, H.L., Jr., 2002c, Spatial database of the Jeffersonville, New Albany, and Charlestown quadrangles, Kentucky-Indiana: Kentucky Geological Survey, ser. 12, Digitally Vectorized Geologic Quadrangle Data DVGQ-1211. Adapted from Kepferle, R.C., 1974, Geologic map of the Jeffersonville, New Albany, and Charlestown quadrangles, Kentucky-Indiana: U.S. Geological Survey Geologic Quadrangle Map GQ-1211, scale 1:24,000.

Nelson, H.L., Jr., 2002d, Spatial database of the Louisville East quadrangle, Jefferson County, Kentucky: Kentucky Geological Survey, ser. 12, Digitally Vectorized Geologic Quadrangle Data DVGQ-1203. Adapted from Kepferle, R.C., 1974, Geologic map of the Louisville East quadrangle, Jefferson County, Kentucky: U.S. Geological Survey Geologic Quadrangle Map GQ-1203, scale 1:24,000.

Nelson, H.L., Jr., and Sparks, T.N., 2002e, Spatial database of the Louisville West and Lanesville quadrangles, Jefferson County, Kentucky: Kentucky Geological Survey, ser. 12, Digitally Vectorized Geologic Quadrangle Data DVGQ-1202. Adapted from Kepferle, R.C., 1974, Geologic map of the Louisville West and Lanesville quadrangles, Jefferson County, Kentucky: U.S. Geological Survey Geologic Quadrangle Map GQ-1202, scale 1:24,000.

Ray, J.A., Webb, J.S., and O'dell, P.W., 1994, Groundwater Sensitivity Regions of Kentucky, Kentucky Division of Water, scale 1:500,000.

Ray, J.A., Blair, R.J., and Webb, J.S., 2008, Karst Groundwater Infiltration of the Sanitary Sewer within the Beargrass Creek Watershed, Jefferson County, Kentucky, Kentucky Water Resources Research Institute Annual Symposium, oral presentation.

Ray, J.A., 2008. Personal communications with Joseph Ray, Groundwater Section, Watershed Management Branch, Division of Water, 200 Fair Oaks Lane, Frankfort, KY, 40601.

Roesner, L.A., Aldrich, J.A. and R.E. Dickinson. 1988. Stormwater Management Model, Version 4, User's Manual: Extran Addendum. EPA/600/3-88/001b (NTIS PB88-236658/AS), U.S. EPA, Athens, GA, 30605.

Tetra Tech and Obrien and Gere. 2007. *Beargrass Creek Water Quality Tool Model Calibration and Validation Report*. Prepared for Louisville and Jefferson County Metropolitan Sewer District by Tetra Tech, Inc., Fairfax, VA and Obrien and Gere, Louisville, Kentucky.

Tetra Tech. 2005. Quality Assurance Project Plan for Beargrass Creek Water Quality Tool and TMDLs Development. Prepared for Louisville and Jefferson County Metropolitan Sewer District by Tetra Tech, Inc., Fairfax, VA.

Thraillkill, J.V., Spangler, L.E., Hopper, W.M., McCann, M.R., Troester, J.W., and Gouzie, D.R., 1982, Groundwater in the Inner Bluegrass Karst Region, Kentucky, University of Kentucky Water Resources Research Institute Report 136, 108 p.

USDA, 1982 Urban Hydrology for Small Watersheds, Engineering Division of the Natural Resource Conservation Service, United States Department of Agriculture, Technical Release-55.

USEPA. 2008. Personal communications with Amy Feingold, TMDL Coordinator, Water Division, EPA Region 4, 61 Forsyth Street SW, Atlanta, Georgia.

USEPA. 2007. Options for Expressing Daily Loads in TMDLs, June 22, 2007. U.S. Environmental Protections Agency Office of Wetlands, Oceans, and Watersheds.

USEPA. 2004. Report to Congress: Impacts and Control of CSOs and SSOs. EPA 833-R-04-001. Office of Water, U.S. Environmental Protection Agency, Washington, DC.

USEPA. 2001. Protocol for Developing Pathogen TMDLs. EPA 841-R-00-002. Office of Water, U.S. Environmental Protection Agency, Washington, DC.

USEPA, 1991. Guidance for Water-Quality-based Decisions: The TMDL Process. EPA440-4-91-001. Office of Water, U.S. Environmental Protection Agency, Washington, DC.

USEPA. 1981. *Clean Water Act*, Sections 303(d), 303(d)(2), and 303(e), 40 CFR Part 130.

USGS, 2007. <http://geonames.usgs.gov>

Wool, T.A., R.B. Ambrose, J.L. Martin, and E.A. Comer, 2003. Water Quality Analysis Simulation Program (WASP), Version 6.0 User's Manual. Region 4, U.S. Environmental Protection Agency, Atlanta, GA.

Zimmerman, W.H., J.C. Ross, J.P. Fehr, B.L. Wilson, D.T. Carroll, and C.D. Luttrell. 1966. Soil Survey of Jefferson County, Kentucky. U.S. Department of Agriculture, Soil Conservation Service.



**APPENDIX A: FECAL COLIFORM OBSERVATIONS  
IN BEARGRASS CREEK**

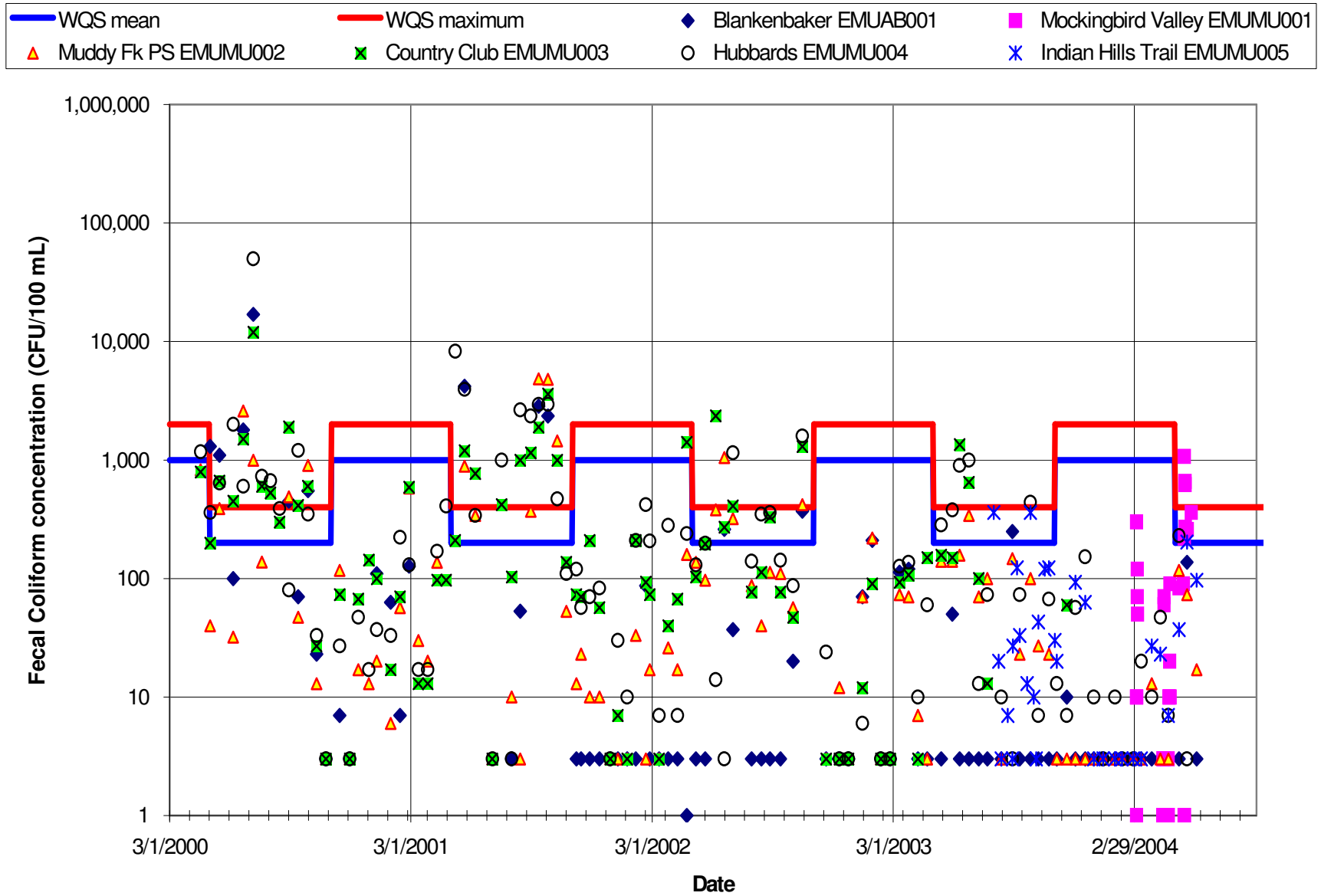


Figure A.1 Fecal Coliform Observations in Muddy Fork of Beargrass Creek (3/1/2000 – 9/1/2004)

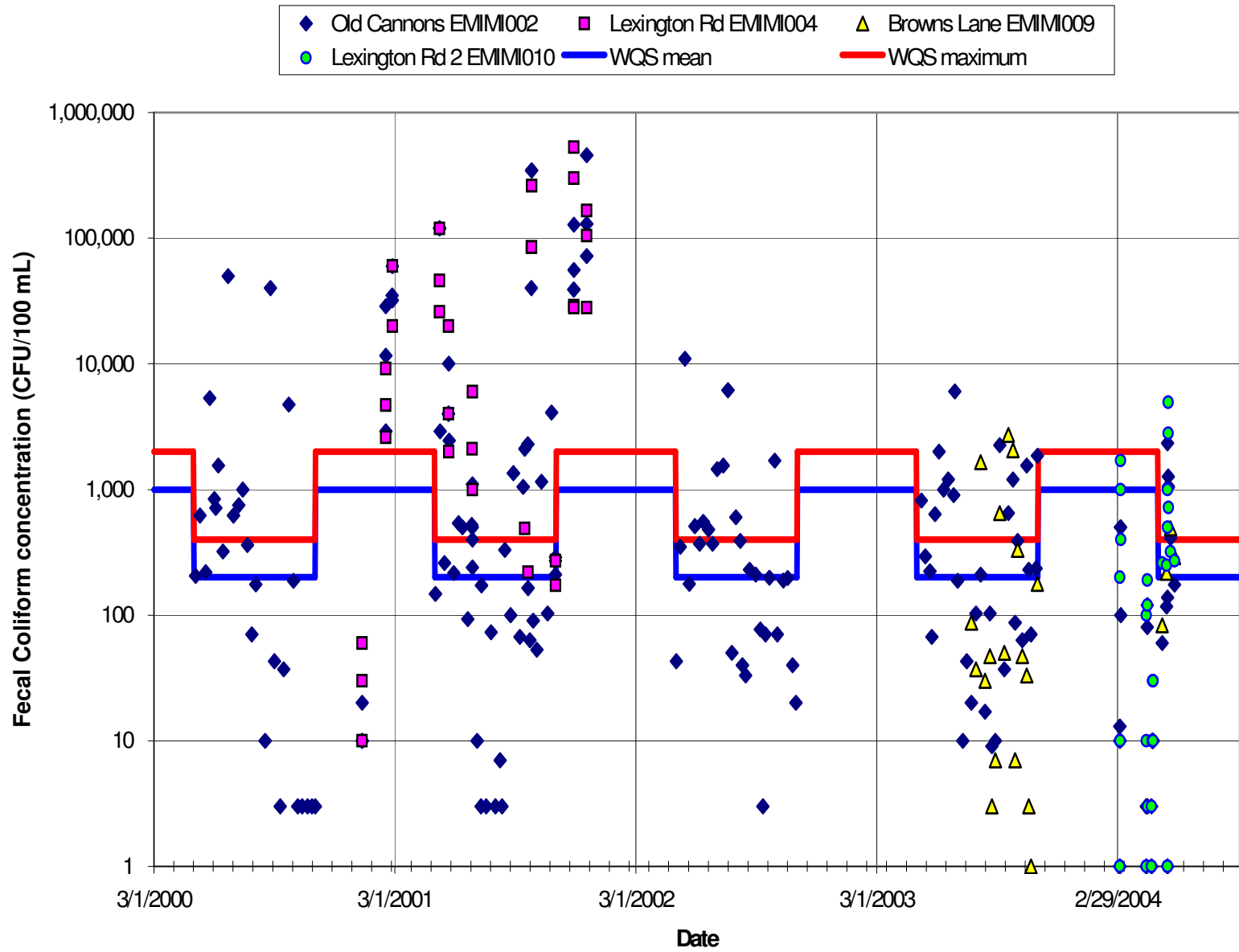


Figure A.2 Fecal Coliform Observations in Middle Fork of Beargrass Creek (3/1/2000 – 9/1/2004)

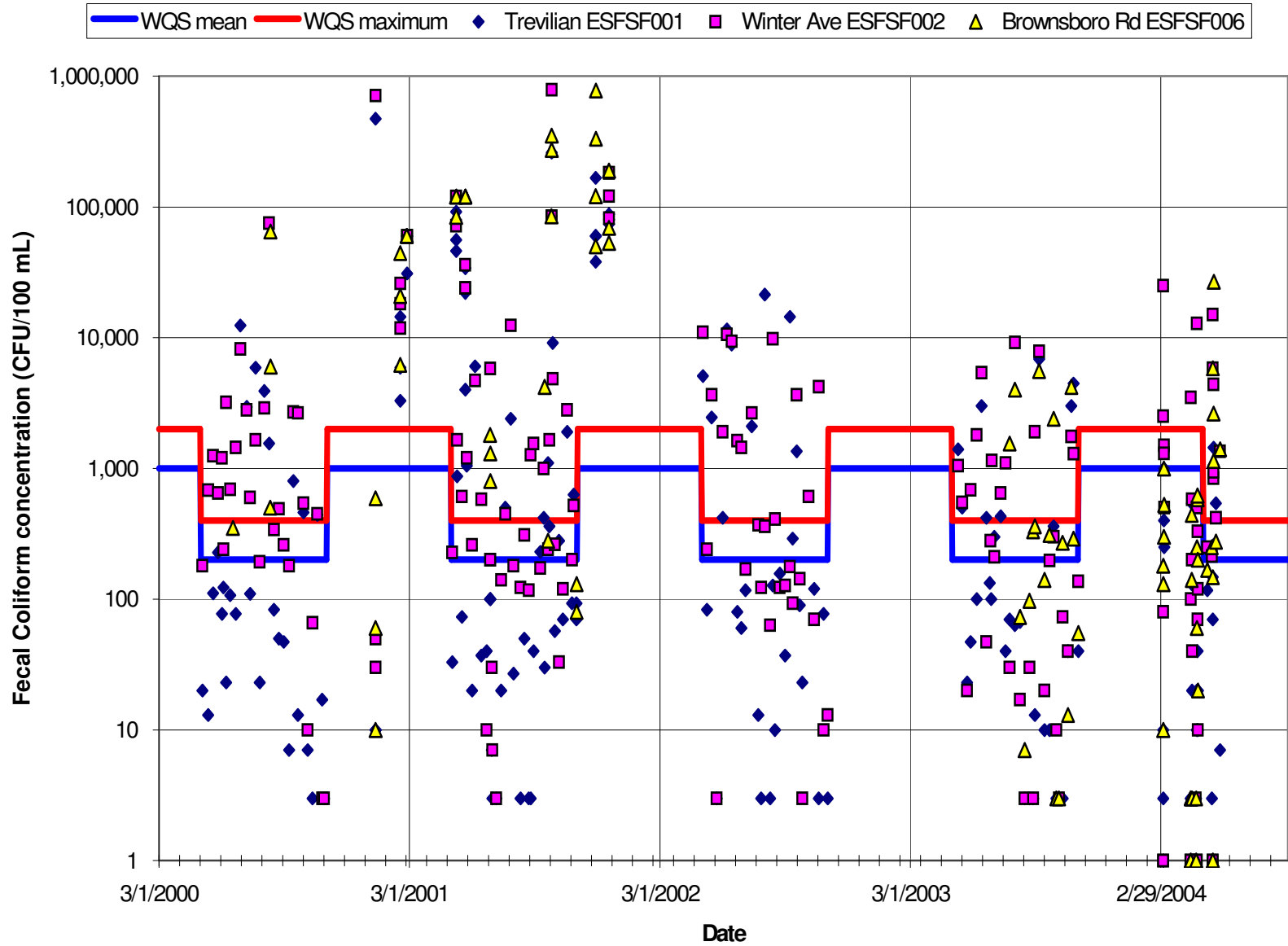


Figure A.3 Fecal Coliform Observations in South Fork of Beargrass Creek (3/1/2000 – 9/1/2004)

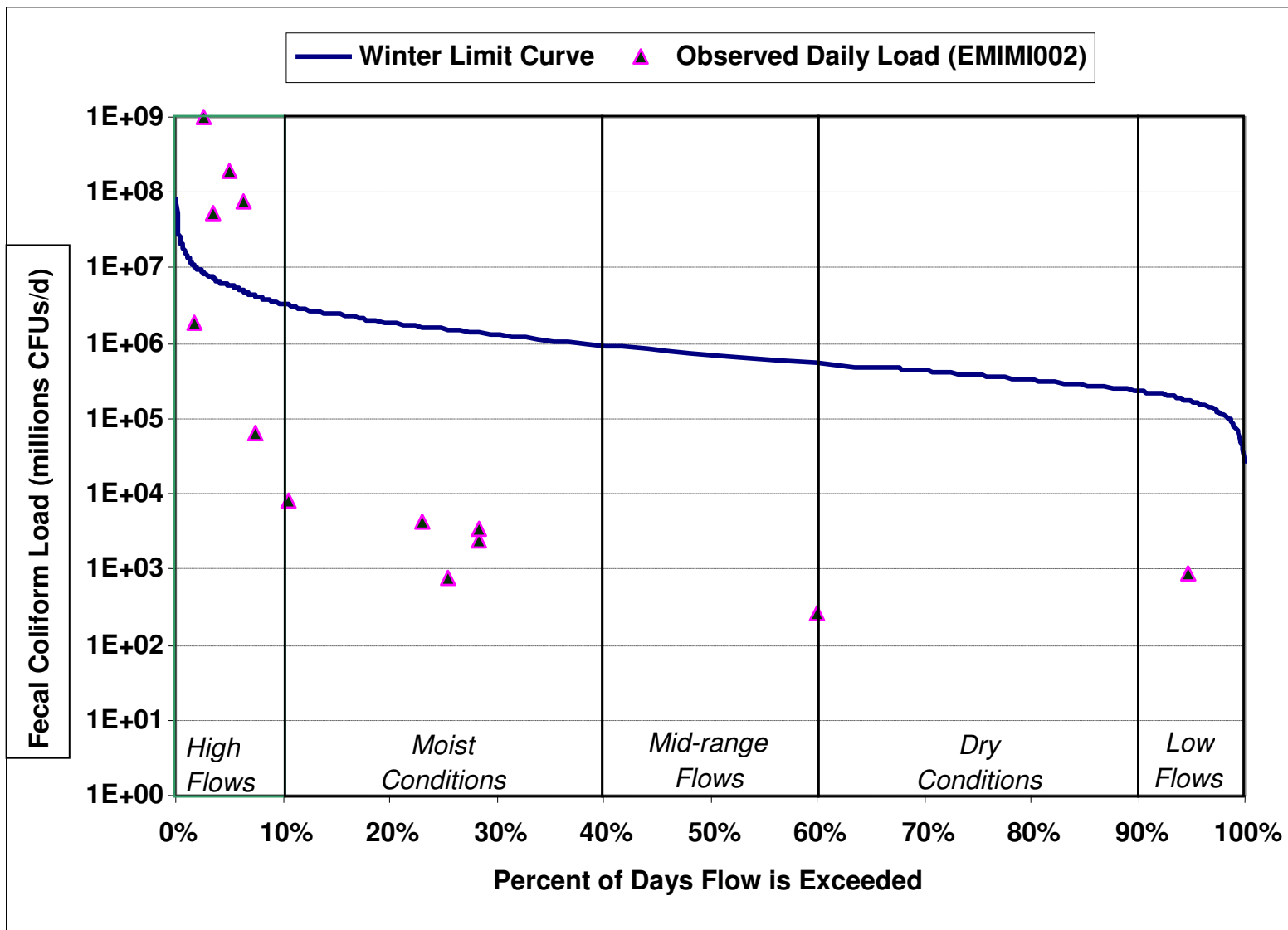


Figure A.4 Load-Duration Curves for Fecal Coliform in Middle Fork Beargrass Creek (Non Recreational Period) (Station EMIMI002)

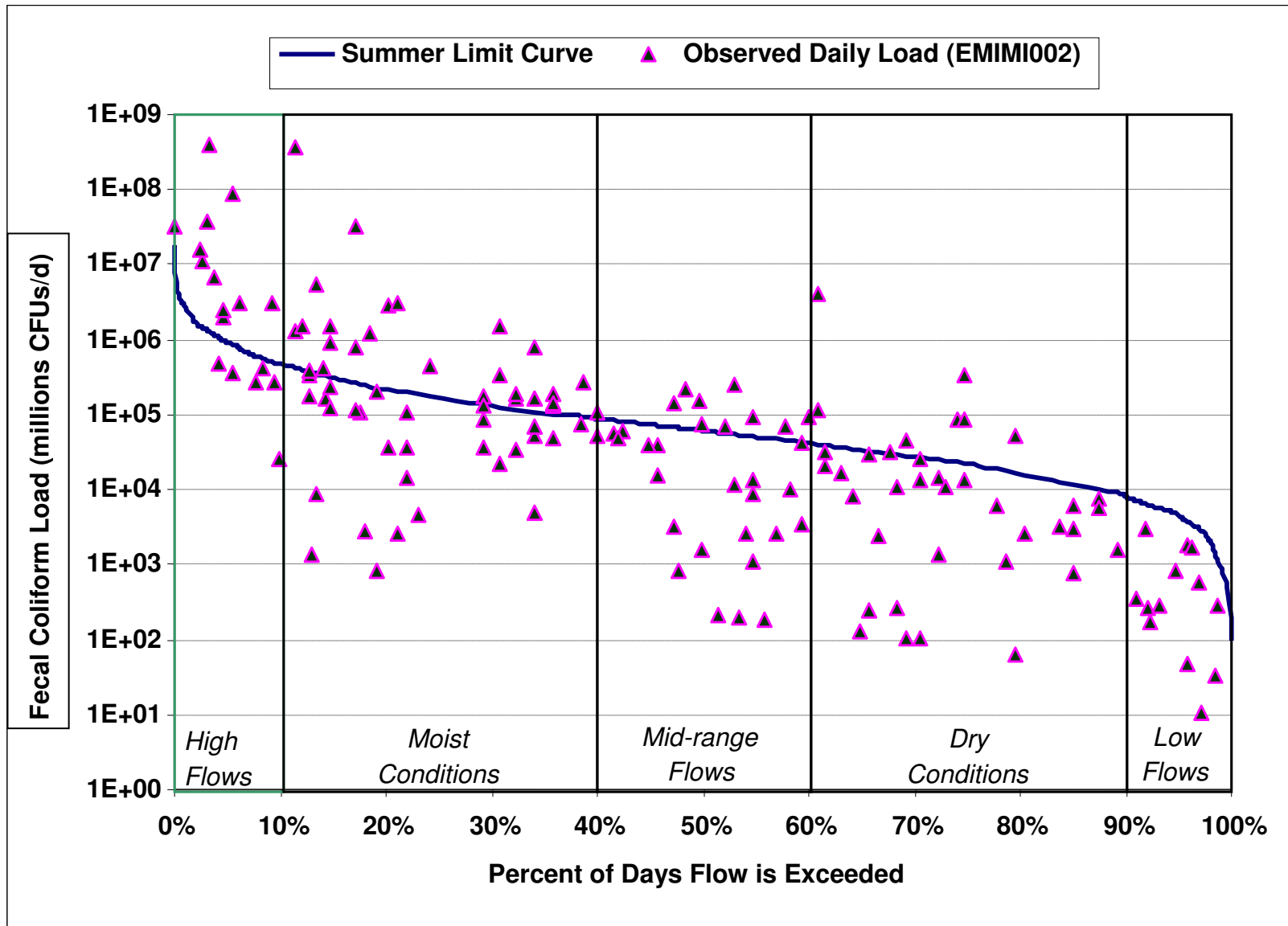


Figure A.5 Load-Duration Curves for Fecal Coliform in Middle Fork Beargrass Creek (Recreational Period)  
(Station EMIMI002)

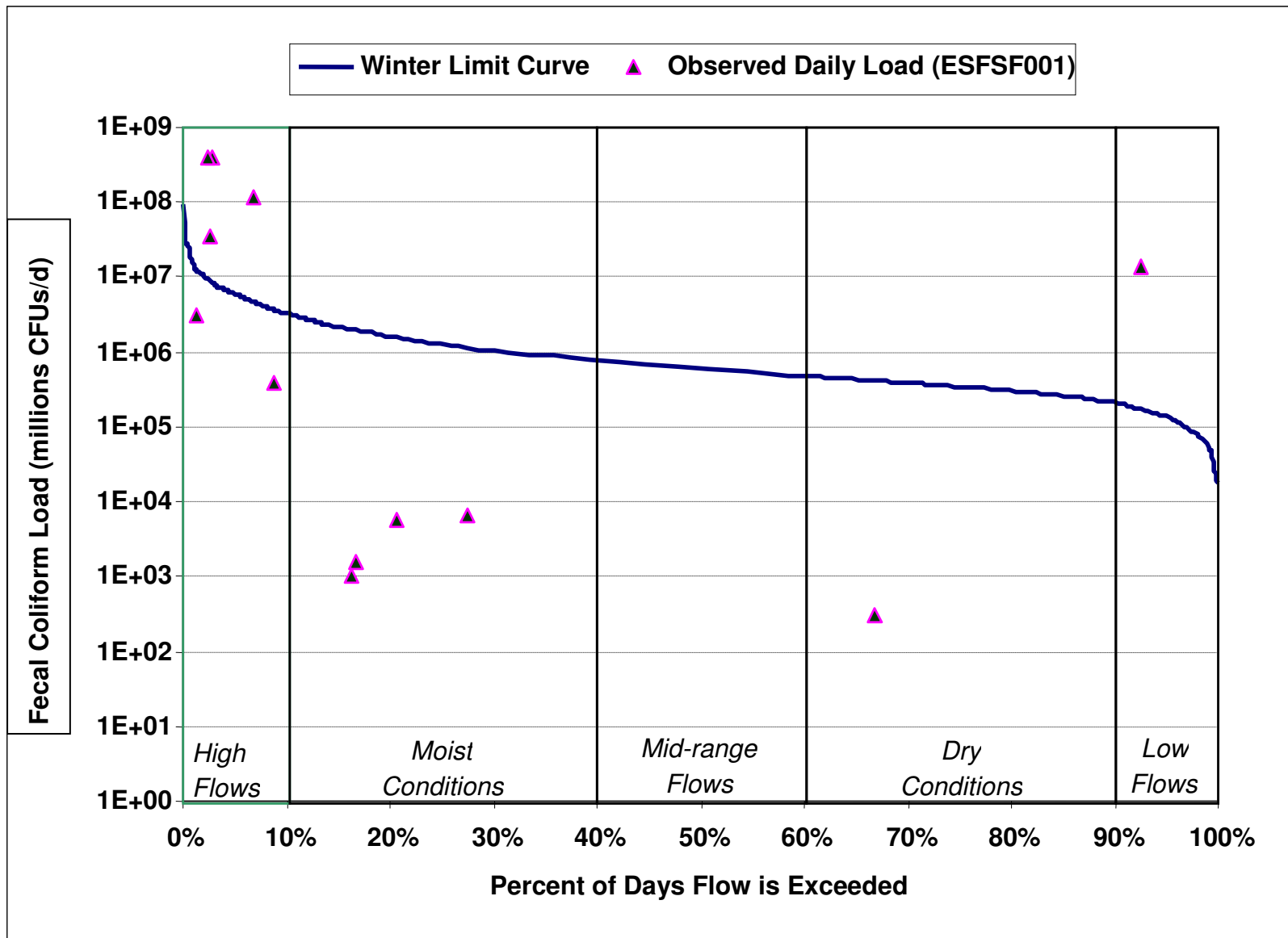


Figure A.6 Load-Duration Curves for Fecal Coliform in South Fork Beargrass Creek (Non Recreational Period) (Station ESFSF001)

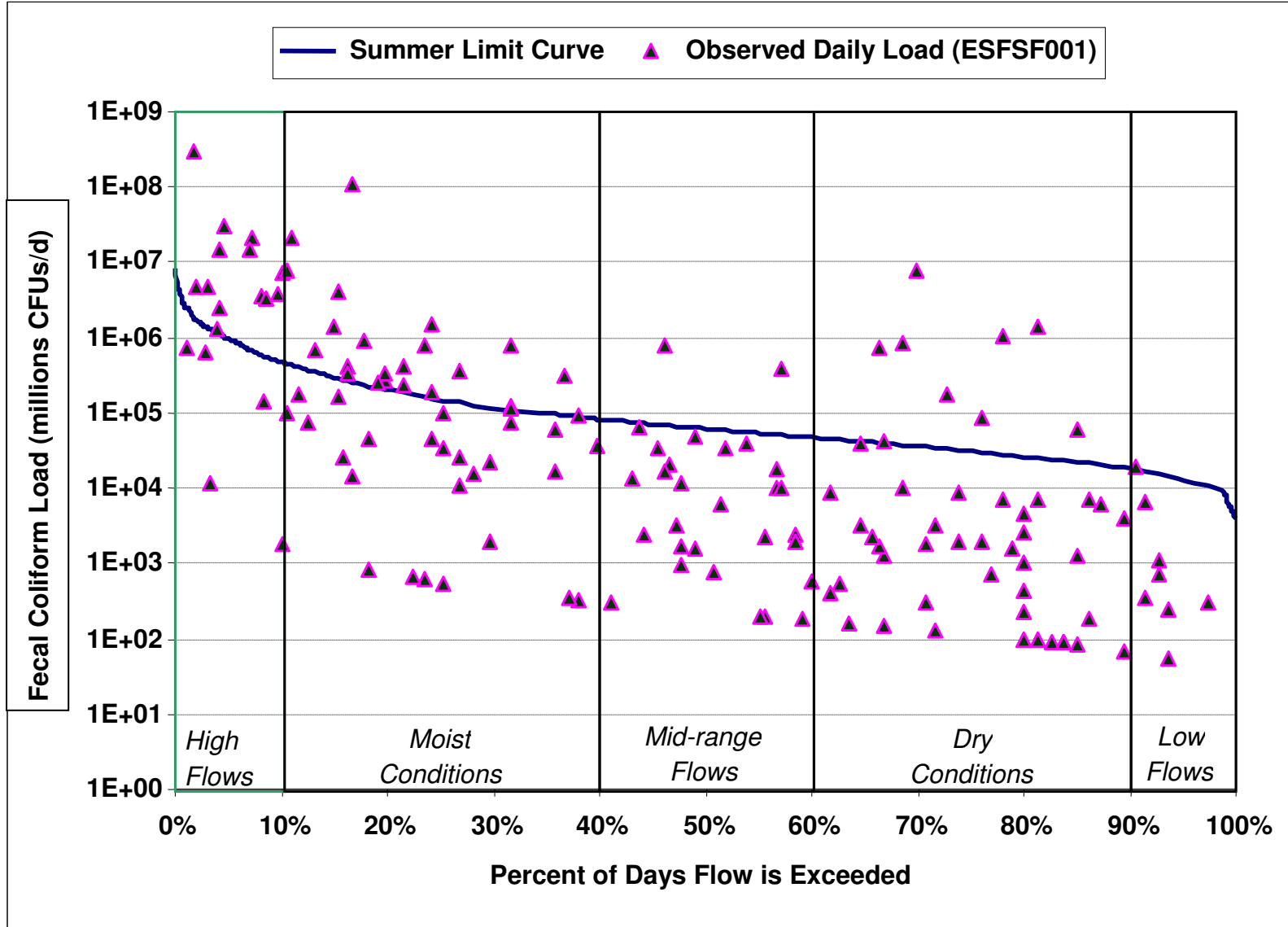


Figure A.7 Load-Duration Curves for Fecal Coliform in South Fork Beargrass Creek (Recreational Period)  
(Station ESFSF001)



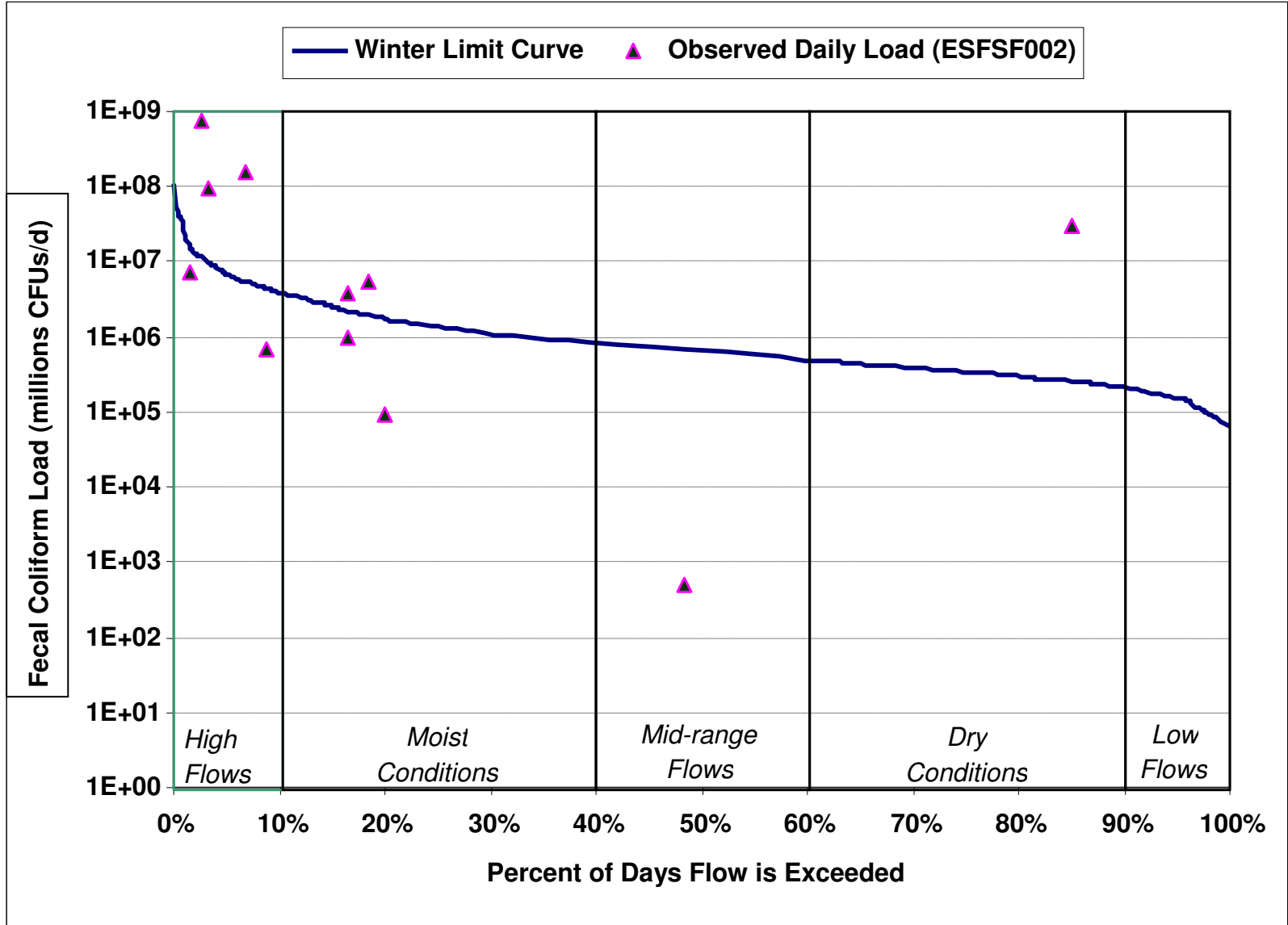


Figure A.8 Load-Duration Curves for Fecal Coliform in South Fork Beargrass Creek (Non Recreational Period) (Station EFSF002)

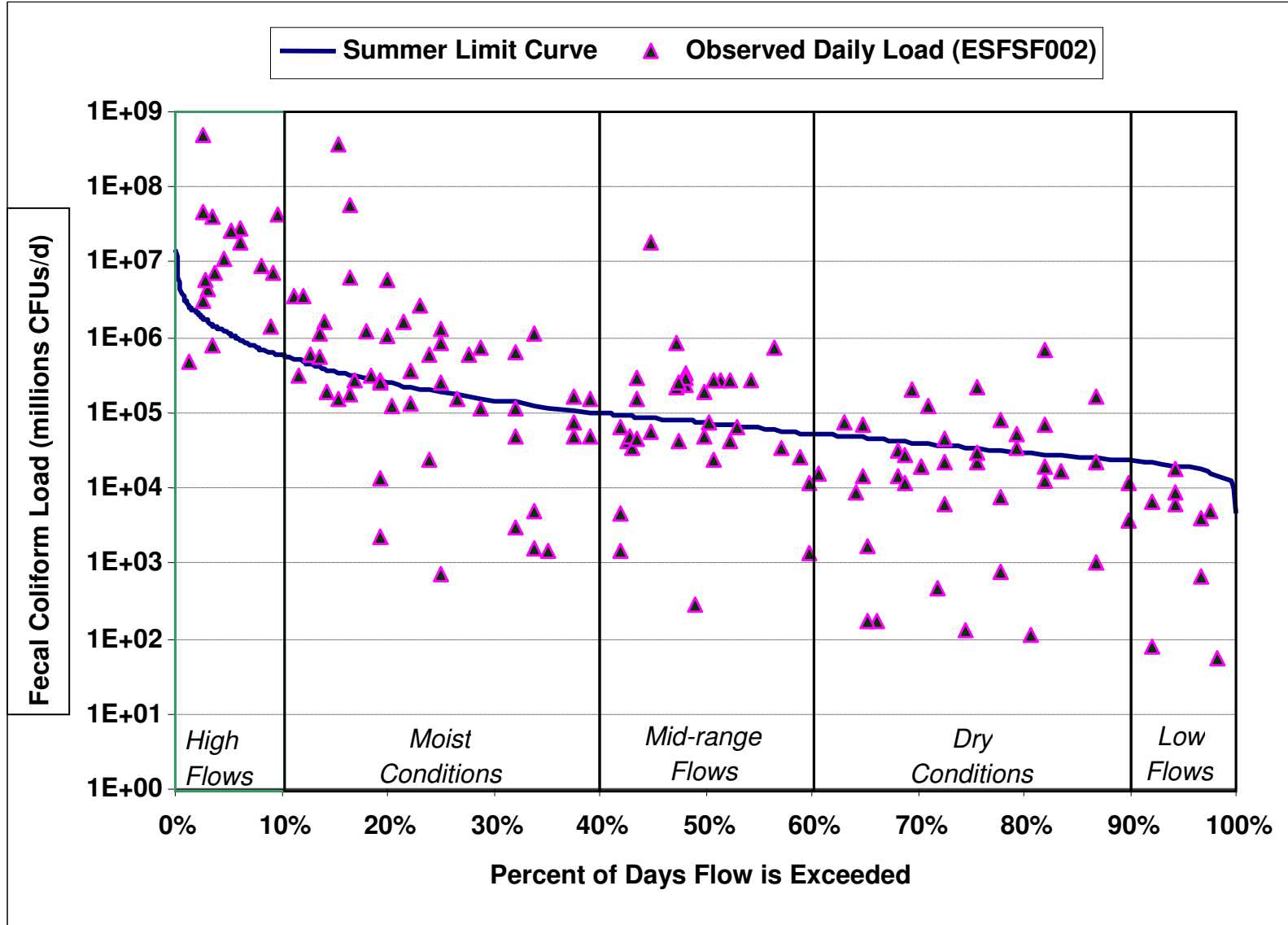


Figure A.9 Load-Duration Curves for Fecal Coliform in South Fork Beargrass Creek (Recreational Period)  
(Station EFSF002)

**Table A.1 Frequency of Excursions of Recreation Season Fecal Coliform Maximum Criterion by Flow Range**

Flow Condition	ESFSF001		ESFSF002		EMIMI002	
	Flow Range (cfs)	Frequency	Flow Range (cfs)	Frequency	Flow Range (cfs)	Frequency
<b>High Flows</b>	869-49.3	75.00%	1550-60	88.24%	1900-48	64.71%
<b>Moist Conditions</b>	49.3-8.4	48.00%	60-10	54.00%	48-9	49.12%
<b>Mid-Range</b>	8.4-4.8	6.90%	10-5.4	47.06%	9-4.2	30.00%
<b>Dry Conditions</b>	4.8-1.9	17.65%	5.4-2.43	30.00%	4.2-0.777	21.62%
<b>Low Flows</b>	1.9-0.41	12.50%	2.43-0.47	0.00%	0.777-0	0.00%

## **APPENDIX B: DESCRIPTION OF THE WATER QUALITY TOOL (WQT)**

### B.1 Detailed Description of the Beargrass Creek Water Quality Tool (WQT)

The Beargrass Creek WQT combines five different simulation models to represent the variety of sources and conditions found in the Beargrass Creek Watershed (see Figure B.1). Potential time series of SSO discharges are first developed off-line using a steady state version of SWMM and are then aggregated and input into HSPF through a series of boundary conditions for each individual reach of the HSPF model. The HSPF model is then used to transport the flows and loads from the SSOs as well as to generate and transport watershed runoff and pollutant loadings down through the channel system. HSPF generated flows and loads from the combined sewer system are also transferred to an SWMM model through the use of the HSPF-SWMM bridge routine and to portions of the RIV-1 model using a PERL script. The SWMM model is run to predict CSO events which are then routed to HSPF or RIV-1 reaches. The HSPF reaches eventually provide the upstream boundary inputs for the RIV-1 model. Direct connections of CSOs to lower Beargrass Creek are processed via the HSPF model for input to RIV-1 and WASP, but this serves only a pass-through function.

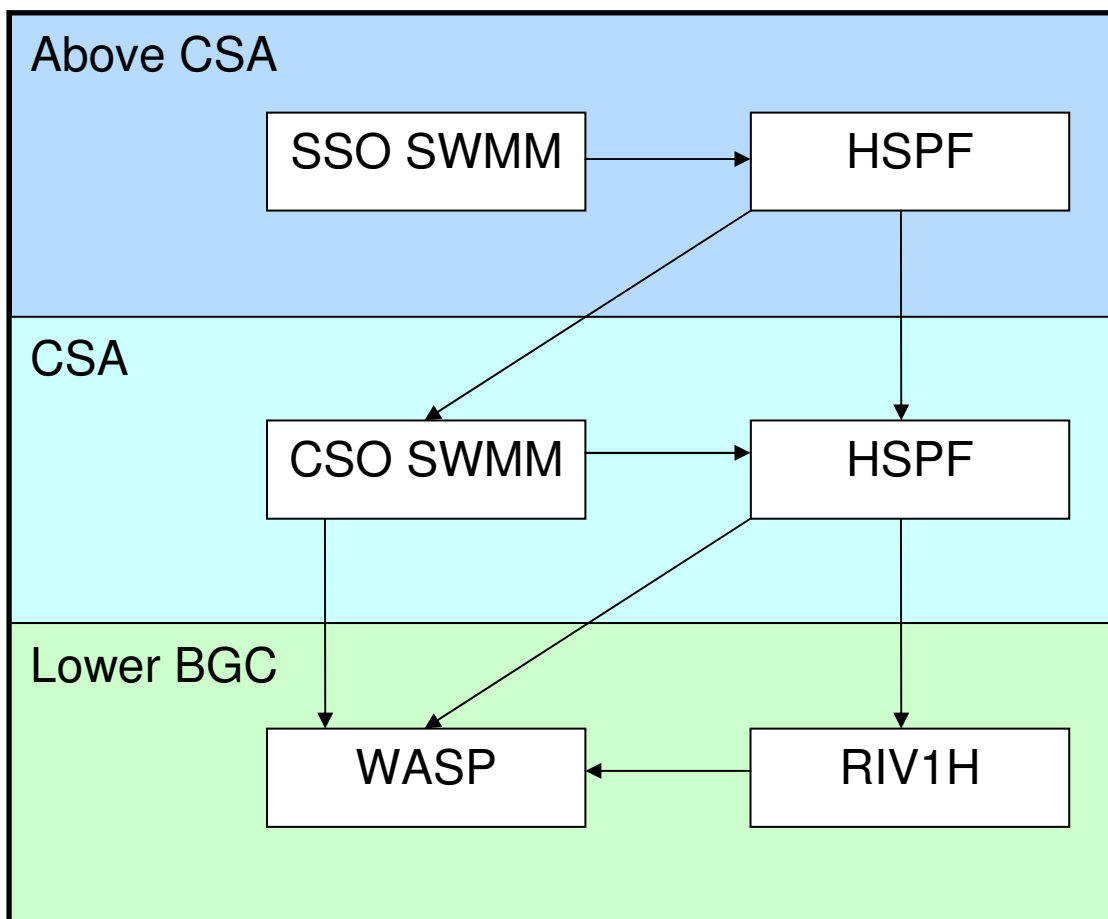


Figure B.1 Schematic of WQT System Components

## **B.2 HSPF**

Runoff and pollutant loading from the land surface and subsurface, as well as transport within stream segments not significantly affected by the Ohio River backwater are simulated with the HSPF model (Bicknell et al., 2001). HSPF is a comprehensive package developed by EPA for simulating water quantity and quality for a wide range of organic and inorganic pollutants from complex watersheds.

In HSPF, a sub-watershed is typically conceptualized as a group of various land uses all routed to a representative stream segment. Several small sub-watersheds and representative streams may be networked together to represent a larger watershed drainage area. Various modules are available and may be readily activated to simulate various processes, both on land and in-stream.

Land processes for pervious and impervious areas are simulated through water budget, sediment generation and transport, and water quality constituents' generation and transport. Hydrology is modeled as a water balance in multiple surface and soil layer storage compartments. Interception, infiltration, evapotranspiration, interflow, groundwater loss, and overland flow processes are considered and are generally represented by empirical equations. Sediment production is based on detachment and/or scour from a soil matrix and transport by overland flow in pervious areas, whereas solids buildup and washoff is simulated for impervious areas. Sediment contributions include agricultural components for land-based nutrient and pesticide processes and a special actions block for simulating management activities. HSPF also simulates the in-stream fate and transport of a wide variety of pollutants, such as nutrients, sediments, tracers, dissolved oxygen/biochemical oxygen demand, temperature, bacteria, and user-defined constituents.

HSPF has been widely reviewed and applied throughout its long history (Hicks, 1985; Ross et al., 1997; Tsihrintzis et al., 1996; Donigian and Huber, 1991). One of the largest applications of the model was the Chesapeake Bay Watershed, as part of the EPA's Chesapeake Bay Program's management initiative (Donigian et al., 1990, 1991). An extensive HSPF bibliography has been compiled to document model development and application (<http://hspf.com/hspfbib.html>).

The HSPF implementation for Beargrass Creek is built upon an existing HSPF model of portions of the watershed. An initial version is documented by Jarrett et al. (1998), and a subsequent version in Jarrett and Schaffer (2003). These efforts achieved partial calibration of hydrology, but were neither fully developed nor calibrated for water quality.

## **B.3 HSPF Hydrologic Parameters**

The hydrology of a watershed is determined by input and property variables such as meteorologic data, topography, soil properties, geology, land use, and evapotranspiration. These characteristics are highly heterogeneous throughout the watershed. In order to account for the distribution of these heterogeneous characteristics, a hydrologic model has been used to simulate watershed characteristics. Because HSPF uses spatially variable input parameters to predict watershed response, Hydrological Response Units (HRU) are used. HRUs are composites of soils, slopes, land use and imperviousness that react in a similar hydrological manner.

Homogeneous areal units are characterized by unique combinations of soils, land use and erosion potential. These homogenous areal units are used to simulate the watershed's hydrodynamic properties.

Each HRU is identified by a three digit number, in which the first digit indicates the land use type, the second digit the soil cluster, and the third digit the precipitation station. For each cluster, a weighted average minimum permeability and the unsaturated zone soil water capacity above the seasonal high water table (LZSN) were calculated. The HRU numbering scheme for pervious lands is shown in Table B.1. For example, a pervious land segment numbered 234 would represent the pervious portion of multi-family residential land use located on soils assigned an LZSN of 3.97 and for which the precipitation data is obtained from the East County Government Center (RG11) station. Effective impervious area was subtracted from each of these classes and grouped as impervious HRUs. The impervious HRUs always have a first digit of 1 and second digit of 9, while the third digit in the number represents the rainfall station, as with the pervious HRUs.

**Table B.1 HRU Identification for Pervious Lands**

Code	1 <sup>st</sup> Digit	2 <sup>nd</sup> Digit		3 <sup>rd</sup> Digit
	Land Use	Original LZSN Estimate (in)	Average Minimum Permeability (in/hr)	Rainfall Station
1	Single family residential	5.45	0.150	RG6: Seneca Park
2	Multi-family residential	9.41	0.184	RG7: Louisville Water Tower
3	Commercial	3.97	0.092	RG8: McMahan Fire Station
4	Industrial	NA	NA	RG11: East County Government Center
5	Public and Semi Public (schools, churches, etc.)	4.09	0.126	RG19: South Fork near the Confluence
6	Parks and cemeteries	10.86	0.261	RG29: MSD Office 3 <sup>rd</sup> St.
7	Single-family residential (Indian Hills and Anchorage areas)	NA	NA	RG33: St. Matthews Fire Station
8	Transportation	NA	NA	NA
9	Vacant	Denotes impervious surfaces		NA

The assignment of pervious and impervious land uses to watershed in the model is summarized in Table B.2

**Table B.2 Model Assignment of Pervious and Impervious Land Uses (acres)**

Land Use	South Fork		Middle Fork		Muddy Fork	Lower Beargrass Creek	
	Direct Drainage	CSO Drainage	Direct Drainage	CSO Drainage	Direct Drainage	Direct Drainage	CSO Drainage
<b><i>Pervious surfaces (acres)</i></b>							
Single family	5392.1	1241	5945.2	754.2	2914.9	11.1	270.8
Multi-family	601.5	156.6	720	143.9	155.9	2.4	93.4
Commercial	856.2	93.6	936	29.3	60.9	8.8	29
Industrial	574.1	53.7	233.3	8.2	8.8	25.7	25.5
Public, semi-public	631.1	84.3	663.5	135.1	131	12.8	62.8
Parks, etc.	909	99.2	1666.8	46.8	522.3	97.4	41.2
Transportation	269.5	46.3	1051.7	31.8	471	74.6	42.6
Vacant	892	47.1	389	13.2	55	8.7	10.1
<b><i>Impervious surfaces (effective impervious area; acres)</i></b>							
Impervious	3094.7	1800	2627.3	1005.9	558.4	35.5	58.3
<b><i>Summary (acres)</i></b>							
Total Area	13220.2	3621.8	14232.8	2168.4	4878.2	277	633.7
Effective Imperviousness	23.4%	49.7%	18.5%	46.4%	11.4%	12.8%	9.2%

The processes for pervious and impervious areas are simulated through water budget, sediment generation and transport, and water quality constituents' generation and transport. Hydrology is modeled as a water balance in multiple surface and soil layer storage compartments. Interception, infiltration, evapotranspiration, interflow, groundwater loss, and overland flow processes are considered and are generally represented by empirical equations. Sediment production is based on detachment and/or scour from a soil matrix and transport by overland flow in pervious areas, whereas solids buildup and washoff are simulated for impervious areas. Sediment contributions include agricultural components for land-based nutrient and pesticide processes and a special actions block for simulating management activities. HSPF also simulates the in-stream fate and transport of a wide variety of pollutants, such as nutrients, sediments, tracers, dissolved oxygen/biochemical oxygen demand, temperature, bacteria, and user-defined constituents.



#### **B.4 Sanitary Sewer Overflows**

SSOs and CSOs are potentially significant sources of fecal coliform and other pollutants in the Beargrass Creek watershed during wet weather periods. The behavior and representation of each is handled differently within the WQT.

SSOs are a direct discharge to a stream segment from the sanitary sewer system. They can result from either the unintentional overflow of the system due to a wet weather event or from the intentional pumping of the system to reduce flooding hazards.

SSO time series inputs to the HSPF model were developed from relationships to storm characteristics using existing SWMM models of the separate sewer system. The MSD SSS hydraulic models predict and analyze the response of the system to various rain events. These models were originally intended to identify restrictions and potential overflows as well as to facilitate remediation. The models have been revised and recalibrated at various points to reflect changes within the system or improvements in computing technology. The models were modified to provide overflow volume, overflow duration, and overflow hydrograph for each SSO within the model. Pumped SSOs are present within the model either as a fully developed pump simulation or as a discharge pipe with an elevation at the recommended pump activation level according to operational documents, where available.

Tetra Tech ran 12 months of continuous simulation (9/2002 through 3/2003 and 11/2000 through 3/2001) with the five existing separate sewer system models. These periods were chosen to maximize the potential for SSOs. Each model ran the month preceding the times of interest to establish accurate antecedent conditions. Several discrete storms were also simulated to provide additional data. These data as well as the storm depth and storm duration were entered into a database or response library.

The very long run times required by the separate sewer system models necessitated a regression model approach based on recommendations made as part of the peer review process. The response library was incorporated into the regression model to predict the performance of each SSO using a “bucket” approach. The capacity of the sewer system node is represented as a bucket with unit storage and fitted parameters for fill and emptying rates as a function of precipitation. The accumulated excess volume is then released at a rate that scales up to a maximum possible rate for the SSO (also a model fit parameter). The resulting regression equations were then convoluted with the 2000-2004 rainfall record to produce SSO time series for input to HSPF. As specified in the QAPP, typical discharge concentrations for Louisville SSOs were combined with the SSO discharge records to generate a timeseries of the discharge for each SSO location. Predicted SSO events were then aggregated to the HSPF sub-basin level for input into the model. Sufficient monitoring is not available to specify time-varying concentrations for SSOs.

This approach for estimating SSO discharge introduces some uncertainty into the HSPF simulations because antecedent hydraulic conditions are not explicitly simulated. In addition many SSOs occur as a result of temporary line blockages, which are not predictable by the current model. Further, not all the SSOs are purely hydraulic in nature, as some pumping of sanitary sewers into surface channels is performed by MSD staff in order to alleviate basement

flooding. Unfortunately, records of such pumped SSOs are incomplete and the models cannot predict the variability of manually activated pumps. Instead, the available records of pumped SSOs are included in the SWMM model output for the separate sewer system that provides the calibration data for the regression model of SSO events as a function of precipitation. All of these issues introduce uncertainty into the SSO time series generation process – likely with the most significant impact on prediction of fecal loads

## **B.5 Combined Sewer Overflows**

CSOs play an important role in both the hydrology and water quality of Beargrass Creek. The WQT addresses this through incorporation of a detailed simulation model of the combined sewer system.

### Model Integration for CSOs

The WQT uses a combination of the HSPF and SWMM models to include the effect of CSOs in the watershed (see Figure B.2 and Figure B.3). CSOs are primarily storm driven discharges and respond to runoff from the area draining to a CSO inlet. The relationship between each CSO drainage area and the HSPF watershed within which it falls is shown in Table B.3. Once the relationship was established, the CSO drainage area polygons were intersected with the revised land use theme. Surface runoff and part of the subsurface discharge from areas falling within each CSO drainage polygon were assumed to drain directly to the CSO system and do not enter the stream system directly. The HSPF model provides flows and pollutant loads for an inlet associated with each CSO drainage polygon, which is transferred to the SWMM model. The land areas outside the CSO drainage polygons drain directly to the stream system, including those portions of the lower Beargrass Creek area that are not served by combined sewers. The SWMM model combines the pollutant loads in stormwater simulated by HSPF with loads from sanitary sewage to predict the pollutant concentrations present in CSOs discharging back to the stream.

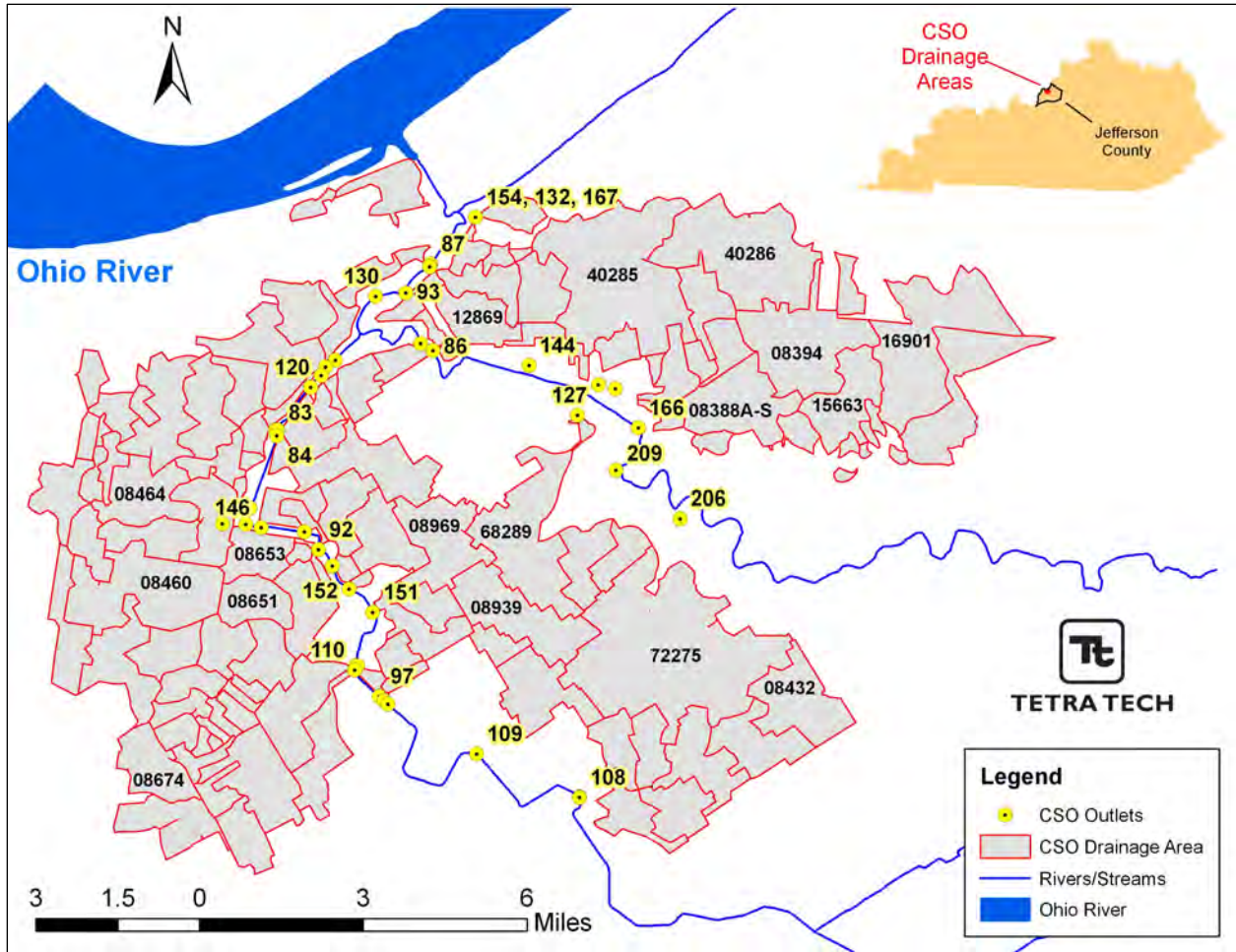
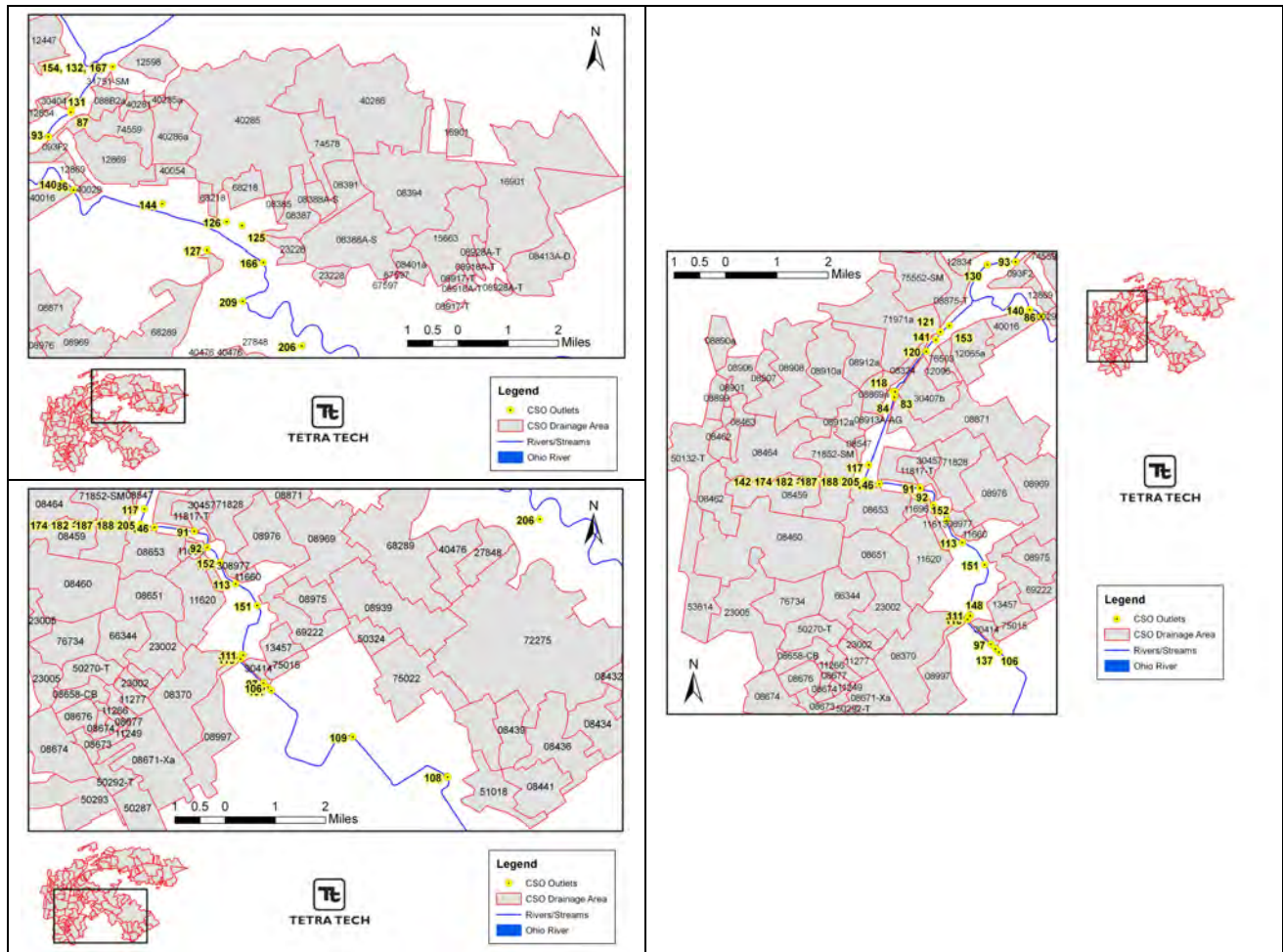


Figure B.2 CSO Drainage Areas



**Figure B.3 CSO Drainage Areas (Detail)**

During initial calibration of the CSO model, the HSPF setup exported only the surface runoff component of the flow to the SWMM model. Subsequent iterations included a portion of the subsurface flow as well to represent the effects of infiltration into the sewer system. This required a series of iterative adjustments to both the HSPF and SWMM models to obtain satisfactory representations of both CSO events and in-stream flows within the CSA.

**Table B.3 CSO Drainages within each HSPF Sub-watershed**

<b>Watershed</b>	<b>CSO Inlet ID</b>
390	8432, 8434, 8436, 8439, 8441, 51018
400	75022
410	8997, 30414, 50324, 75015
500	8370, 8939, 8969, 8975, 8976, 8977, 11613, 11620, 11660, 11696, 11817-T, 13457, 69222, 71828
600	8324, 8547, 08869a, 08890a, 8899, 8901, 8906, 8907, 8908, 08910a, 08912a, 08913A-AG, 12065a, 12096, 30407b, 71971a, 75552-SM, 76503
610	8459, 8460, 8462, 8463, 8464, 8651, 8653, 08658-CB, 08671-Xa, 8673, 8674, 8676, 8677, 11249, 11266, 11277, 23002, 23005, 50132-T, 50287, 50292-T, 50293, 53614, 66344, 71852-SM, 76734, 50270-T
620	8871, 30457
700	08875-T, 088B2a, 093F2, 12598, 12834, 30404, 31751-SM, 40281, 40285, 40285a, 40286, 40286a, 74559, 74578
750	08401a, 08413A-D, 08917-T, 08918A-T, 08928A-T, 15663, 16901, 67597
755	72275
760	23228, 27848, 40476
765	83858387, 08388A-S, 8391, 8394, 68218, 68289
770	40054
780	12869, 40016, 40029
800	12447, 75501

The HSPF and SWMM models use significantly different data formats for data transfer. Two Visual Basic “Bridge Routine” codes were developed to perform the necessary data transformations between HSPF and SWMM and to incorporate software utilities developed for the SWMM system.

Bridge Routine 1 (BR1) uses matrix algebra to multiply the per acre land use export timeseries created by HSPF and the area of each land use by CSO drainage to calculate the total flow and pollutant loading that is input to a SWMM inlet. The BR1 also converts the results from a text format to the binary integer format used by the SWMM system.

The model generates an output timeseries representing the overflows and associated pollutant loads from the system at each CSO location. The resulting timeseries are processed using Bridge Routine 2 (BR2). This set of programs converts the output timeseries to a set of individual text files and writes them to a Watershed Data Management (WDM) file which stores input data for the HSPF model. Each CSO discharge timeseries is written to a specific data location within the WDM file.

The complete HSPF model is then run to predict the effects of CSO events. This second run reads the individual timeseries from the WDM file as direct discharges to the reaches as determined by the GIS CSO location and reach coverages. Table B.4 specifies the modeled CSOs and the reaches that they enter.

### Combined Sewer System Hydraulic Characterization

Most of the work of characterizing the combined sewer system was carried out in conjunction with the development of the original Beargrass Creek SWMM model in 1991-1992. The SWMM EXTRAN block performs dynamic routing of flows throughout the combined sewer system to the outfalls into the receiving water. To accurately represent system, the EXTRAN required extensive input data for the physical structures' characteristics found in the field. The input data for EXTRAN block included the following:

- **Junction:** Invert and Rim elevations, pipe invert offsets, user defined flow (dwf)
- **Conduit;** Shape, size, length, hydraulic roughness (Manning's 'n'), connecting junctions, initial flows, and pipe invert offsets
- **Storage Junction:** Storage volume (surface area over their depth), elevation of spill crest and invert
- **Orifice:** Type of orifice, area, discharge coefficient, and invert elevation
- **Weir:** Type of weir, length, top elevation, crest elevation, discharge coefficient
- **Pumps:** Pump rate and volume

The pipe network was developed from the as-built drawings, construction drawings, and CSO inventory records. The CSO inventory information was used to develop the model framework for the combined sewer overflow structures. When available, as-built drawings were used to develop the model, otherwise the construction drawings were utilized.

In the EXTRAN block most of the real physical structures found in the field were presented but in certain cases it was difficult and not possible to model exact conditions due to limitations of available SWMM parameters. Special modeling consideration was given to determine the best approach for simulating actual conditions. These cases included:

***Odd-shaped Pipes:*** Certain pipe shapes within the CSO service area were not defined within the SWMM parameters. Three of these pipe shapes were encountered, Semi-elliptical, Semi-circular, and Inverted-Egg. In these cases, an equivalent pipe shape and size was used in place of these odd-shaped sewers, which performed hydraulically similar to the field conditions.

**Table B.4 CSO Outlets by HSPF Stream Segment**

Watershed	CSO Outlet
390	73226A-DO & 73226B-DO, 73226B-DO
400	75025-DO
410	08988-DO, 65828-DO, 65836-DO, 75064-DO
500	13461-DO, 30437-DO, 66332-DO, 71817-DO, 71880-DO, 71887-DO, 78001-DO
600	141D6A-DO, 30132-DO, 30135-DO
610	11777-DO, 71865-DO, 71885-DO, 71909-DO
620	084E6B-DO, 08868-DO, 76536-DO
700	12804, 087D2-DO, 30310-DO, 40269-DO, 40604-DO, 72000-DO
755	15195-DO
760	68304-DO, 72267-DO
765	127D4-DO, 68334-DO, BG12202
770	30423-DO
780	23140-DO, 40630-DO
800	TO OHIO RIVER

**Detention Basins:** Runoff from the Kentucky State Fairground is detained in the basin until it overtops the weir and is then discharged through a culvert and into the Upper Dry Run Trunk. This detention basin was simulated by the use of a storage junction and a weir.

**Mechanical Regulators:** Float operated (“tell-taled”) mechanical regulators used to regulate flows between trunk sewer collection lines and combined sewer interceptor lines exist at various

CSOs within the Beargrass Creek basins. Once the interceptor is operating at full capacity, the float regulators close, and no flow is allowed to pass into the interceptor. This scenario was not readily defined within available SWMM parameters. Instead, the combination of a generally small connecting pipe and flap gate was used to represent float regulators.

**Main Diversion Structure:** The main diversion structure (MDS) collects flows from the Ohio River Interceptor, the Southern Outfall, and the Western Interceptor and conveys these flows directly to the Morris Forman Wastewater Treatment Plant (MFWTP). During periods of wet weather, the MFWTP is only capable of handling a certain amount of flow; this flow enters MFWTP from both the Ohio River Interceptor and the Southwestern Branch Interceptor. During storm events, flows within the Southern Outfall frequently reach levels of 500 to 600 cfs, which exceed the plant capacity of approximately 350 cfs. This produces backwater within the Ohio River Interceptor and Western Interceptor. In an attempt to represent the field conditions, each model affected by potential backwater conditions at the MDS was given special consideration. In effect, this involved including the diversion structure configuration in each model that terminated there and inputting the appropriate backwater conditions as recorded by the flow meters located around the structure for each model simulation.

**Pump Stations:** EXTRAN was capable of modeling three types of pumps:

1. Off-line pump station with a wet well in which the rate of pumping depends upon the volume of water in the wet well.
2. On-line pump station that pumps according to the level of the water surface at the junction being pumped.
3. Either an on-line or off-line pump that pumps according to the head difference over the pump. This type uses a three-point pump curve.

The pump stations constructed within the CSO models were configured with the off-line pump station option because it most closely represents the actual operation of the pump stations existing in the MSD area. Available pump information and flow data were reviewed for each of the pump stations modeled. Maximum and minimum flows in the data were input as the high and low pump rates, respectively. The average flow rates in the data were input as the medium pumping rates.

As part of regular model maintenance, O'Brien and Gere incorporated many improvements and changes within the combined sewer system area. The following information documents the changes that were incorporated into the WQT model. These updates were completed as of April 2002.

1. Nightingale Pump Station reconfiguration
2. Buchanan Pump Station Improvements
3. On-line Storage with RTC (Sneads Branch Relief)
4. Letterle Pump Station & CSO 145 Elimination
5. CSO 88 Elimination (Sewer Separation)
6. CSO 147 Elimination (Sewer Separation)



Combined Sewer System Water Quality Representation

Water quality in the CSS results from the mixing of two sources: dry weather sanitary flows and wet weather storm runoff. While the wet weather flows and loads are provided by the HSPF model, the water quality concentrations during dry weather flow were directly assigned within the Hydraulic module in SWMM as part of dry weather flow inputs and as part of the dry weather concentration. While some in-system data have been obtained, these data are generally insufficient for a detailed calibration of water quality in the combined sewer system. To start the model calibration process, dry weather sanitary flow concentrations were assigned, based on MSD monitoring and literature values, as specified in the Quality Assurance Project Plan (QAPP) (Tetra Tech, 2005) and shown in Table B.5.

**Table B.5 Recommended Dry Weather Concentrations for Sanitary Flow**

	<b>BOD5 (mg/L)</b>	<b>Fecal Coliform (#/100 mL)</b>	<b>DO (mg/L)</b>	<b>Ammonia-N (mg/L)</b>	<b>TSS (mg/L)</b>
Louisville MSD – Morris Foreman influent	299.7	No data	No data	12.3	331.1
Louisville MSD – West County influent	205.4	No data	No data	17.4	244.6
Medium concentration (Metcalf & Eddy, 1991)	220.0	$10^7$ - $10^8$ *	No data	25.0	220.0
Strong concentration (Metcalf & Eddy, 1991)	400.0	$10^7$ - $10^9$ *	No data	50.0	350.0
Untreated dry weather SSOs (USEPA, 2004)	88-451	$10^6$ - $10^9$	No data	11.4-61	118-487
Recommended (Tetra Tech, 2005)	250.0	$10^8$	0	25.0	250.0

Note: \*M&E reports total coliform rather than fecal coliform

To start the calibration of the HSPF model, fixed concentrations were also initially assigned to CSOs (Table B.6). After initial calibration, the fixed CSO concentrations were replaced by concentrations predicted by the CSO model, and final calibration of water quality in HSPF and SWMM proceeded iteratively.

**Table B.6 Initial Wet Weather Concentrations for CSOs**

	<b>BOD5 (mg/L)</b>	<b>Fecal Coliform (#/100 mL)</b>	<b>DO (mg/L)</b>	<b>Ammonia-N (mg/L)</b>	<b>TSS (mg/L)</b>
Louisville MSD monitoring data	54.5	185,110	No data	1.6	174.1
National median values (USEPA, 2004)	43.0	215,000	No data	3.6	127.0
Recommended (Tetra Tech, 2005)	50.0	200,000	3.0	25.0	250.0

In addition to sewage and stormwater, the water quality loads generated by Significant Industrial Users (SIUs) were assigned as direct input within the SWMM model at specific manhole locations (Table B.7).

**Table B.7 Significant Industrial Users Represented in CSS Model**

MH#	Industry	Flow	Concentrations	
		CFS	TSS	BOD
12834	Swift & Company Loc 2	0.83	976	1,367
12834	Swift & Company	0.59	1,814	2,357
13308	Forth Technologies Bergman	0.07	331	1,041
45899	Baptist Healthcare System East	0.34	148	191
45899	Norton Healthcare Suburban	0.11	210	190
51175	Willamette Industries Inc	0.16	1,972	1,363
51175	Inland Paperboard & Packaging	0.06	806	625
08792-T	Fischer Packing Company	0.65	131	301
71971a	Kent Feeds Inc	0.05	714	4,510

## B.6 Ohio River Boundary

Flow in the lower portion of Beargrass Creek is controlled by stage in the McAlpine Pool of the Ohio River, and reversing flow occurs in the lower reaches. Therefore, both stage and water quality must be specified at this boundary.

Stage data at the mouth of Beargrass Creek are obtained from US Army Corps of Engineers records at the McAlpine Upper gage (RM 607), located on the upstream end of the lock at McAlpine Dam. This station reports stage relative to a datum of 408 ft MSL, which was corrected to the RIV1 project datum to provide elevations relative to a base invert elevation of 414 ft MSL at the mouth of Beargrass Creek. Lacking other data, it was necessary to make a level pool assumption between McAlpine Lock and the mouth of Beargrass Creek. This assumption is generally reasonable because flow in the river is strongly controlled, but may occasionally underestimate stage at the mouth of Beargrass Creek under extreme high flow conditions.

Water quality boundary conditions in the Ohio River were estimated from Ohio River Valley Water Sanitation Commission (ORSANCO) monitoring. The fecal coliform boundary condition was based on weekly (during the recreation season) 2001-2006 data collected by ORSANCO at River Mile 608.7. Other water quality parameters are taken from ORSANCO bimonthly monitoring at the Louisville Water Company water tower (River Mile 600.6). Wet weather sampling in particular is limited. In both cases, there are not sufficient data to form time series of concentrations at the Ohio River boundary. Based on discussions with LimnoTech modelers who are creating a simulation model of the Ohio River, concentrations in the Ohio main stem are not strongly correlated to flow, so average concentrations are used to specify the boundary condition (Table B.8). In reality, dynamic water quality conditions exist in the Ohio River; however, effects on water quality in Beargrass Creek are expected to be small because the amount of reverse flow penetrating upstream into the lower Beargrass is predicted to be small and infrequent. Future completion of an Ohio River model would allow a more detailed specification of the boundary conditions.

**Table B.8 Specification of Ohio River Boundary (Average Condition)**

Parameter	Concentration	Parameter	Concentration
BOD5	3.88 mg/L	Dissolved Oxygen	7 mg/L
Organic N	0.671 mg/L	Fecal Coliform	80 #/100 mL
NH <sub>3</sub> -N	0.067 mg/L	Sand	0 mg/L
NO <sub>3</sub> -N	1.246 mg/L	Silt	35.03 mg/L
Organic P	0.156 mg/L	Clay	23.35 mg/L
PO <sub>4</sub> -P	0.052 mg/L		

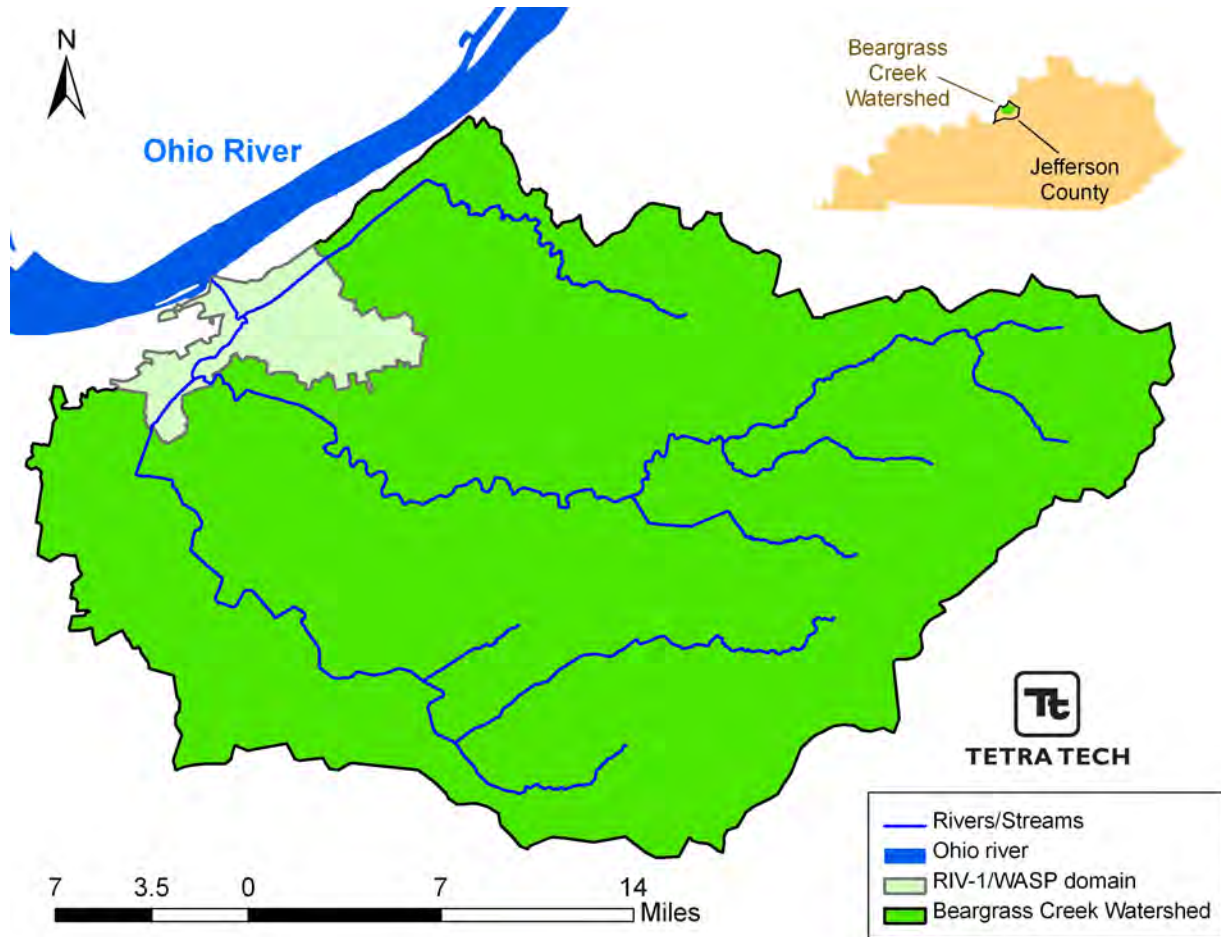
### B.7 RIV-1 Model

Within the backwater sections of Beargrass Creek adjacent to the Ohio River, the receiving water model needs to represent hydrodynamic behavior resulting from mass/volume input upstream with a variable head boundary downstream representing stage in the Ohio River. Reversing flows are documented in this section of the creek. Representation of the backwater effect and reversing flows requires conservation of momentum as well as mass. Because HSPF's reach simulation cannot address reversing flows it is not suitable for application to this section of Beargrass Creek. Instead, stream hydrology within this section (Figure B.4) is simulated using the RIV-1 model, with water quality represented by WASP.

While reversing flows occur in lower Beargrass Creek, the waterbody remains relatively narrow and shallow. As a result, a one-dimensional modeling application is sufficient. A one-dimensional model is also appropriate to the available monitoring and boundary condition data, which do not provide any representation of lateral or vertical variability.

The RIV1 model was developed by the U.S. Army Corps of Engineers Waterways Experiment Station as CE-QUAL-RIV1 (Environmental Laboratory, 1995). It is a one-dimensional cross-sectionally averaged hydrodynamic and water quality model suitable for application to unsteady flow simulation. The original model was subsequently updated for the Georgia Environmental Protection Division (Martin and Wool, 2002) and is now supported by USEPA Region 4 (<http://www.epa.gov/ATHENS/wwqtsc/html/epd-riv1.html>). The updated version, known as EPD-RIV1 (v. 1.1) provides pre- and post-processing capabilities, as well as enhancements and improvements to the original model code, and was chosen for use in this project.

The RIV1 system contains a linked hydrodynamic model (RIV1H) and water quality model (RIV1Q). Only the hydrodynamic portion is used for Beargrass Creek, as described in the next section.



**Figure B.4 RIV-1/WASP Modeling Domain**

## B.8 WASP

Initial plans for the WQT called for simulation of water quality in lower Beargrass Creek using the RIV1Q companion model to RIV1H. On page 12 of the modeling QAPP the following is stated under Task 2d:

*The lower sections of Beargrass Creek can be highly influenced by backwater effects from the Ohio River. For this reason, the WQT will be modified to include the EPD-RIV1 version of the U.S. Army Corps of Engineers' CE-QUAL-RIV1 model to simulate the complex hydrology of these reaches. This version of the model is selected due to its enhanced input/output routines and post-processing capabilities. Nutrients, dissolved oxygen, and fecal coliform will be simulated using the EPD-RIV1 model for the lower sections of Beargrass Creek extending from the mouth of Beargrass Creek upstream to the confluence of the South and Middle Forks and for the section of Muddy Fork from its confluence with the Middle Fork upstream to the crossing of Indian Hills Trail.*

Selection of the EPD-RIV1 model was based foremost on its ability to handle reversing flows in the hydrodynamic component (RIV1H), as well as its integral linkage to a companion water quality model (RIV1Q).

At the time that the QAPP was prepared, RIV1Q (unlike RIV1H) did not work with reversing flows; however, we were informed by the developers that this upgrade would be completed shortly. Unfortunately, this upgrade has not been completed. Therefore, it is not possible to use the water quality component of EPD-RIV1 (RIV1Q) for the timely completion of the Beargrass Creek project.

In addition to RIV1Q, EPD-RIV1H also provides an automated interface to the WASP model (Wool et al., 2003). WASP is a USEPA-supported, general-purpose modeling system for assessing the fate and transport of conventional and toxic pollutants in surface waterbodies, including nutrients, dissolved oxygen, and pathogens. The model simulates time-varying processes of advection and dispersion, considering point and diffuse mass loading, and boundary exchange. Most importantly, the model is not limited in its ability to simulate transport in response to reversing flows. WASP has been used in the development of hundreds of TMDLs (and indeed has a much broader application base than RIV1), and is actively supported by USEPA Region 4.

Based on these considerations, Tetra Tech deemed that it was appropriate to substitute WASP for RIV1Q for water quality simulation in the lower portions of Beargrass Creek. Several modifications were made to the WASP code to meet needs of this project (which necessitated using the DOS-based WASP5 code, rather than the WASP7 executable currently supported by USEPA, for which the code is not publicly available). The modifications include the following:

- The code was modified to allow setting a time step that is less than the intrinsic time step of the external hydrodynamic file. This allows setting a shorter time step in the WASP model during brief periods of dynamic flows that would otherwise cause model instability. When the WASP time step is less than the hydrodynamic time step, the flows in the external hydrodynamic file are assumed to be constant across the time step.
- The code was modified to allow reading tributary boundary conditions from an external file.

The WASP model is driven by the hydrodynamic output of RIV1. For developing the pathogen TMDL, (WASP-TOXI) was implemented to simulate both sediment and fecal coliform bacteria.

**APPENDIX C: HYDROLOGIC CALIBRATION/VALIDATION  
OF THE WQT**

## C.1 Initial Hydrologic Calibration

Calibration of the HSPF model is a sequential process, beginning with hydrology, followed by the movement of sediment, and chemical water quality. Hydrologic calibration uses the standard operating procedures for the model described in Donigian et al. (1984) and Lumb et al. (1994).

The hydrologic simulation is built upon an existing HSPF model of portions of the watershed. An initial version is documented by Jarrett et al. (1998), and a subsequent version in Jarrett and Schaffer (2003). Tetra Tech was provided the 2003 model; however, this turned out to contain parameters that had been randomized on an individual HRU basis, making further progress difficult. As a result, a more traditional approach of using fixed parameter values for specific soil-landuse combinations, as contained in the 1998 model.

While both the 1998 and the 2003 models were claimed to be acceptably calibrated, neither met the acceptance criteria specified in the QAPP for hydrologic modeling when applied to the full model simulation period. As a result, significant further calibration was needed.

In general, the model of Jarrett et al. (1998) provided the starting point for adjustments to achieve calibration. Two of the key hydrologic parameters were initially set based on soil survey information (Zimmerman et al., 1966): the lower-zone nominal storage capacity (LZSN) and the infiltration capacity (INFILT). As described by Jarrett et al., LZSN was estimated for each soil polygon by multiplying the available water capacity by the depth to the seasonally high water table, while INFILT was estimated as the area weighted average of the minimum soil layer permeability reported in the soil survey. This provides a good starting point; however, neither of these parameters in HSPF has the exact physical meaning attributed to it from the soil survey; rather, they are indices of nominal capacity. Jarrett and Schaffer (2003) recognized this, and took the approach of adjusting the original soil-derived parameters downward to achieve better agreement with observations.

Jarrett et al. (1998) used a K-means clustering analysis to group the initial identification of 23,713 polygons representing unique land use, soil, and elevation values into six clusters, subsequently reduced to five clusters. The LZSN and INFILT values were area weighted for each of these clusters. Tetra Tech retained the original soil grouping (and extended it to Muddy Fork) however, the original parameter values were scaled during calibration.

The recalibration made use of HSPEXP (Lumb et al., 1994), an expert system for the hydrologic calibration of HSPF. Final values of LZSN were set at about 60 percent of the soil derived values, while INFILT was set to about 16 percent of the soil-derived values (Table C.1). The first criterion for adjusting INFILT was obtaining a reasonable match to storm peak flows. The large reduction needed in this parameter is expected, as INFILT is neither a maximum rate nor an infiltration capacity term, and is generally much less than published infiltration rates (USEPA, 1999). The final values fall in the range recommended in Basins Technical Note 6 (USEPA, 1999).

**Table C.1 Final Values for LZSN and INFILT Parameters**

Soil Cluster	LZSN (in)	INFILT (in/hr)
1	4.70	0.088
2	7.00	0.102
3	2.75	0.056
4	Not used	Not used
5	3.60	0.039
6	8.20	0.11

A third key parameter controlling the water balance on pervious lands is the monthly pattern of lower-zone evapotranspiration opportunity, LZETP. Jarrett et al. (1998) originally set the annual average value as the sum of the fractional area of tree cover within each polygon. The use of these values appeared to yield too much evapotranspiration and the final values were scaled down accordingly. Final summer maximum values range from 0.26 to 0.40 – somewhat lower than typically used, but likely incorporating an implicit correction factor relative to the calculated Jensen PET.

For baseflows, the rate of groundwater recession (AGWRC) is a key parameter. AGWRC was initially set based on hydrograph analysis; however, it was found that a much better fit was obtained by setting a non-linear recession rate using the KVAR Y parameter set at 1.72 combined with an AGWRC value of 0.985.

The parameter DEEPFR represents the fraction of infiltrating water that is “lost” to the system. Typically, this is assumed to represent transmission to deep aquifers. However, the sewer system modeling assumes that there is significant infiltration into the sanitary sewer system. While infiltration into the combined sewer system is explicitly represented by the HSPF model, infiltration into the sanitary sewer system is not. It is therefore important to specify a non-zero value of DEEPFR to avoid double counting of this water. A value of 5.5 percent provided good results during calibration. This value probably represents a combination of net infiltration to the sewer system and actual losses to deep groundwater, balanced by the effect of non-meteorological inputs of water that occur when publicly supplied water is used for lawn irrigation. Initial values of other hydrologic parameters were set in accordance with the ranges recommended in USEPA (1999).

Four USGS flow gages are available for hydrologic calibration (Table C.2). Three of them are upstream of the CSA, one each on South Fork, Middle Fork, and Muddy Fork. A fourth gage is located within the CSA on South Fork.



**Table C.2 Hydrology Comparison Locations**

<b>Flow Monitoring Location</b>	<b>HSPF Reach ID</b>
USGS03292500	300
USGS03292550	610 (below CSO area)
USGS03293000	740
USGS03293530	920

Hydrologic calibration proceeded sequentially, beginning with the three stations above the CSA. The calibrated model was then used to generate stormwater input to the SWMM CSO model. The CSO output was then brought back into the HSPF model to finalize calibration on the gage within the CSA.

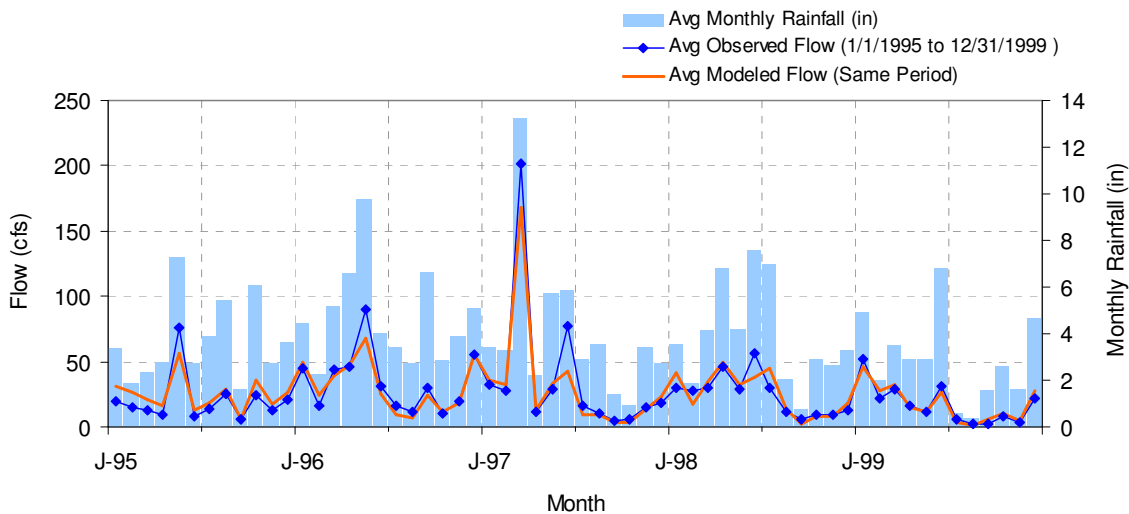
## **C.2 Hydrology Upstream of CSA**

Flows at stations 03292500 on South Fork and 03293000 on Middle Fork have long periods of record and can be thoroughly calibrated and validated. The period covering 1995-1999 was used for model calibration, while 2000-2004 was used as a validation test.

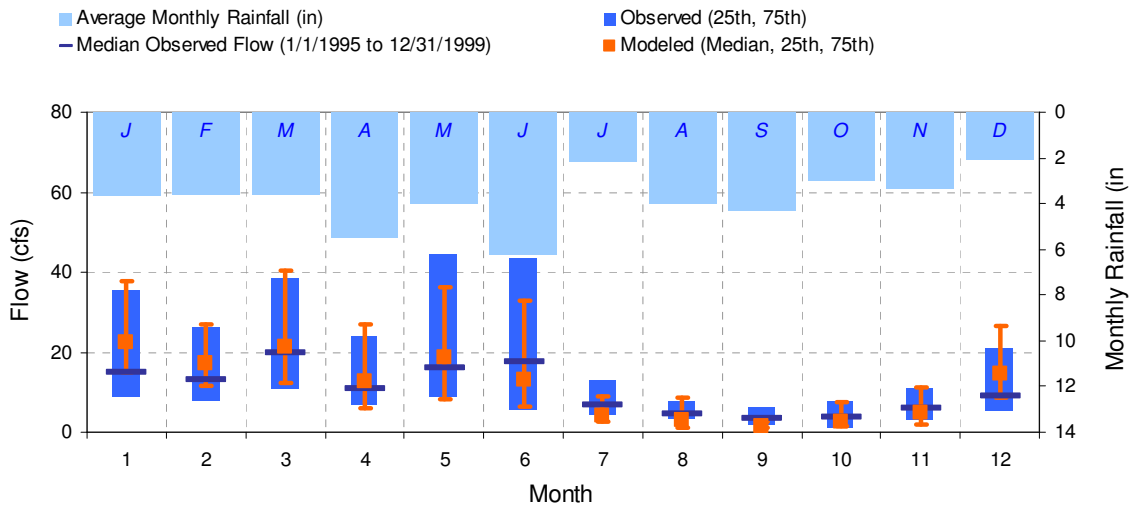
Calibration results for Station 03292500 on the South Fork above the CSA (at Trevilian Way) are shown in Table C.3 and Figures C.1 through C.3. The model meets all the statistical criteria specified in the QAPP, although there are some discrepancies in the flow-duration curve. Results for the validation period are shown in Table C.4 and Figures C.4 through C.6. The validation period is similar to the calibration period and all statistical criteria are again met with one exception, summer storm volume. Closer examination of the data shows a discrepancy in summer storm volume due to a single large event in September 2002 (Figure C.7). The available rain gauges are likely, not be representative of the integrated precipitation depth on the watershed due to the severity of that storm event. As a result, this deviation from the QAPP is not a significant problem for use of the model.

**Table C.3 Hydrologic Calibration, South Fork Beargrass Creek above CSA**

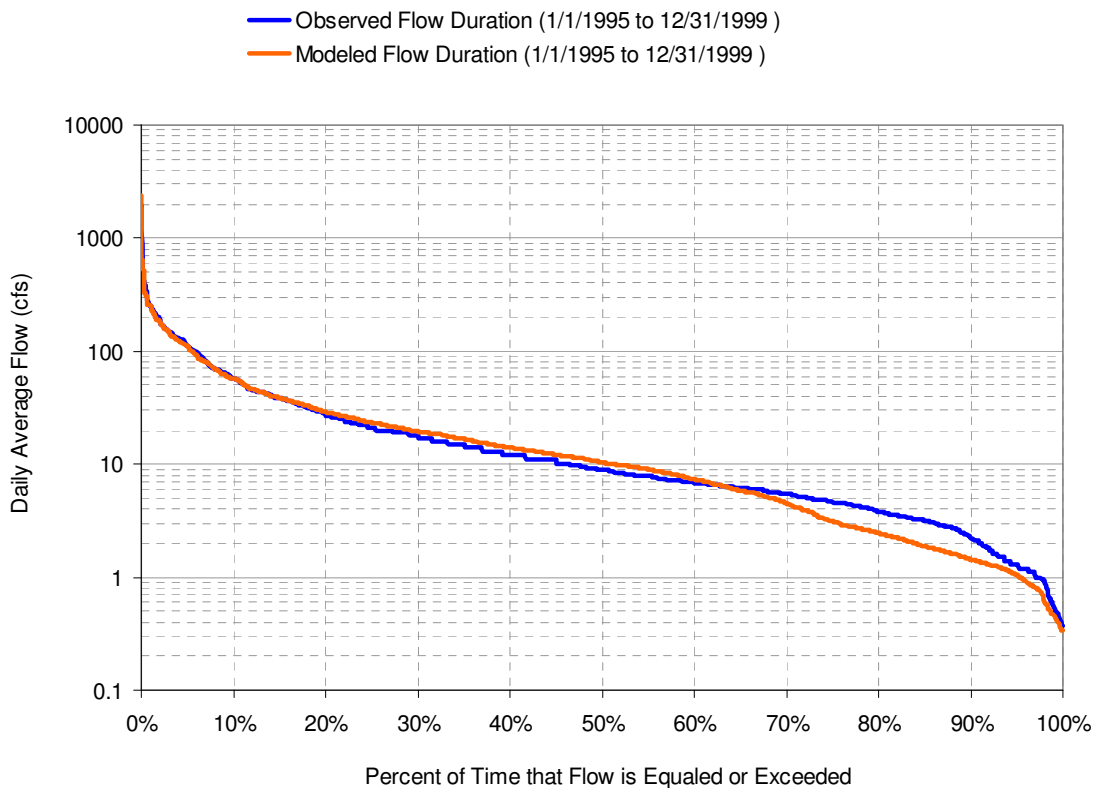
HSPF Simulated Flow		Observed Flow Gage	
<b>REACH OUTFLOW FROM SUBBASIN 300</b>		<b>USGS 03292500 SOUTH FORK BEARGRASS CREEK AT LOUISVILLE, KY</b>	
5-Year Analysis Period: 1/1/1995 - 12/31/1999 Flow volumes are (inches/year) for upstream drainage area		Jefferson County, Kentucky Hydrologic Unit Code 05140101 Latitude 38°12'39", Longitude 85°42'07" NAD27 Drainage area 17.20 square miles	
Total Simulated In-stream Flow:	<b>7.30</b>	Total Observed In-stream Flow:	<b>7.42</b>
Total of simulated highest 10% flows:	<b>4.17</b>	Total of Observed highest 10% flows:	<b>4.41</b>
Total of Simulated lowest 50% flows:	<b>0.58</b>	Total of Observed Lowest 50% flows:	<b>0.64</b>
Simulated Summer Flow Volume ( months 7-9):	<b>0.85</b>	Observed Summer Flow Volume (7-9):	<b>0.89</b>
Simulated Fall Flow Volume (months 10-12):	<b>1.32</b>	Observed Fall Flow Volume (10-12):	<b>1.14</b>
Simulated Winter Flow Volume (months 1-3):	<b>2.88</b>	Observed Winter Flow Volume (1-3):	<b>2.78</b>
Simulated Spring Flow Volume (months 4-6):	<b>2.25</b>	Observed Spring Flow Volume (4-6):	<b>2.62</b>
Total Simulated Storm Volume:	<b>4.62</b>	Total Observed Storm Volume:	<b>4.72</b>
Simulated Summer Storm Volume (7-9):	<b>0.62</b>	Observed Summer Storm Volume (7-9):	<b>0.56</b>
<i>Errors (Simulated-Observed)</i>	<i>Error Statistics</i>	<i>Recommended Criteria</i>	
Error in total volume:	-1.67	10	
Error in 50% lowest flows:	-8.79	10	
Error in 10% highest flows:	-5.58	15	
Seasonal volume error - Summer:	-3.61	20	
Seasonal volume error - Fall:	15.91	20	
Seasonal volume error - Winter:	3.45	20	
Seasonal volume error - Spring:	-14.10	20	
Error in storm volumes:	-2.17	20	
Error in summer storm volumes:	10.92	20	



**Figure C.1 Observed and Modeled Flows, Calibration Period South Fork Beargrass Creek above CSA**



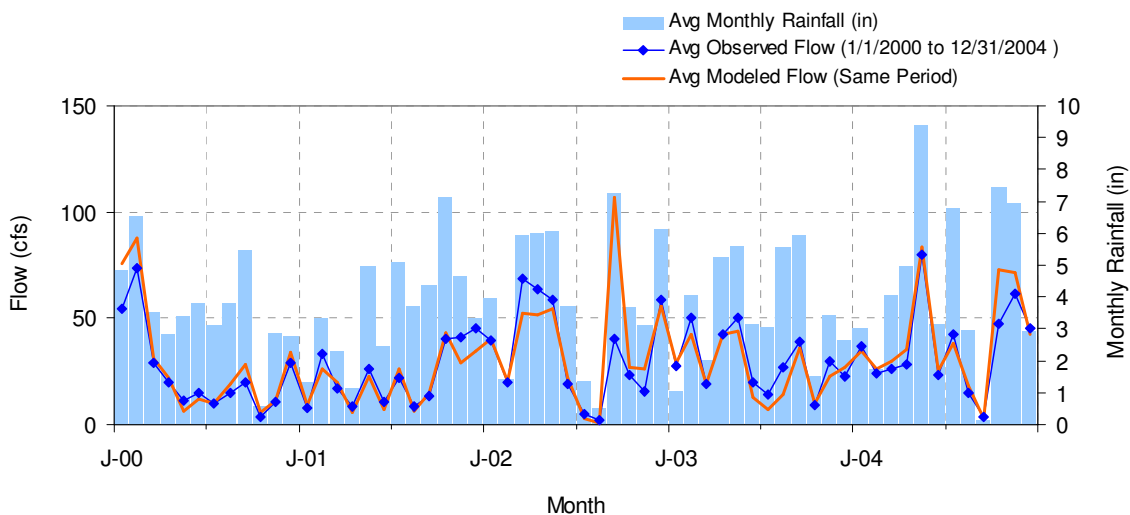
**Figure C.2 Seasonal Flow Pattern, Calibration Period, South Fork Beargrass Creek above CSA**



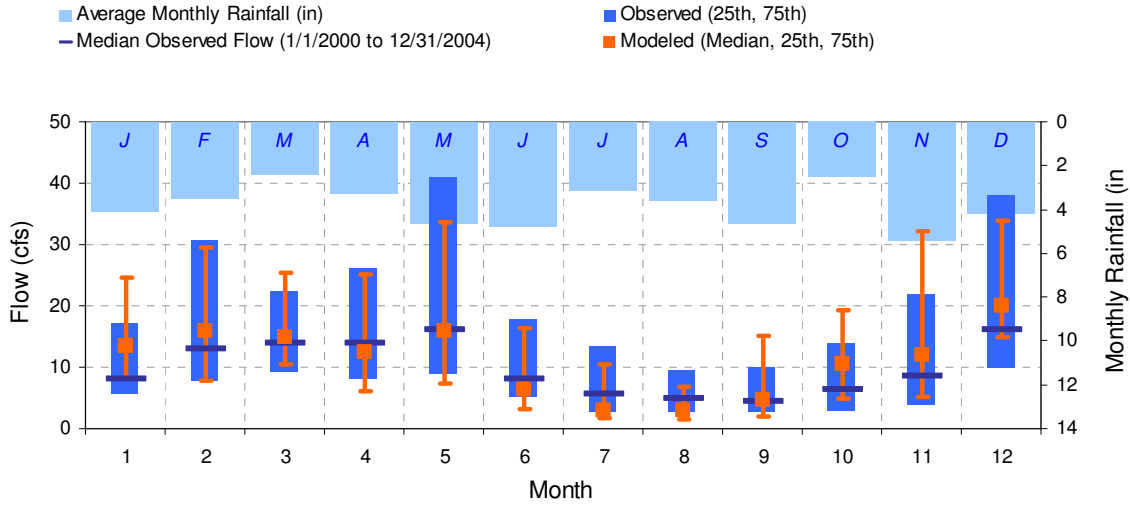
**Figure C.3 Flow Duration Curve, Calibration Period, South Fork Beargrass Creek above CSA**

**Table C.4 Hydrologic Validation, South Fork Beargrass Creek above CSA**

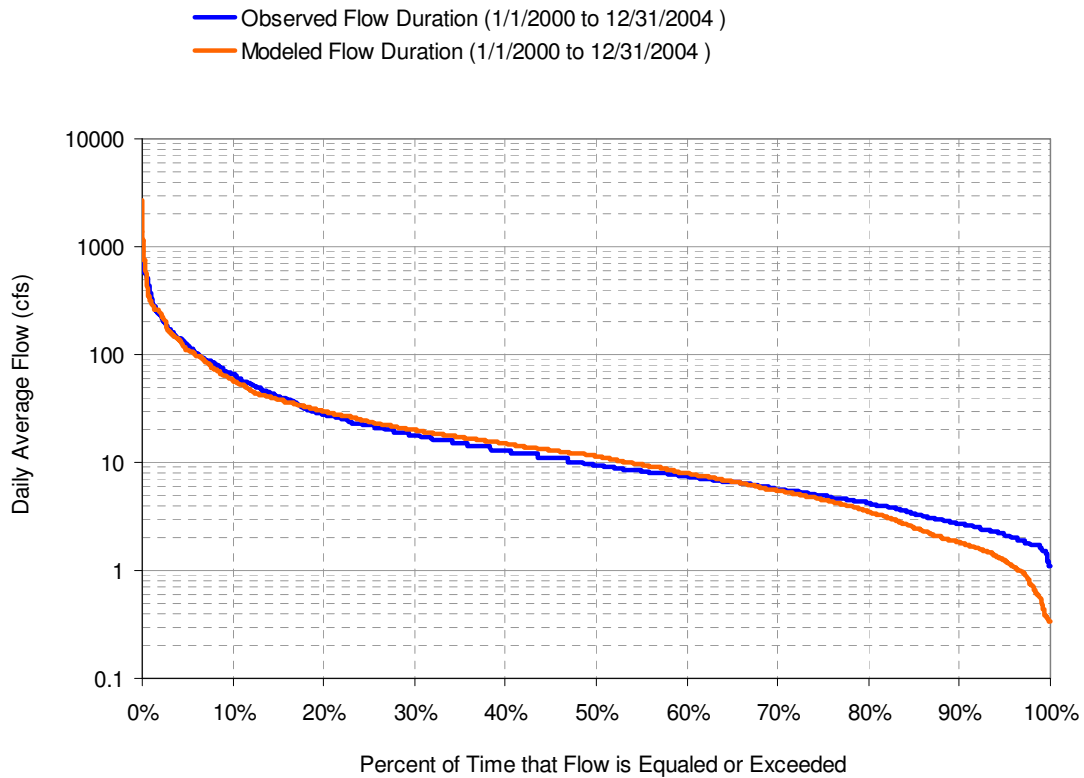
HSPF Simulated Flow		Observed Flow Gage	
<b>REACH OUTFLOW FROM SUBBASIN 300</b>		<b>USGS 03292500 SOUTH FORK BEARGRASS CREEK AT LOUISVILLE, KY</b>	
5-Year Analysis Period: 1/1/2000 - 12/31/2004 Flow volumes are (inches/year) for upstream drainage area		Jefferson County, Kentucky Hydrologic Unit Code 05140101 Latitude 38°12'39", Longitude 85°42'07" NAD27 Drainage area 17.20 square miles	
Total Simulated In-stream Flow:	<b>8.44</b>	Total Observed In-stream Flow:	<b>8.12</b>
Total of simulated highest 10% flows:	<b>5.16</b>	Total of Observed highest 10% flows:	<b>4.91</b>
Total of Simulated lowest 50% flows:	<b>0.68</b>	Total of Observed Lowest 50% flows:	<b>0.70</b>
Simulated Summer Flow Volume ( months 7-9):	<b>1.53</b>	Observed Summer Flow Volume (7-9):	<b>1.28</b>
Simulated Fall Flow Volume (months 10-12):	<b>2.38</b>	Observed Fall Flow Volume (10-12):	<b>2.25</b>
Simulated Winter Flow Volume (months 1-3):	<b>2.48</b>	Observed Winter Flow Volume (1-3):	<b>2.40</b>
Simulated Spring Flow Volume (months 4-6):	<b>2.06</b>	Observed Spring Flow Volume (4-6):	<b>2.19</b>
Total Simulated Storm Volume:	<b>5.63</b>	Total Observed Storm Volume:	<b>5.43</b>
Simulated Summer Storm Volume (7-9):	<b>1.24</b>	Observed Summer Storm Volume (7-9):	<b>0.97</b>
<i>Errors (Simulated-Observed)</i>	<i>Error Statistics</i>	<i>Recommended Criteria</i>	
Error in total volume:	4.00	10	
Error in 50% lowest flows:	-3.16	10	
Error in 10% highest flows:	5.11	15	
Seasonal volume error - Summer:	19.21	20	
Seasonal volume error - Fall:	5.85	20	
Seasonal volume error - Winter:	3.43	20	
Seasonal volume error - Spring:	-6.18	20	
Error in storm volumes:	3.62	20	
Error in summer storm volumes:	27.91	20	



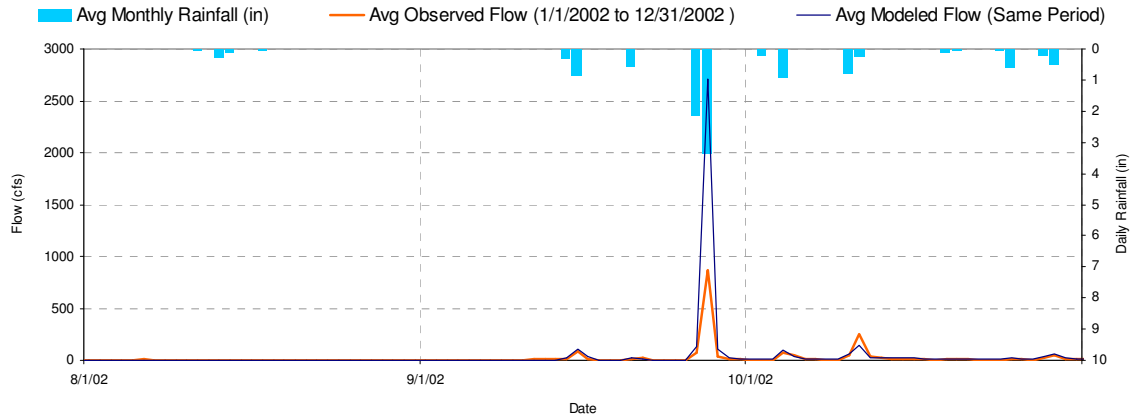
**Figure C.4 Observed and Modeled Flows, Validation Period, South Fork Beargrass Creek above CSA**



**Figure C.5 Seasonal Flow Pattern, Validation Period, South Fork Beargrass Creek above CSA**



**Figure C.6 Flow Duration Curve, Validation Period, South Fork Beargrass Creek above CSA**

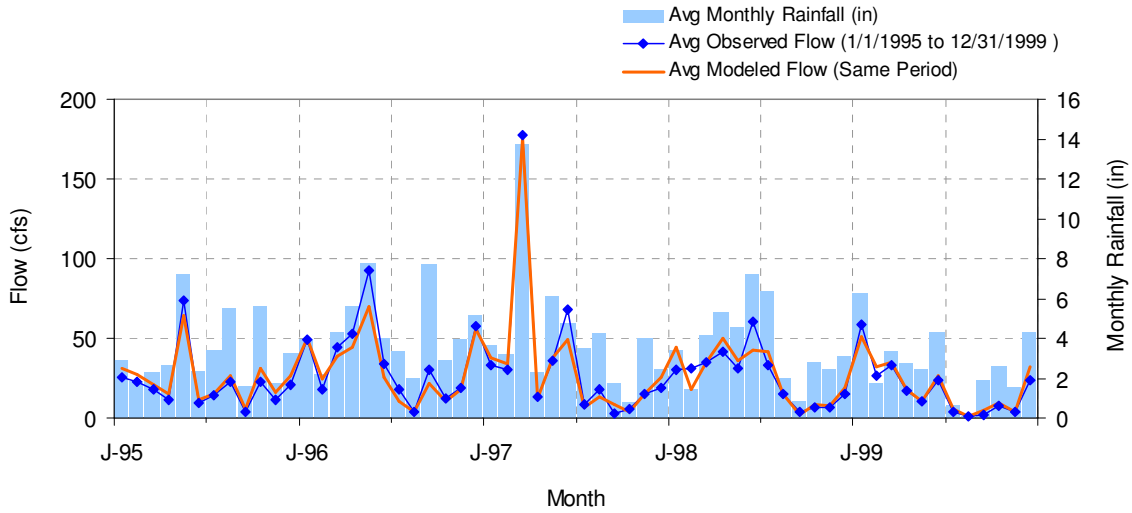


**Figure C.7 Detail of September 2002 High Flow Event**

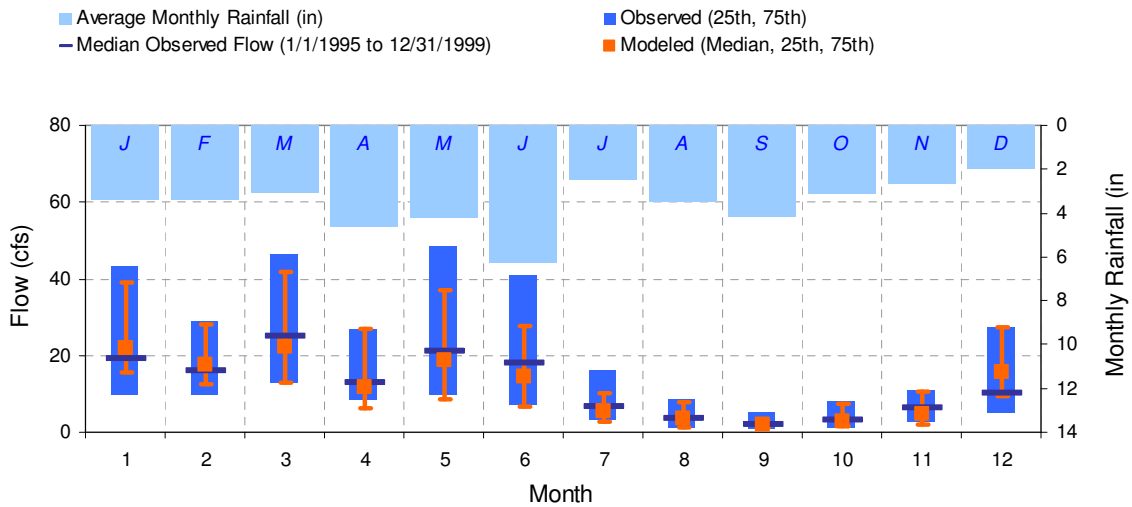
Calibration results for Middle Fork are shown in Table C.5 and Figures C.8 through C.10; validation results are shown in Table C.6 and Figures C.11 through C.13. All acceptance criteria specified in the QAPP are met in both the calibration and validation periods.

**Table C.5 Hydrologic Calibration, Middle Fork Beargrass Creek above CSA**

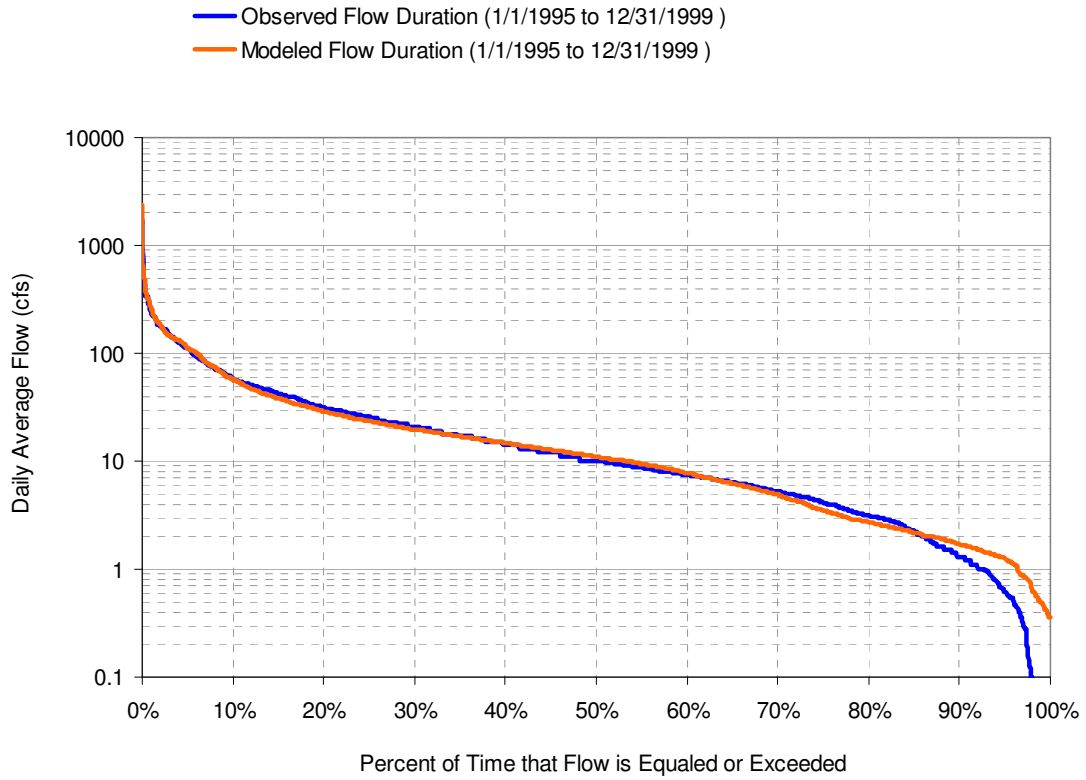
HSPF Simulated Flow		Observed Flow Gage	
<b>REACH OUTFLOW FROM SUBBASIN 740</b>		<b>USGS 03293000 M FK BEARGRASS CR AT OLD CANNONS LN AT LOUISVILLE,</b>	
5-Year Analysis Period: 1/1/1995 - 12/31/1999 Flow volumes are (inches/year) for upstream drainage area		Jefferson County, Kentucky Hydrologic Unit Code 05140101 Latitude 38°14'14", Longitude 85°39'53" NAD27 Drainage area 18.90 square miles	
Total Simulated In-stream Flow:	<b>7.53</b>	Total Observed In-stream Flow:	<b>7.54</b>
Total of simulated highest 10% flows:	<b>4.33</b>	Total of Observed highest 10% flows:	<b>4.22</b>
Total of Simulated lowest 50% flows:	<b>0.63</b>	Total of Observed Lowest 50% flows:	<b>0.61</b>
Simulated Summer Flow Volume ( months 7-9):	<b>0.85</b>	Observed Summer Flow Volume (7-9):	<b>0.84</b>
Simulated Fall Flow Volume (months 10-12):	<b>1.31</b>	Observed Fall Flow Volume (10-12):	<b>1.15</b>
Simulated Winter Flow Volume (months 1-3):	<b>3.01</b>	Observed Winter Flow Volume (1-3):	<b>2.91</b>
Simulated Spring Flow Volume (months 4-6):	<b>2.36</b>	Observed Spring Flow Volume (4-6):	<b>2.64</b>
Total Simulated Storm Volume:	<b>4.71</b>	Total Observed Storm Volume:	<b>4.54</b>
Simulated Summer Storm Volume (7-9):	<b>0.60</b>	Observed Summer Storm Volume (7-9):	<b>0.56</b>
<i>Errors (Simulated-Observed)</i>	<i>Error Statistics</i>	<i>Recommended Criteria</i>	
Error in total volume:	-0.16	10	
Error in 50% lowest flows:	2.47	10	
Error in 10% highest flows:	2.56	15	
Seasonal volume error - Summer:	1.82	20	
Seasonal volume error - Fall:	14.12	20	
Seasonal volume error - Winter:	3.38	20	
Seasonal volume error - Spring:	-10.89	20	
Error in storm volumes:	3.86	20	
Error in summer storm volumes:	7.53	20	



**Figure C.8 Observed and Modeled Flows, Calibration Period, Middle Fork Beargrass Creek above CSA**



**Figure C.9 Seasonal Flow Pattern, Calibration Period, Middle Fork Beargrass Creek above CSA**

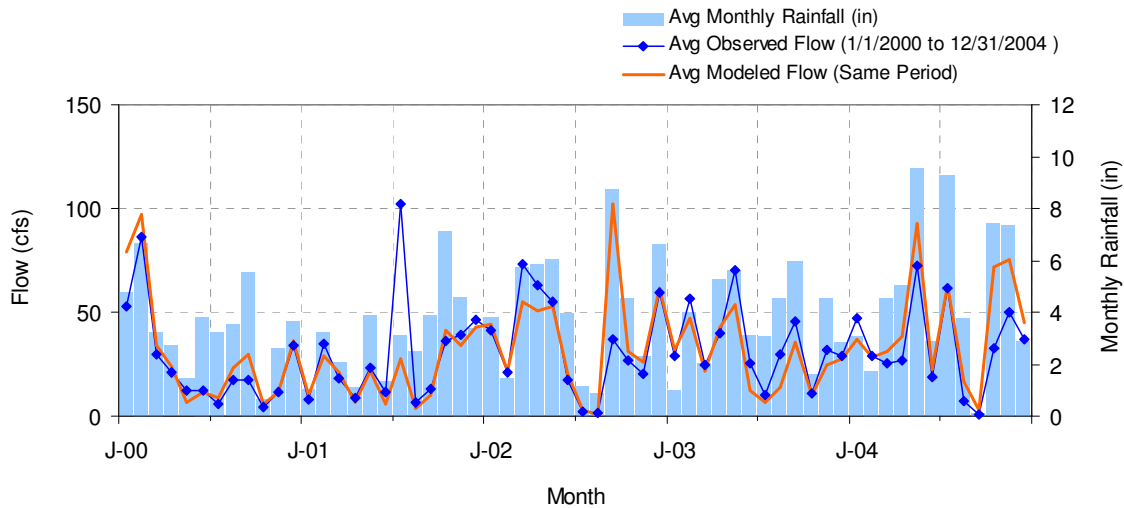


**Figure C.10 Flow Duration Curve, Calibration Period, Middle Fork Beargrass Creek above CSA**

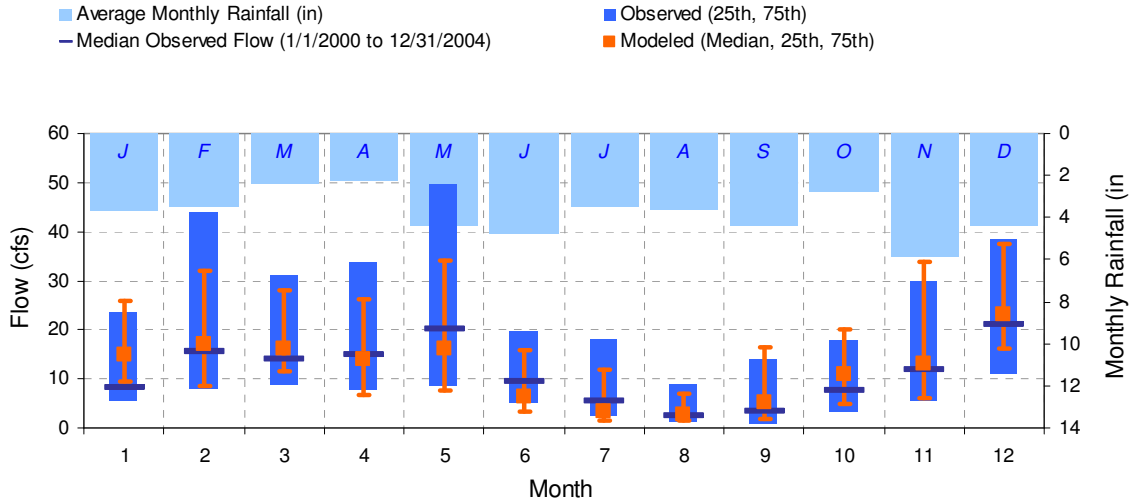


**Table C.6 Hydrologic Validation, Middle Fork Beargrass Creek above CSA**

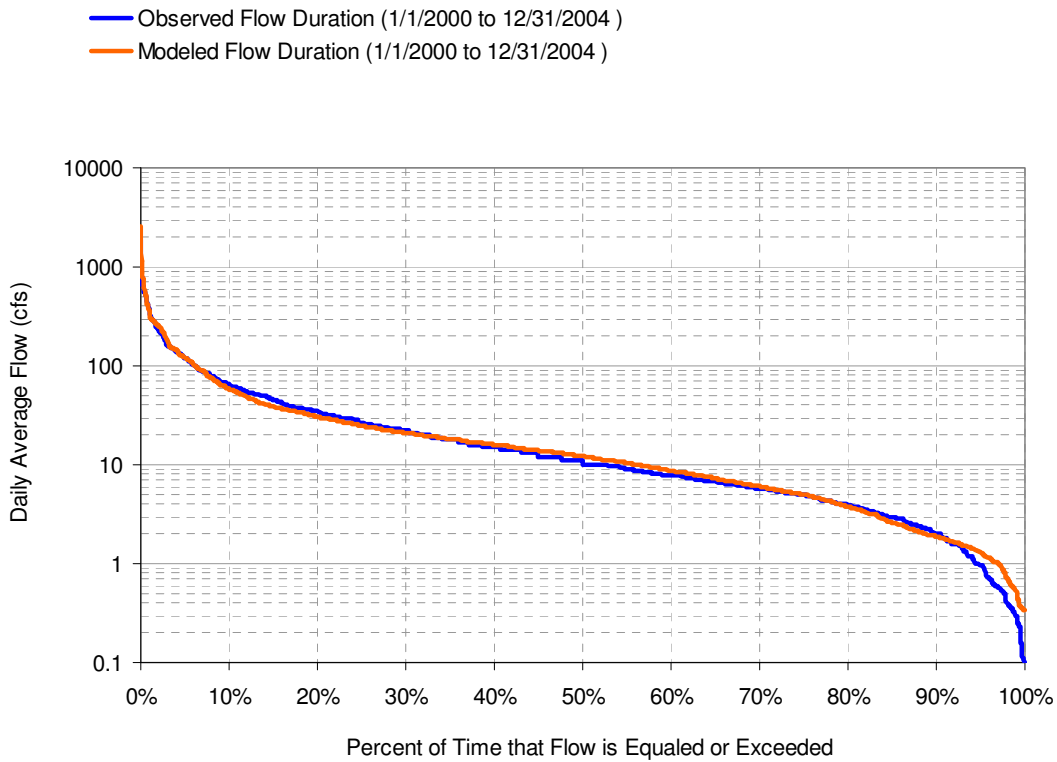
HSPF Simulated Flow		Observed Flow Gage	
<b>REACH OUTFLOW FROM SUBBASIN 740</b>		<b>USGS 03293000 M FK BEARGRASS CR AT OLD CANNONS LN AT LOUISVILLE,</b>	
5-Year Analysis Period: 1/1/2000 - 12/31/2004 Flow volumes are (inches/year) for upstream drainage area		Jefferson County, Kentucky Hydrologic Unit Code 05140101 Latitude 38°14'14", Longitude 85°39'53" NAD27 Drainage area 18.90 square miles	
Total Simulated In-stream Flow:	<b>8.93</b>	Total Observed In-stream Flow:	<b>8.65</b>
Total of simulated highest 10% flows:	<b>5.49</b>	Total of Observed highest 10% flows:	<b>5.09</b>
Total of Simulated lowest 50% flows:	<b>0.74</b>	Total of Observed Lowest 50% flows:	<b>0.68</b>
Simulated Summer Flow Volume ( months 7-9):	<b>1.60</b>	Observed Summer Flow Volume (7-9):	<b>1.66</b>
Simulated Fall Flow Volume (months 10-12):	<b>2.53</b>	Observed Fall Flow Volume (10-12):	<b>2.17</b>
Simulated Winter Flow Volume (months 1-3):	<b>2.68</b>	Observed Winter Flow Volume (1-3):	<b>2.61</b>
Simulated Spring Flow Volume (months 4-6):	<b>2.12</b>	Observed Spring Flow Volume (4-6):	<b>2.20</b>
Total Simulated Storm Volume:	<b>5.88</b>	Total Observed Storm Volume:	<b>5.51</b>
Simulated Summer Storm Volume (7-9):	<b>1.30</b>	Observed Summer Storm Volume (7-9):	<b>1.33</b>
<i>Errors (Simulated-Observed)</i>	<i>Error Statistics</i>	<i>Recommended Criteria</i>	
Error in total volume:	3.27	10	
Error in 50% lowest flows:	7.75	10	
Error in 10% highest flows:	7.78	15	
Seasonal volume error - Summer:	-3.73	20	
Seasonal volume error - Fall:	16.39	20	
Seasonal volume error - Winter:	2.51	20	
Seasonal volume error - Spring:	-3.50	20	
Error in storm volumes:	6.75	20	
Error in summer storm volumes:	-1.93	20	



**Figure C.11 Observed and Modeled Flows, Validation Period, Middle Fork Beargrass Creek above CSA**



**Figure C.12 Seasonal Flow Pattern, Validation Period, Middle Fork Beargrass Creek above CSA**

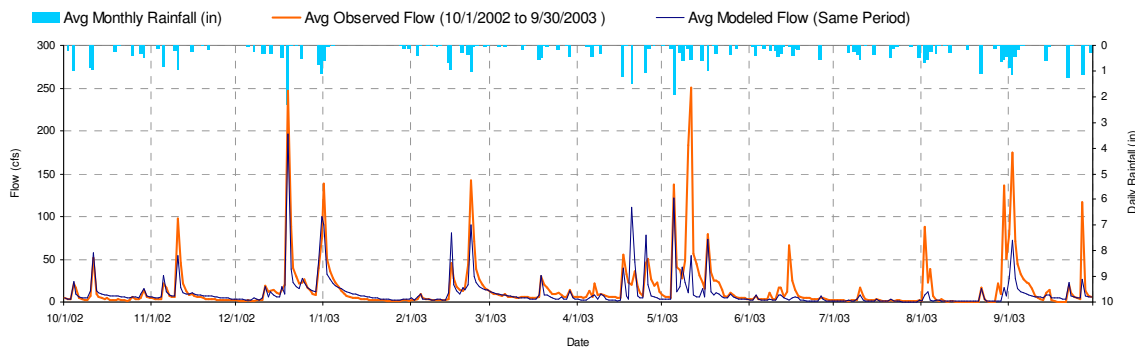


**Figure C.13 Flow Duration Curve, Validation Period, Middle Fork Beargrass Creek above CSA**

The USGS gage on Muddy Fork has been operated for only brief periods which are insufficient for full calibration. One period of record runs from October 2002 to September 2003. The agreement of the model with the observed data for this period is generally poor (Table C.7). Calls to the Kentucky office of the USGS indicated that the gage records at this location may be suspect due to frequent blockages and early issues with gage placement. Most of the flow records for 2002-2003 are flagged as estimated data. A plot of daily simulated and observed flows shows that some events are well estimated, while others appear far off (Figure C.14). Given the short period of record and the considerable uncertainty regarding the quality of gaged flow estimates, it is difficult to draw any firm conclusions from this comparison.

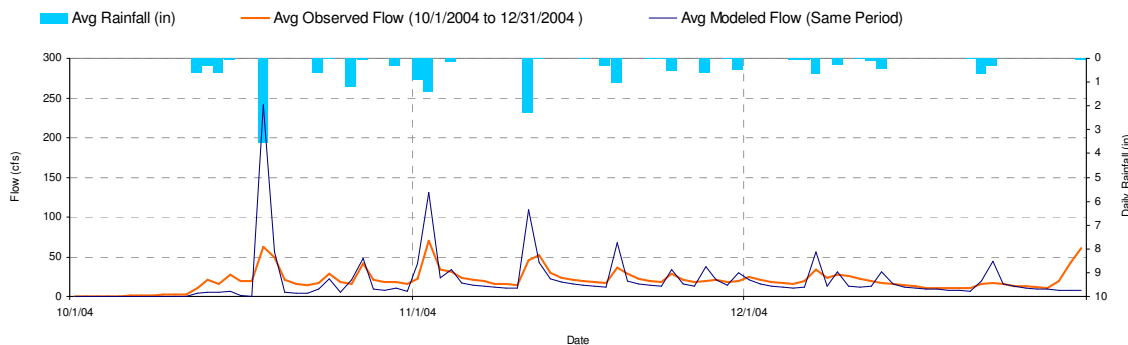
**Table C.7 Comparison of Simulated and Observed Flows, Muddy Fork, 2002-2003**

HSPF Simulated Flow		Observed Flow Gage	
<b>REACH OUTFLOW FROM SUBBASIN 920</b>		<b>USGS 03293530 MUDDY FK AT MOCKINGBIRD VALLEY RD AT LOUISVILLE,KY</b>	
1-Year Analysis Period: 10/1/2002 - 9/30/2003 Flow volumes are (inches/year) for upstream drainage area		Jefferson County, Kentucky Hydrologic Unit Code 05140101 Latitude 38°16'35", Longitude 85°41'37" NAD27 Drainage area 6.18 square miles	
Total Simulated In-stream Flow:	<b>2.86</b>	Total Observed In-stream Flow:	<b>4.32</b>
Total of simulated highest 10% flows:	<b>1.42</b>	Total of Observed highest 10% flows:	<b>2.35</b>
Total of Simulated lowest 50% flows:	<b>0.40</b>	Total of Observed Lowest 50% flows:	<b>0.40</b>
Simulated Summer Flow Volume ( months 7-9):	<b>0.37</b>	Observed Summer Flow Volume (7-9):	<b>0.93</b>
Simulated Fall Flow Volume (months 10-12):	<b>0.95</b>	Observed Fall Flow Volume (10-12):	<b>0.99</b>
Simulated Winter Flow Volume (months 1-3):	<b>0.78</b>	Observed Winter Flow Volume (1-3):	<b>0.93</b>
Simulated Spring Flow Volume (months 4-6):	<b>0.76</b>	Observed Spring Flow Volume (4-6):	<b>1.48</b>
Total Simulated Storm Volume:	<b>1.48</b>	Total Observed Storm Volume:	<b>2.43</b>
Simulated Summer Storm Volume (7-9):	<b>0.18</b>	Observed Summer Storm Volume (7-9):	<b>0.61</b>
<i>Errors (Simulated-Observed)</i>		<i>Error Statistics</i>	
<i>Errors (Simulated-Observed)</i>		<i>Recommended Criteria</i>	
Error in total volume:	-33.77	10	
Error in 50% lowest flows:	-0.14	10	
Error in 10% highest flows:	-39.61	15	
Seasonal volume error - Summer:	-60.03	20	
Seasonal volume error - Fall:	-4.56	20	
Seasonal volume error - Winter:	-15.66	20	
Seasonal volume error - Spring:	-48.30	20	
Error in storm volumes:	-39.26	20	
Error in summer storm volumes:	-69.46	20	



**Figure C.14 Muddy Fork Hydrologic Simulation, 2002-2003**

The Muddy Fork gage was reactivated in October 2004 and thus provides three additional months overlap with the model (Figure C.15).

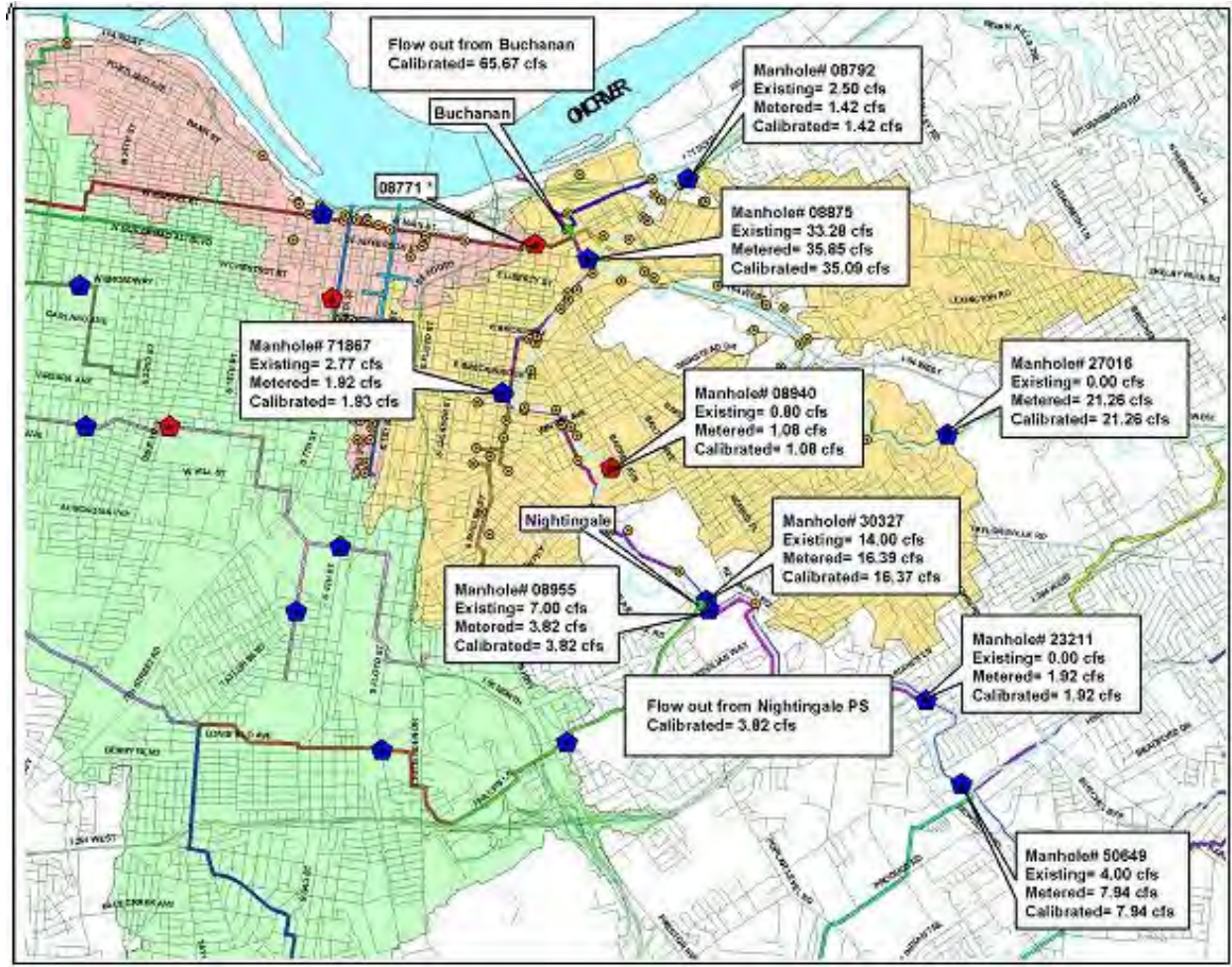


**Figure C.15 Observed and Simulated Flows, Muddy Fork at Mockingbird Valley Road, Fall 2004**

### C.3 CSS Hydrology

A calibrated SWMM model existed for the combined sewer system. Since the SWMM model had not been re-calibrated since its inception 10 years ago, additional flow monitoring was done to update the model during FY02. In conjunction with the MSD Collection System Flow Monitoring Project, additional flow monitoring sites were selected for further calibration and validation of CSOs. A total of 9 meters were installed during a monitoring period from January 29, 2002 to April 11, 2002, within the Beargrass Creek study area.

When the WQT model was upgraded, the existing dry weather flows were redistributed and adjusted throughout the system based on the 2002 flow meter data. Figure C.16 illustrates the more recent dry weather flow metered locations used for calibration purposes. A number of model simulations were executed with zero rainfall to ascertain and verify that the updated model appropriately calculated the dry weather flows at various points in the system. This was an iterative process and during this process the industrial discharge information was incorporated as part of the dry weather flow.



**Figure C.16 Dry Weather Flow Calibration Locations for SWMM Model**

For wet weather flow, an iterative re-calibration/validation procedure was performed wherein the HSPF model inputs and/or SWMM model parameters were adjusted to accurately represent the available monitoring data. Model performance was demonstrated through both graphic techniques and quantitative statistical analyses to meet statistical targets to determine the acceptability of calibration results.

The hydraulic re-calibration period for CSO was identified based on the availability of monitoring data for calibration. Based on 2002 (January through April) in-system flow data, the month of March was selected as the calibration period. The in-system flow monitoring data was utilized for both dry weather flow and wet weather flow calibration. In addition to the eight in-system meter locations, overflow data from eight CSO locations were utilized for wet weather flow calibration.

The calibration effort for the hydraulics was completed in two parts. The first focused on predicting the hydrology correctly by matching the flow in the conveyance system. Comparison of model predicted in-system flows and observed data was made for eight (8) locations listed within the conveyance system to assess whether the allocation of inflows (Runoff received from HSPF) within the system was appropriate and reasonable.

The second part of the calibration effort compared the overflow hydrographs predicted by the model to the observed overflows at the discharge outlets. These comparisons were used to identify potential locations where an inappropriate amount of runoff (either too much or too little) from HSPF was being routed to the combined sewer system. The comparisons of overflow data were used as indicators to identify potential places where sewer system hydraulics components needed to be reviewed and adjusted.

Eight in-system meter locations were selected from the flow monitoring project completed in 2002 for the CSO model recalibration effort. The location of each meter site is shown in Figure C.17 and summarized below:

- MH 08875 (Site#3)-East Main St.
- MH 08955 (Site#4)-Nightingale PS-BGIR
- MH 30327 (Site#5)-Nightingale PS-BGI
- MH 45899 (Site#6)-Seneca Park (Middle Fork Trunk Boundary)
- MH 71852-sm (Site#7)-Shelby & Caldwell
- MH 23211 (Site#8)-Trout Creek (Goldsmith Lane Trunk Boundary)
- MH 51175 (Site#9)-Mall Road (Beargrass Creek Interceptor Boundary)
- MH 08792 (Site#14)-Mellwood Ave. (NSTS Boundary)

There are 10 CSO locations where some flow monitoring data exist for the calibration period within the study area. After initial review of the data, data for two CSO locations (CSO110 and CSO140) were eliminated from use in calibration. For CSO110, monitored data showed no correlation between precipitation and overflow, suggesting that the occurrence of CSOs may be driven primarily by mechanical problems, rather than flow. Records for CSO140 were incomplete and did not have velocity and level data to verify the flow information. The eight remaining CSO meter sites are also shown in Figure C.17 and summarized below:

- CSO108 – Newburg Road near Trevilian Way (South Fork)
- CSO117 – Dry Run Sewer, Logan Street at Caldwell Street (South Fork)
- CSO125 – Grinstead Drive Sewer, near Grinstead Drive and I-64 (Middle Fork)
- CSO127 – Lexington Road opposite Etley Avenue (Middle Fork)
- CSO147 – Swan Street just north of Beargrass Creek (South Fork)
- CSO151 – Castlewood Diversion and Siphon near south end of Castlewood Dell (South Fork)
- CSO206 – Cherokee Park at Spring Drive (Middle Fork)
- CSO209 – Alta Avenue Sewer (Middle Fork)



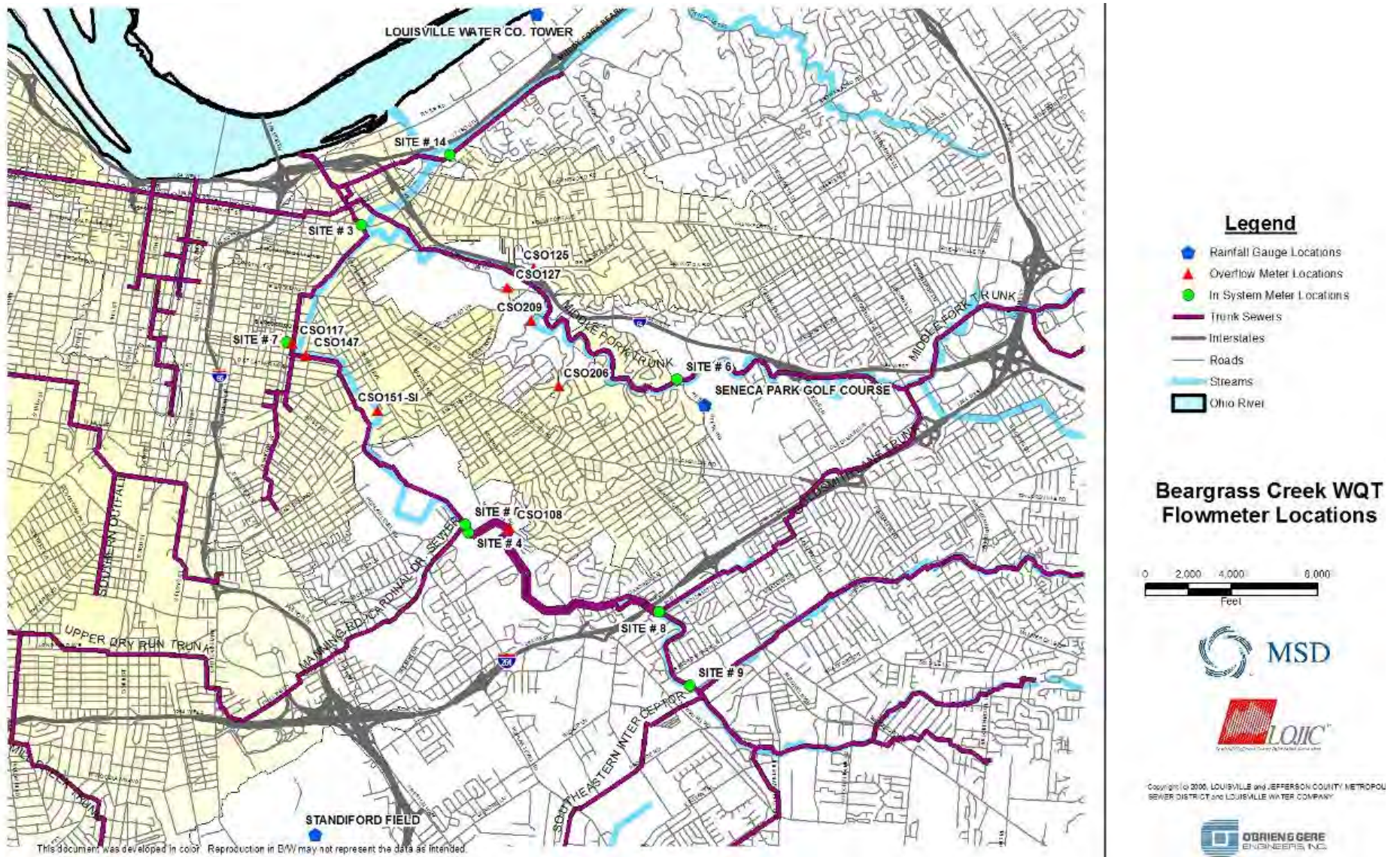


Figure C.17 2002 Flowmeter Locations for SWMM Calibration

Initial applications to 2002 revealed several discrepancies in the specification of hydraulic structures. In particular, the following changes were made to improve model performance:

1. CSO108 – The overflow elevation in the model was adjusted to the correct CSO elevation listed in the CSO Inventory and the roughness value was revised from 0.010 to 0.014.
2. CSO117 /149 – The overflow volume from CSO117 was adjusted by improving CSO149. The CSO149 overflow elevation was adjusted to reflect the overflow elevation listed in the CSO inventory. This adjustment accounted for more overflow discharge to CSO149 and reduced the overflow volume to CSO117.
3. CSO127 – The Willow Lake configuration was added to the model network.
4. CSO 110 - The model simulated this regulated CSO as discharging every day during dry weather, except from about 6 AM to 9:30 AM, at about 0.4 cfs. This was determined to be incorrect and corrected (implemented in the bridge routine).

Initial model re-calibration results were presented in a memorandum dated August 7, 2006. These results generally did not meet the criteria specified in the QAPP of predicting individual CSO volumes within 20 percent. Therefore, an intensive effort was pursued to diagnose and potentially improve model prediction performance. The following possible sources of inaccuracy in the hydraulic simulation were investigated:

- Precipitation- Limited information on precipitation characteristics during calibration always presents a challenge for any modeler. Precipitation is a critical input to the model, especially in a CSO area where overflow/runoff may be very sensitive and localized. As part of the investigative work, the modeling team reviewed the available precipitation data including a radar animation of the March 29, 2002 storm event. The modeling team recognized that significant differences existed between the site-specific rain gauge data and the spatial distribution represented in the radar rainfall data. However, because of the general variability of rainfall distributions and patterns and the uncertainty of stream gauging, a decision was made not to revise the precipitation data.
- Inflow/Infiltration –The presence of rainfall driven Inflow & Infiltration (I/I) in the sewer system was recognized through review of flow monitoring records as well as the recent draft sewer assessment reports for both the South Fork and Middle Fork Beargrass Creek area. This was an iterative process between the HSPF and SWMM models to determine the most reasonable approach to represent I/I. Flow adjustments were incorporated into the HSPF Runoff model. The resulting changes to the runoff inflow to the individual SWMM nodes were then incorporated into the CSS model by applying the new runoff interface file.
- Boundary Conditions- The in-system model prediction accuracy improved with the direct application of the flow metered data as boundary condition hydrographs; however, there were essentially no changes to the CSO volume predictions. The modelers recognized that it might be possible to improve the upstream boundary conditions to better match the trailing limbs of the March 19 and 25, 2002 event hydrographs. However, without more specific data to better define I/I, it was not possible to define the specific variables in the



model that would require changes to calculate the I/I. The project team decided to keep the current boundary conditions although acknowledging that some improvement in model predictions was likely possible, if more specific I/I data were available. This could be an issue to pursue in future programs.

- CSO Structures- There are many hydraulic structures associated with CSOs within the study area, such as siphons, flow regulators, dams, and pump stations. Very little information is available related to the operating conditions of these structures. Thus, the operation of the CSO regulators is definitely an area of uncertainty. There are eight (8) regulators in the study area and only 4 are in operation according to the MSD staff. The modeler assumed that the operating conditions were the same as the original designs and began to restrict flow to the interceptor when the water level at the downstream interceptor reached 80% of full depth. This assumption was reasonably verified by comparing overflow hydrographs to the monitored data from two of the four CSO locations with operating regulators. The four CSOs with operating regulators are CSO109, 110, 125, and 131. The model configuration was updated to include a rule curve that restricted flow from the regulator to the interceptor at certain elevations.

The final results of CSO hydrologic calibration were within a 10% difference of the observed value for both total and wet-weather flows for the in-system monitors -- which meets the calibration target of 20%. For overflow volume, at six of the eight CSO monitoring locations the model predicted CSO volumes within 20% of observed volumes individually, with a total difference for all eight sites of -15%.

Tables C.8 through C.12 show the results of the initial (July 2006) and final hydraulic calibration simulations. The first three tables compare CSO and in-system flow volumes. Much of the flow in the system goes through two pump stations en route to the treatment plant, and the model can be compared to flows estimated from pump operation records to provide another check on the total volume simulation. Figures C.18 through C.28 also show the results of the final hydraulic calibration simulation in graphical format. Observations to note about the comparison hydrographs are:

- The CSS model is generally predicting the start and end times reasonably (within an hour or so of the observed starts and ends).
- The CSS model does not necessarily predict the trailing limb of the hydrograph for the reasons explained previously under boundary condition.

**Table C.8 CSO Overflow Volume Summary, March 2002**

<b>CSO</b>	<b>Drainage Area</b>	<b>Monitored Volume (cf)</b>	<b>Modeled Volume (cf)</b>	<b>Difference (cf)</b>	<b>Percent Difference</b>
108	485.2	937,880	961,808	23,928	3%
117	74.2	2,076,115	2,327,090	250,976	12%
125	391.0	3,679,669	3,030,527	-649,142	-18%
127	192.3	2,252,462	1,348,783	-903,678	-40%
147	CSO closure by 2007	18,270	21,229	2,960	16%
151	219.7	3,339,552	2,346,106	-1,053,447	-31%
206	Partial Sewer Separation	4,225,587	4,081,021	-144,565	-3%
209	CSO closed in 2005	92,017	100,494	8,477	9%
Total Overflow Volume		16,681,551	14,217,059	-2,464,492	<b>-15%</b>

**Table C.9 CSS In-System Total Flow Volume Summary, March 2002**

<b>MH</b>	<b>Interceptor</b>	<b>Monitored Volume (cf)</b>	<b>Modeled Volume (cf)</b>	<b>Difference (cf)</b>	<b>Percent Difference</b>
08792	NSTS Boundary	4,818,459	4,820,368	1,909	0%
08875	BGI	121,601,649	111,637,148	-9,964,500	-8%
08955	BGIR	36,363,076	28,468,238	-7,894,837	-22%
23211	Goldsmith Lane – BGIR Boundary	17,174,858	17,750,351	575,493	3%
30327	BGI	42,640,845	45,434,144	2,793,299	7%
45899	MF Boundary	71,786,763	71,639,314	-147,449	0%
51175	BGI Boundary	26,829,864	26,781,934	-47,930	0%
71852-sm	Near SBR	11,112,108	13,613,594	2,501,486	23%
Total		332,327,622	320,145,091	-12,182,531	<b>-4%</b>

**Table C.10 CSS In-System Wet Weather Flow Volume Summary Table, March 2002**

<b>MH</b>	<b>Interceptor</b>	<b>Monitored Volume (cf)</b>	<b>Modeled Volume (cf)</b>	<b>Difference (cf)</b>	<b>Percent Difference</b>
08792	NSTS Boundary	1,260,507	1,214,139	-46,368	-4%
08875	BGI	31,775,889	23,496,987	-8,278,902	-26%
08955	BGIR	26,942,020	18,892,576	-8,049,443	-30%
23211	Goldsmith Lane – BGIR Boundary	12,489,386	12,945,033	455,647	4%
30327	BGI	1,574,061	4,661,468	3,087,407	196%
45899	MF Boundary	18,968,715	18,430,287	-538,428	-3%
51175	BGI Boundary	6,985,512	6,986,128	616	0%
71852-sm	Near SBR	6,326,412	8,780,292	2,453,880	39%
Total		106,322,502	95,406,909	-10,915,592	<b>-10%</b>

**Table C.11 Total Flow Volume at Two Major Pump Stations, March 2002**

<b>Location</b>	<b>Estimated from Pump Operation Record (cf)</b>	<b>Initial Calibration (July 2006) (cf)</b>	<b>Final Model (cf)</b>
Buchanan	220,990,914	200,002,620	223,030,717
Nightingale	43,200,201	37,270,950	32,635,262
<b>Total Volume</b>	264,191,114	237,273,570	255,635,262
<b>Volume Difference</b>			-8,525,135
<b>Percent Difference</b>			-3 %

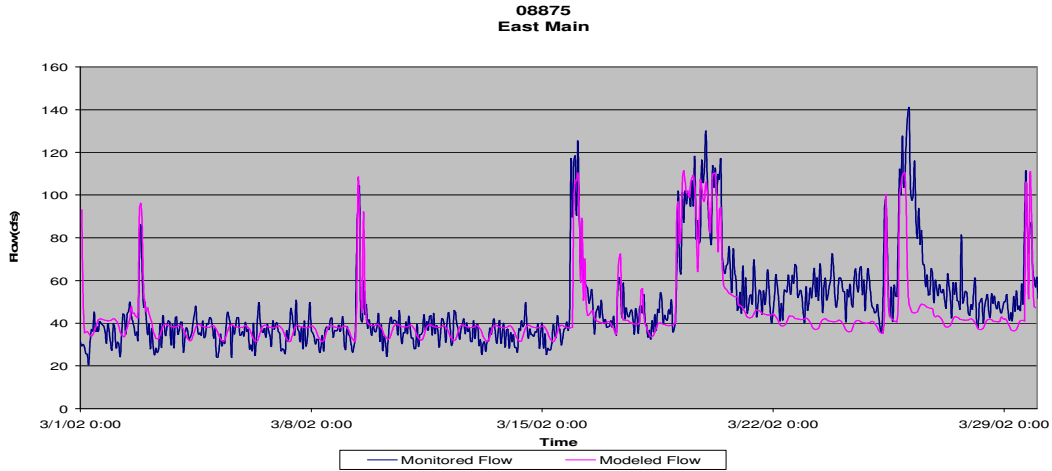
**Table C.12 Wet Weather Flow Volume at Two Major Pump Stations, March 2002**

<b>Location</b>	<b>Estimated from Pump Operation Record (cf)</b>	<b>Initial Calibration (July 2006) (cf)</b>	<b>Final Model (cf)</b>
Buchanan	58,126,914	37,138,620	60,166,717
Nightingale	30,672,201	27,248,550	22,612,862
<b>Total Volume</b>	88,799,114	64,387,170	82,779,579
<b>Volume Difference</b>			-6,019,535
<b>Percent Difference</b>			-3 %

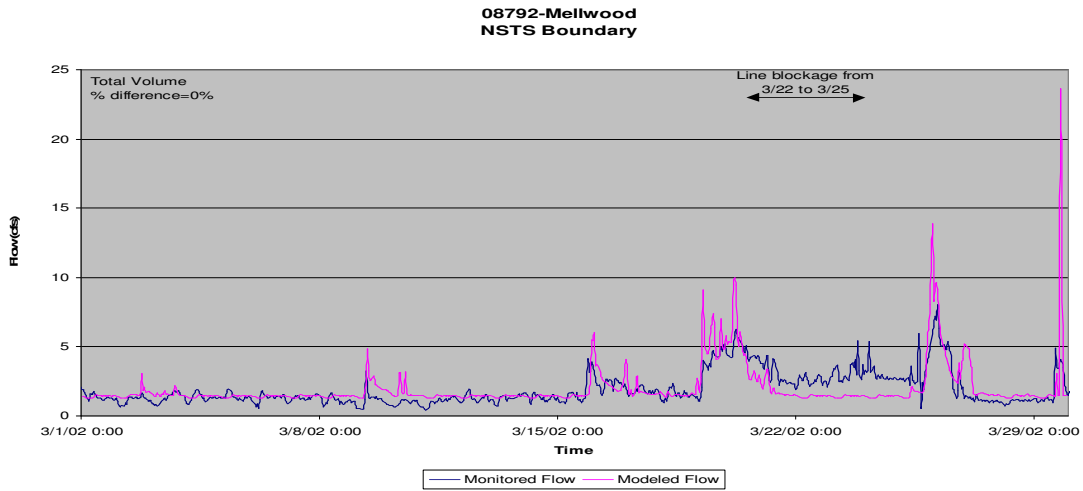
Notes: Wet Weather Flows for both pump stations were calculated by subtracting total dry weather flow volume during calibration period.

\*DWF for Nightingale PS estimated using average daily flow of 4cfs for 29 days.

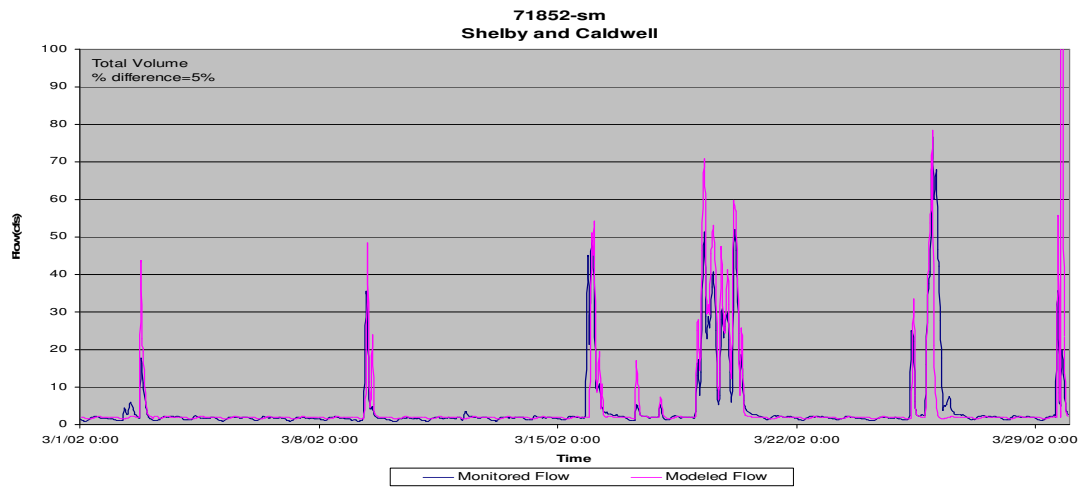
\*DWF for Buchanan PS (Robert Starkey PS) estimated using average daily flow of 65 cfs for 29 days



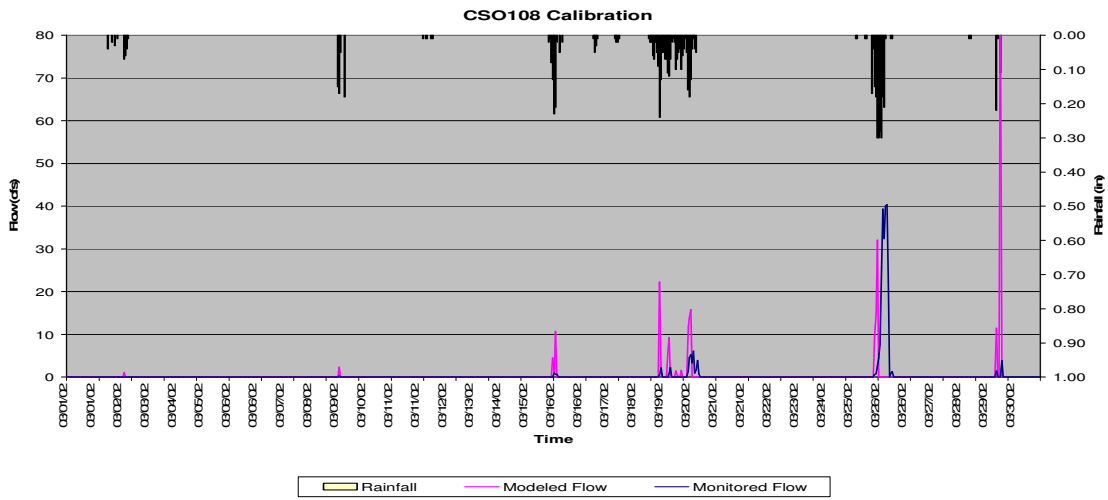
**Figure C.18 Individual Calibration Graphs for In-system Meter #3**



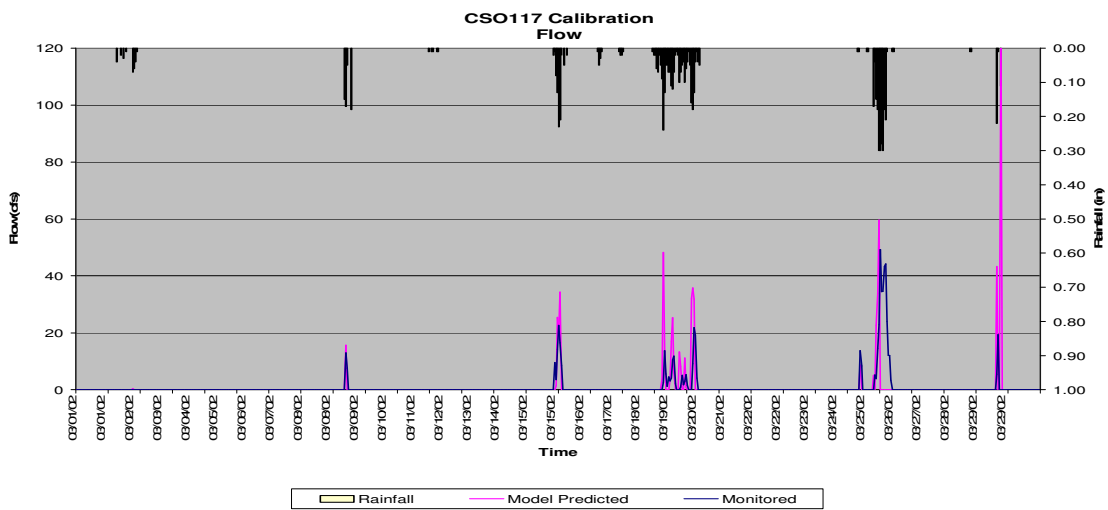
**Figure C.19 Individual Calibration Graphs for In-system Meter #14**



**Figure C.20 Individual Calibration Graphs for In-system Meter #7**



**Figure C.21 Individual Calibration Graphs for CSO 108**



**Figure C.22 Individual Calibration Graphs for CSO 117**

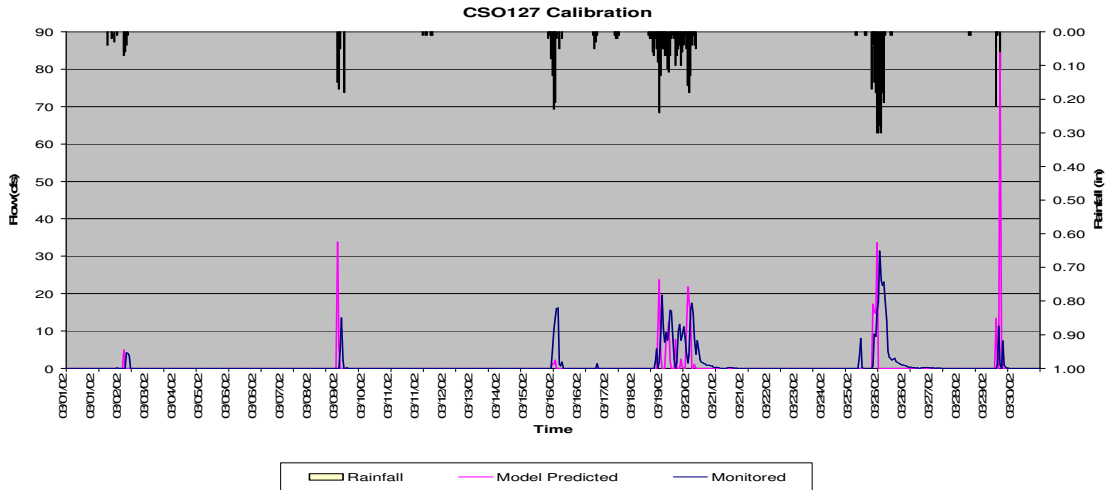


Figure C.23 Individual Calibration Graphs for CSO 127

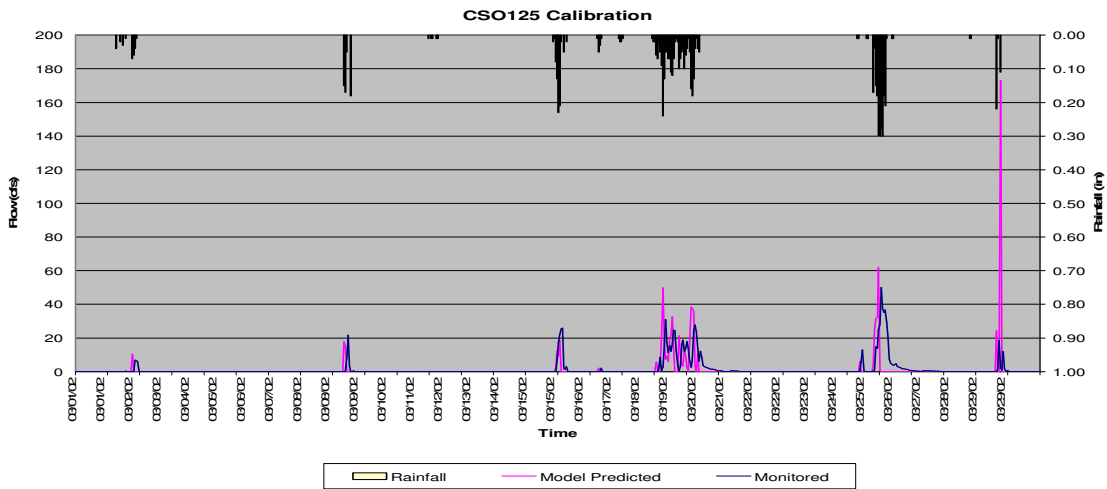


Figure C.24 Individual Calibration Graphs for CSO 125

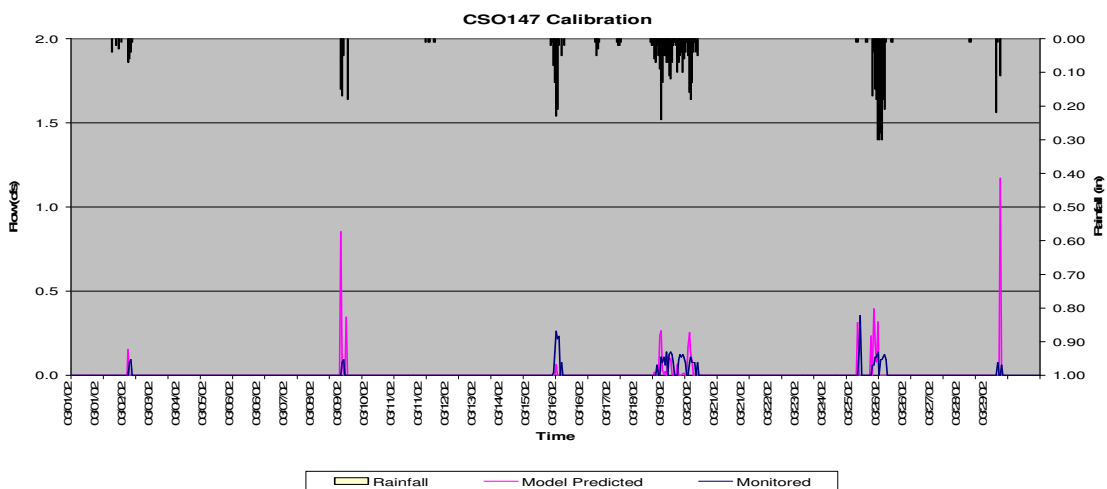


Figure C.25 Individual Calibration Graphs for CSO 147

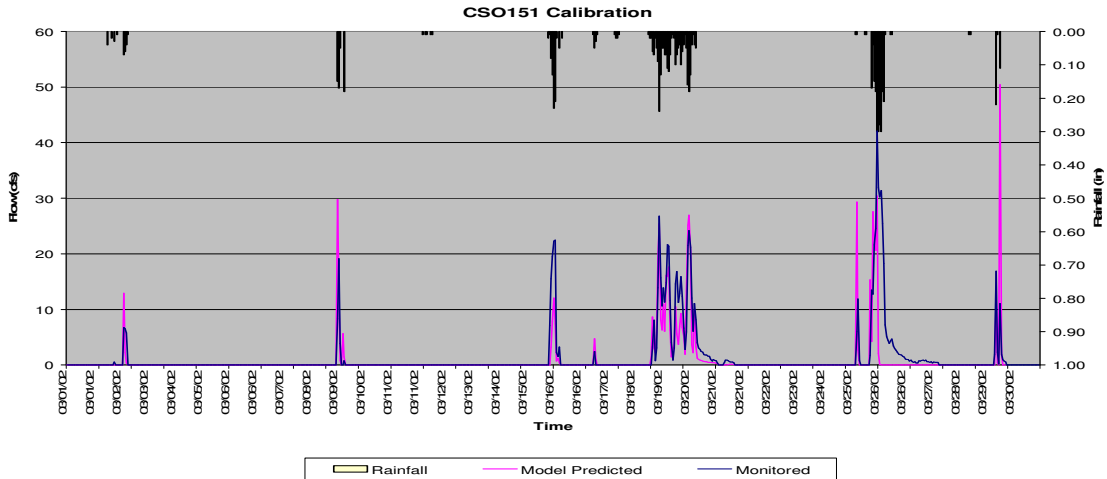


Figure C.26 Individual Calibration Graphs for CSO 151

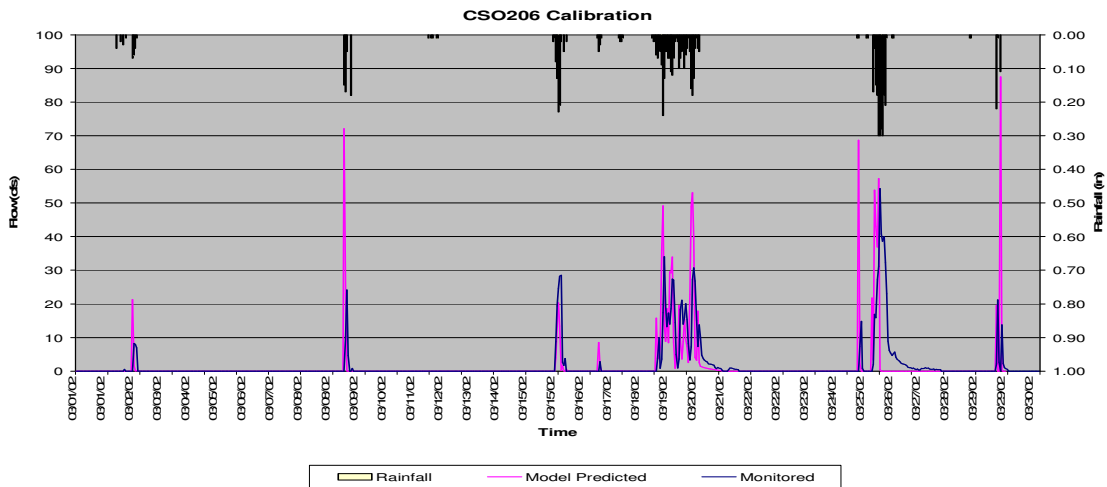


Figure C.27 Individual Calibration Graphs for CSO 206

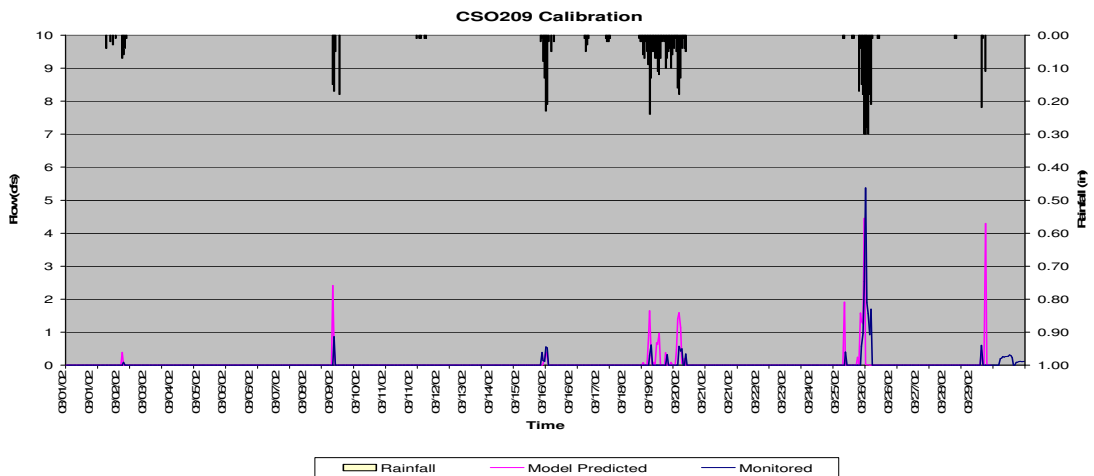


Figure C.28 Individual Calibration Graphs for CSO 209

#### C.4 Hydrology downstream of CSA

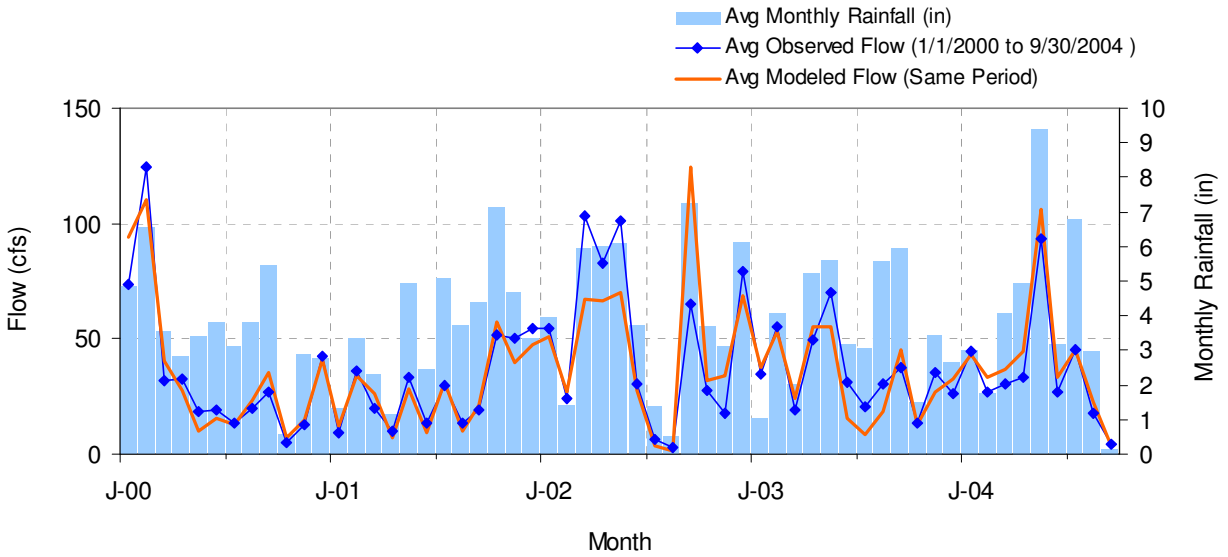
Flow is gaged on the South Fork of Beargrass Creek at Winter Ave. (USGS 03292550) within the CSA and downstream of many CSO outfalls. This station is used to evaluate hydrology of the linked HSPF and CSO models. Flow gaging at 03292550 did not commence until September 1998, and the SWMM model runs to simulate contribution from CSOs do not start until the beginning of 2000. Results for this gage were used informally in the calibration process, with good results; however, a formal statistical analysis is not provided due to the short time period and lack of CSO simulation. Instead, detailed statistics for this station are presented as a validation test of the hydrologic simulation for the South Fork. Results are shown in Table C.13 and Figures C.29 through C.31.

Since commencement of the downstream gaging, about 20% of the reported daily flows at Winter Ave. are less than those reported upstream at Trevilian Way, mostly during low flow. This could reflect losses to ground water, inaccuracies in gaging, or simply retention of water in the stream network. No reach losses are specified in the model. The model does predict that about 20% of days will have less flow at Winter Ave. than upstream, but does not reproduce the observed behavior during persistent low flow periods. Further investigation and linkage to a groundwater model thus might improve the simulation of surface hydrology.

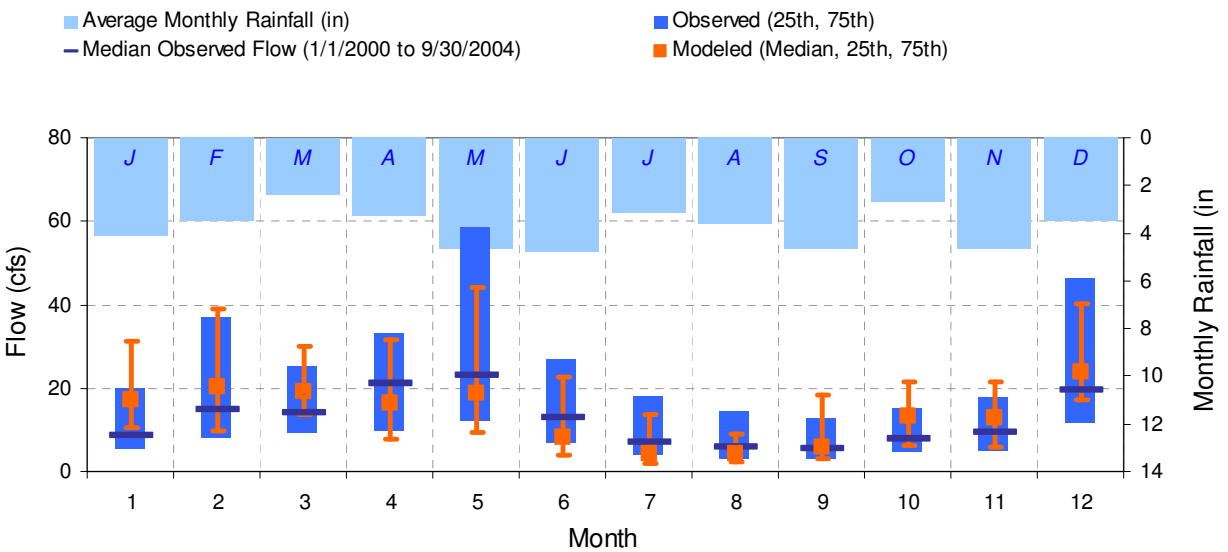
**Table C.13 Hydrologic Validation, South Fork Beargrass Creek within CSA**

HSPF Simulated Flow		Observed Flow Gage	
<b>REACH OUTFLOW FROM SUBBASIN 500</b>		<b>USGS 03292550 S FK BEARGRASS CR AT WINTER AVE AT LOUISVILLE, KY</b>	
4.75-Year Analysis Period: 1/1/2000 - 9/30/2004 Flow volumes are (inches/year) for upstream drainage area		Jefferson County, Kentucky Hydrologic Unit Code 05140101 Latitude 38°14'04", Longitude 85°43'50" NAD27 Drainage area 49.20 square miles	
Total Simulated In-stream Flow:	<b>10.07</b>	Total Observed In-stream Flow:	<b>10.19</b>
Total of simulated highest 10% flows:	<b>6.11</b>	Total of Observed highest 10% flows:	<b>6.28</b>
Total of Simulated lowest 50% flows:	<b>0.86</b>	Total of Observed Lowest 50% flows:	<b>0.85</b>
Simulated Summer Flow Volume ( months 7-9):	<b>1.97</b>	Observed Summer Flow Volume (7-9):	<b>1.72</b>
Simulated Fall Flow Volume (months 10-12):	<b>2.03</b>	Observed Fall Flow Volume (10-12):	<b>2.04</b>
Simulated Winter Flow Volume (months 1-3):	<b>3.30</b>	Observed Winter Flow Volume (1-3):	<b>3.29</b>
Simulated Spring Flow Volume (months 4-6):	<b>2.78</b>	Observed Spring Flow Volume (4-6):	<b>3.14</b>
Total Simulated Storm Volume:	<b>6.63</b>	Total Observed Storm Volume:	<b>6.87</b>
Simulated Summer Storm Volume (7-9):	<b>1.57</b>	Observed Summer Storm Volume (7-9):	<b>1.32</b>
<i>Errors (Simulated-Observed)</i>	<i>Error Statistics</i>	<i>Recommended Criteria</i>	
Error in total volume:	-1.15	10	
Error in 50% lowest flows:	0.74	10	
Error in 10% highest flows:	-2.75	15	
Seasonal volume error - Summer:	14.29	20	
Seasonal volume error - Fall:	-0.43	20	
Seasonal volume error - Winter:	0.17	20	
Seasonal volume error - Spring:	-11.48	20	
Error in storm volumes:	-3.53	20	
Error in summer storm volumes:	18.82	20	

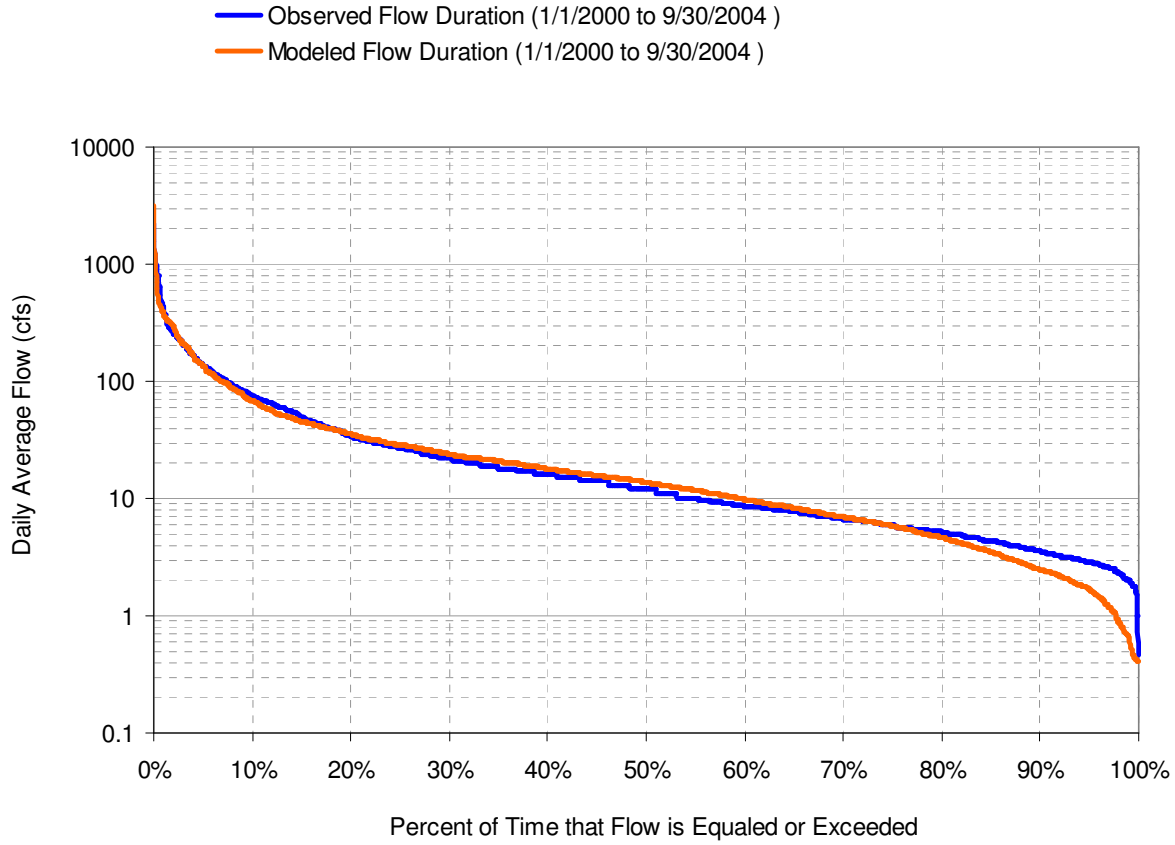




**Figure C.29 Observed and Modeled Flows, South Fork Beargrass Creek within the CSA**

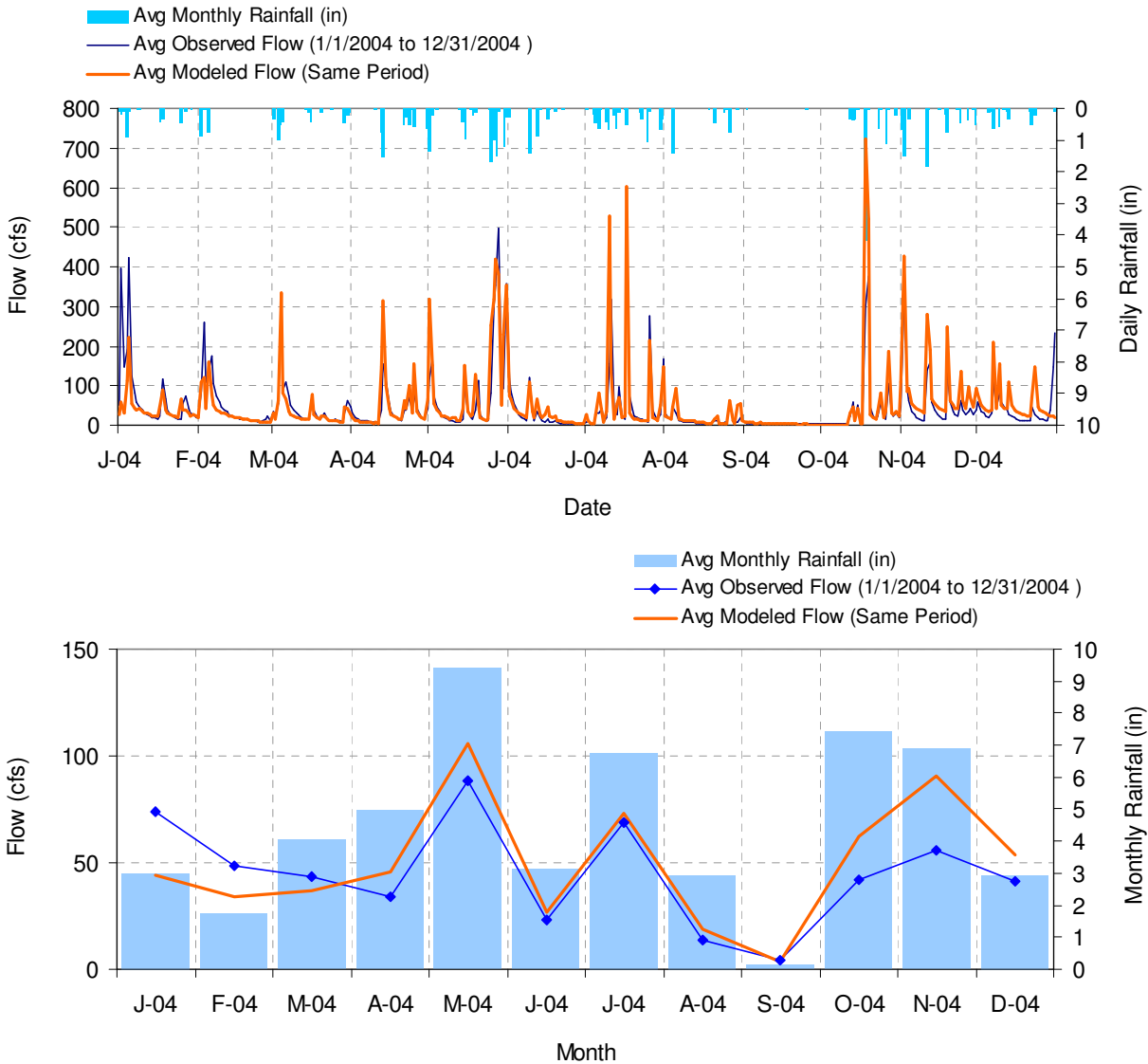


**Figure C.30 Seasonal Flow Pattern, South Fork Beargrass Creek within the CSA**



**Figure C.31 Flow Duration Curve, South Fork Beargrass Creek within the CSA (03292550)**

The USGS gage on Middle Fork at Lexington Rd. (03293500) has only been active since 7/1/2003 (except for a brief earlier period in 1996), and much of the data are flagged as estimated. Because there is only a brief period of overlap between this gage record and the model, formal statistical analyses are not provided. Figure C.32 compares the observed and modeled flows for 2004. In general, the model reproduces observed trends. The largest discrepancies are in January and November-December, when most of the observed data are flagged as estimated.



**Figure C.32 Observed and Modeled Flows, Middle Fork Beargrass Creek within the CSA**

**C.5 Regression and Bias Analyses**

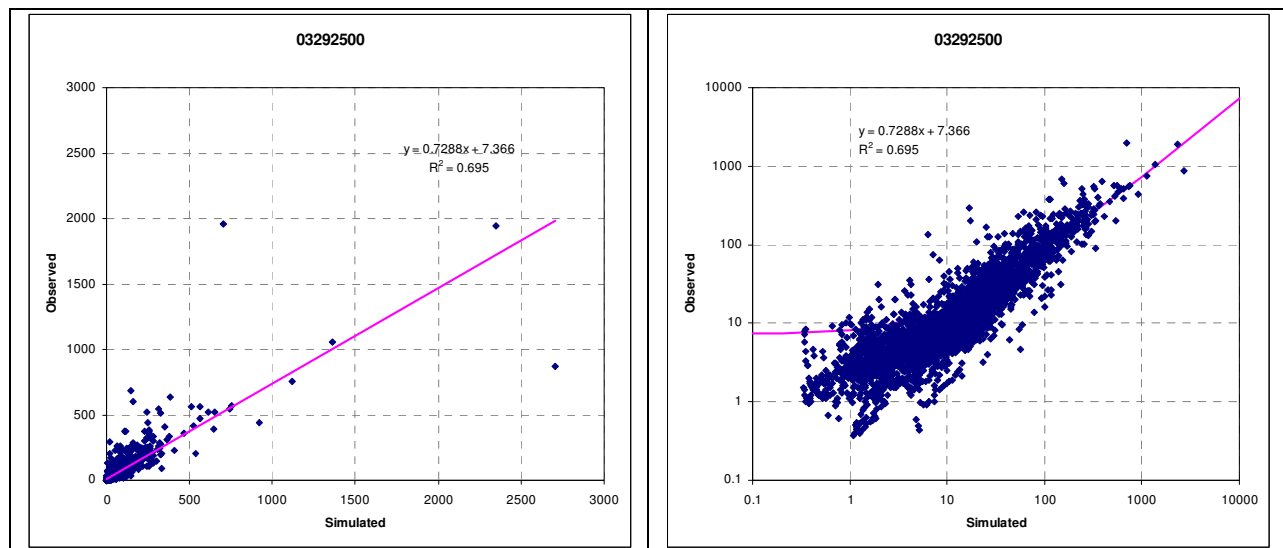
The modeling QAPP specifies several additional tests of the hydrologic simulation. First, the QAPP calls for regression of predicted on observed daily flow values. This is specified as a qualitative test, but the QAPP states that, “in general, a linear regression of predicted on observed values should yield a high  $R^2$ , an intercept that approaches zero, and a slope that approaches 1.” A perfect fit between model and data should indeed yield a slope of one and an intercept of zero. A problem for this type of analysis is that the residuals in the regression typically exhibit autocorrelation due to persistence in the effects of rainfall errors. For example, if the measured rainfall at a gage on a given day is biased low relative to the integrated rainfall across the drainage area, then the simulated flow on that day will be biased low, and flow on subsequent days will also tend to be biased low because the amount of water entering subsurface

stores will also be underestimated. In a comparison of daily observed and simulated flows, the positive autocorrelation of residuals tends to result in a regression toward the mean, in which the slope will be less than 1 and the intercept greater than zero. Over longer time scales, these errors will tend to balance out (unless there is a consistent bias in the meteorological time series), which is why analyses of model fit traditionally rely on summary statistics over long periods of time.

Regression results for the three gages with long periods of record are displayed in Table C.14. The behavior of the linear regression model for gage 03292500 (South Fork Beargrass Creek at Trevilian Way) is explored further in Figure C.33. The plot on an arithmetic scale (left panel) shows that regression is strongly influenced by a small set of outliers. The plot on a logarithmic scale (right panel) shows that the relationship is approximately linear, although the regression line is biased to a non-zero intercept by the leverage of the outliers.

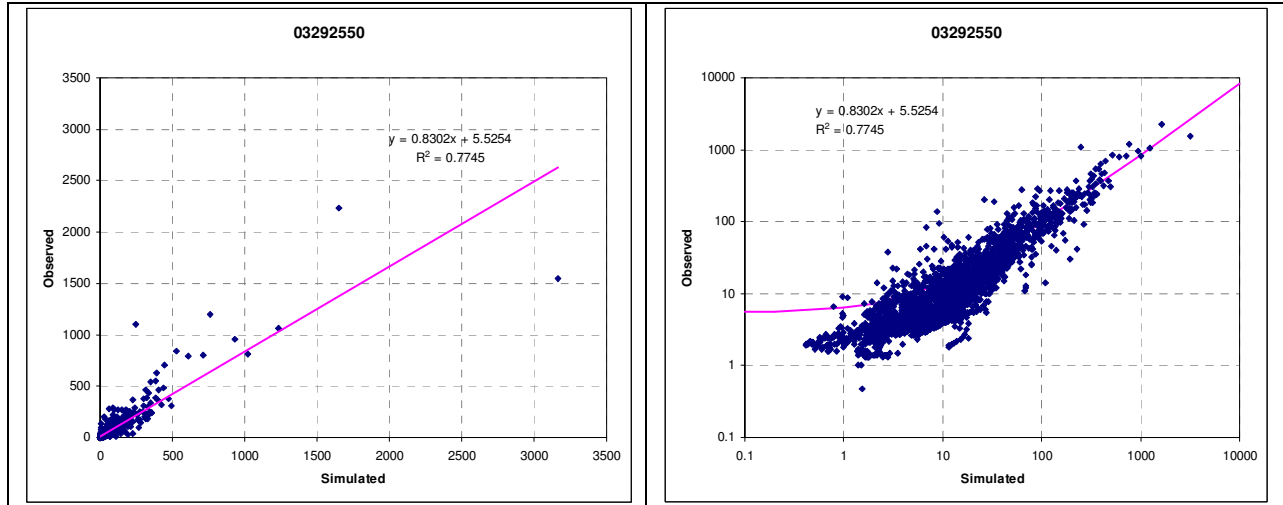
**Table C.14 Regression of Observed on Simulated Daily Flows**

Gage	Intercept (95% Confidence Limits)	Slope (95% Confidence Limits)	R <sup>2</sup>	Root Mean Squared Error
03292500, 1995-2004	7.4 (5.9 – 8.8)	0.73 (0.71 – 0.74)	69.5%	41.8
03292550, 1998-2004	5.5 (3.5 – 7.6)	0.83 (0.81 – 0.85)	77.5%	46.3
03293000, 1995-2004	8.9 (7.3 – 10.5)	0.68 (0.67 – 0.70)	62.2%	47.4

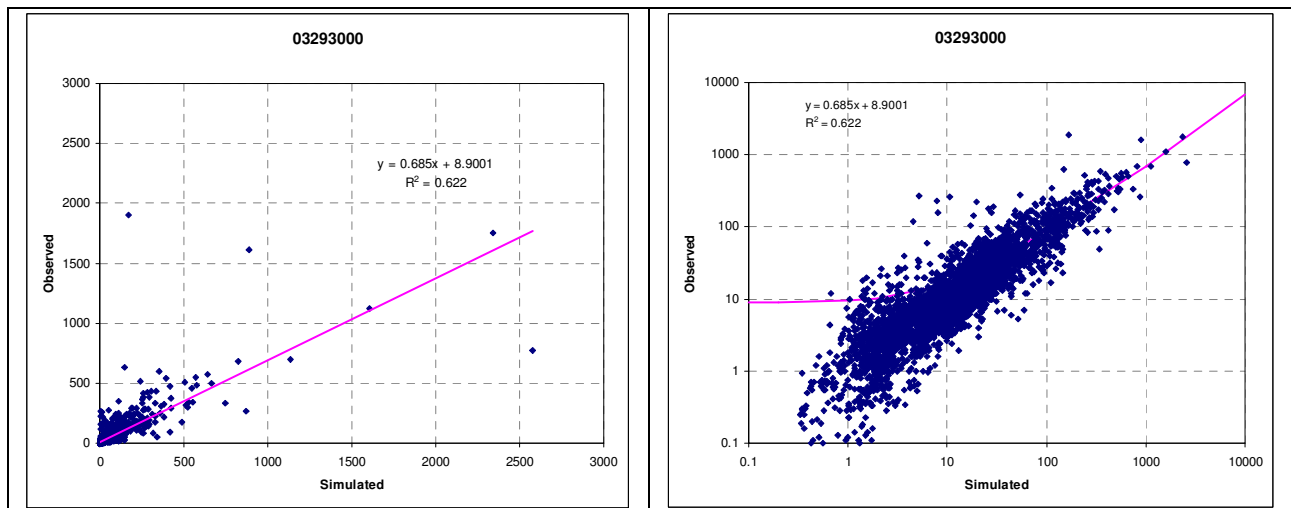


**Figure C.33 Regression of Observed on Simulated Daily Flows at Gage 03292500**

Root mean squared errors, a measure of the spread about the regression line, are similar at all three sites. Regression results for gages 03292550 and 03293000 are shown in Figures C.34 and C.35.



**Figure C.34. Regression of Observed on Simulated Daily Flows at Gage 03292550**

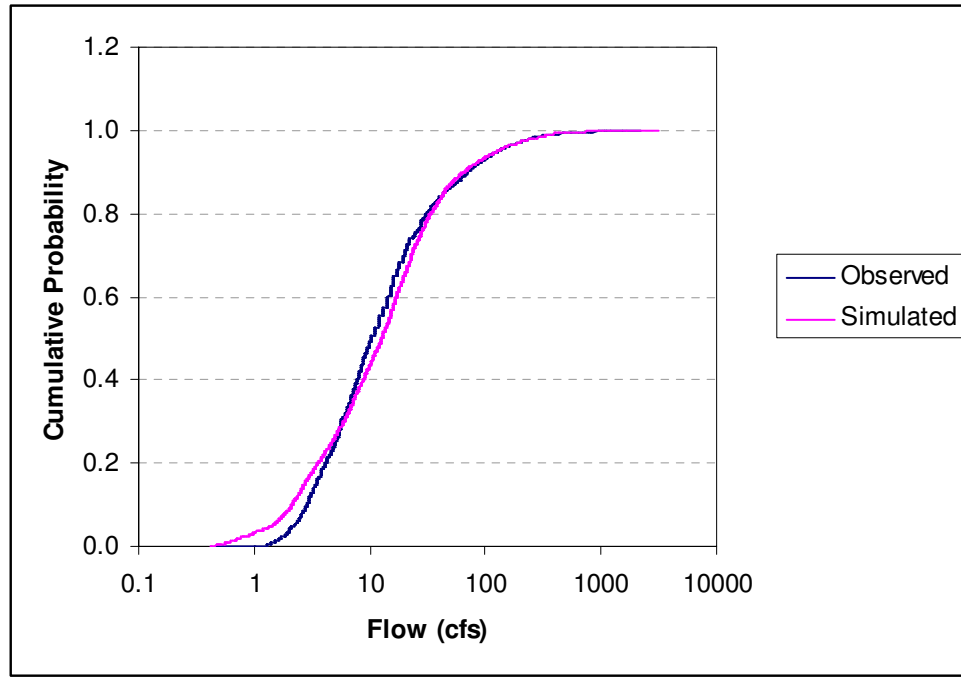


**Figure C.35 Regression of Observed on Simulated Daily Flows at Gage 03293000**

The QAPP also recommends comparing the observed and simulated flow distributions using the two-sample Kolmogorov-Smirnov test. This non-parametric test generates a sample statistic *D* that represents the maximum distance between the cumulative probability distributions of two samples. It then tests the value of *D* against the null hypothesis that the two distributions are identical.

This test is not particularly appropriate for the comparison of two continuous flow series for the simple reason that, with large sample sizes, the difference between the cumulative distributions may be statistically significant while the actual magnitude of the difference may be quite small. This is exactly what occurs in this case. The calculated magnitude of *D* is small, ranging from 0.0566 at 03293000 to 0.0859 at 03292500. The probability value associated with these values of *D* are all less than 0.0001, suggesting that the null hypothesis should be rejected. For station 03292550, the cumulative distributions (which provide essentially the same information as was shown above in Figure C.31) are shown in Figure C.36. *D* is equal to the maximum difference

between the two curves, or 0.0716, which occurs at a flow of about 2.6 cfs and has a probability value of 0.000024. The two distributions are thus statistically different from one another, but the magnitude of the difference is small and within the generally accepted range for HSPF model applications



**Figure C.36 Cumulative Distribution Functions for Observed and Modeled Daily Flows at Gage 03292550**

A check against seasonal bias in the model was undertaken through examination of residuals. The following pages contain three figures each for USGS gages 03292500, 03292550, and 032923000 (Figures C.37-C.45). The first plot contains the monthly residuals, presented as HSPF model results less observed flows as monthly averages in cfs. The second plot contains the unitless normalized residuals (residual divided by the product of precipitation and area) intended to correct for variability in rainfall. Both the first and second plots highlight the March 2002 result in red. The third plot compares the cumulative observed and simulated flow predictions over time.

The residuals plots show little evidence of consistent bias. Most residuals are close to zero, and, where the average deviates from zero this is usually attributable to a single month (such as September 2002), in which model predictions are poor. In this month there were several rainfall events evident at the gage that do not show up in the precipitation record (see Figure C.46).

Cumulative runoff plots show no significant bias, which would be represented by a divergence between the cumulant lines, at the gages above the combined sewer service area. The model results for March 2002 do show an under-prediction at all three gages. This under-prediction is due almost entirely to the single rainfall event of March 25-26, 2002. The mean bias for March is near zero.

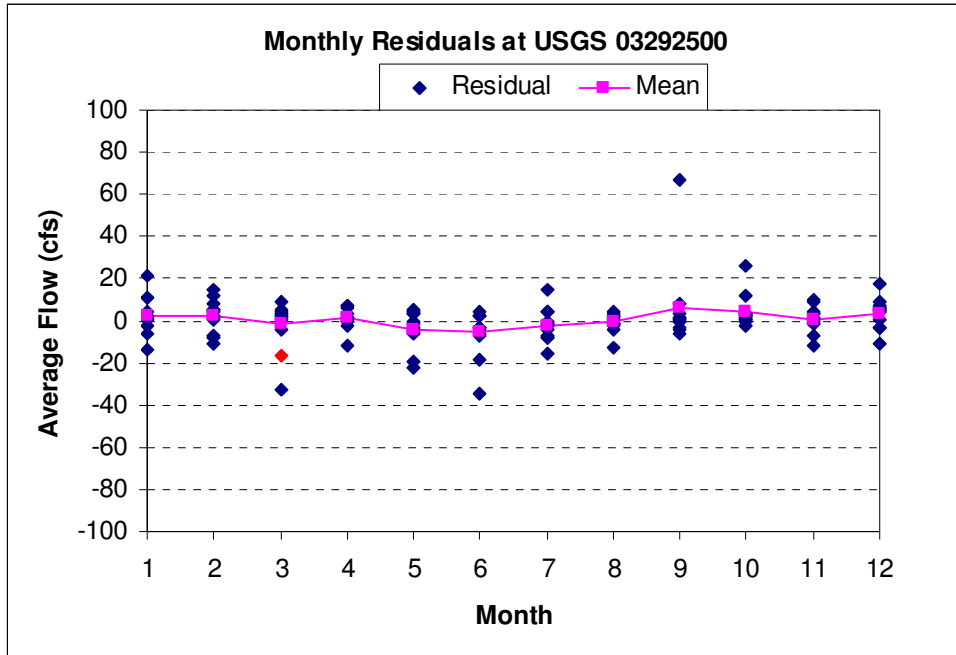


Figure C.37 Flow Residuals by Month at USGS 03292500

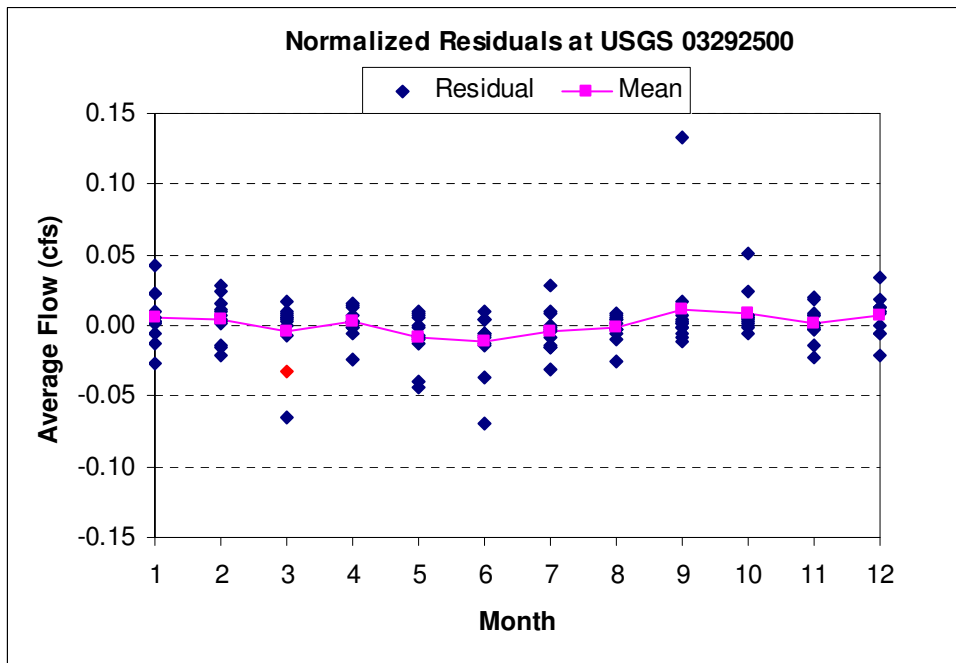
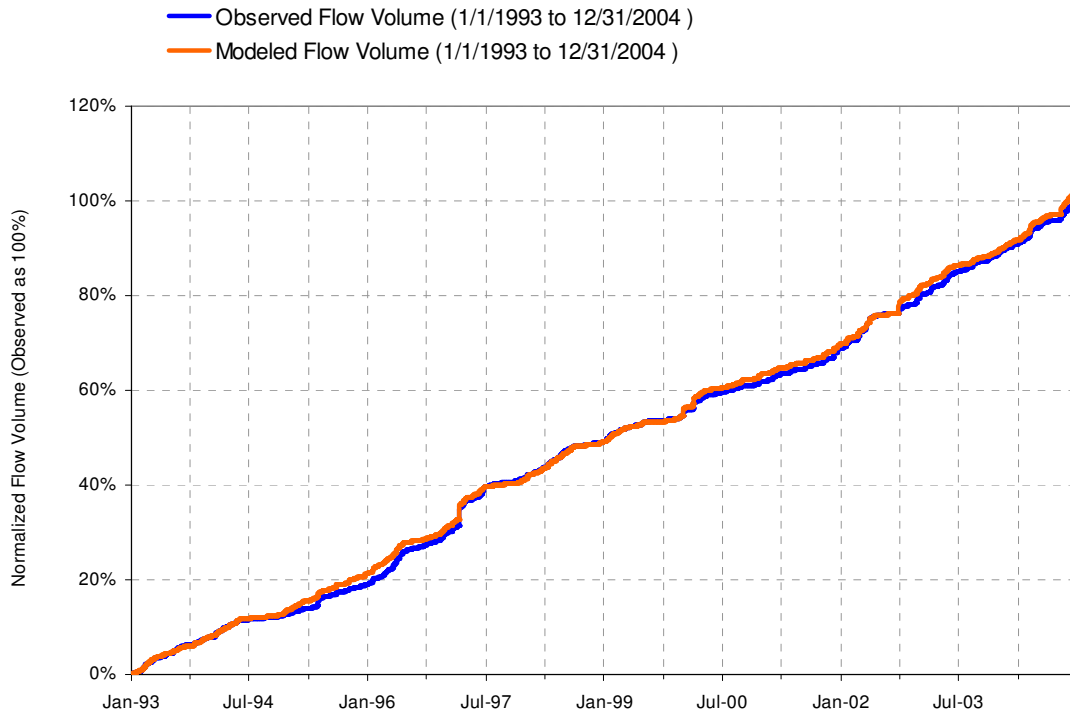
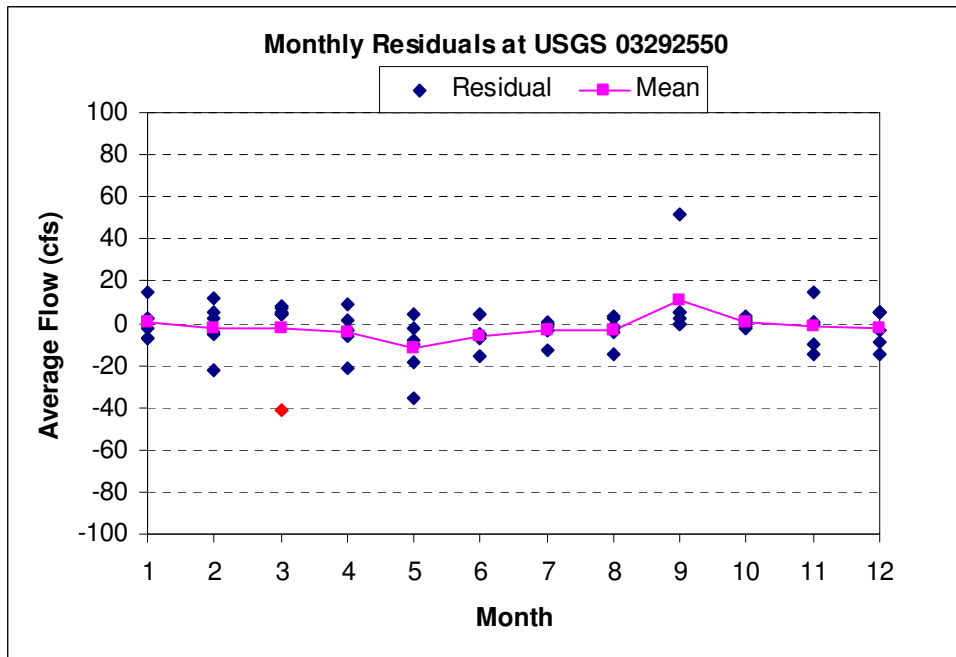


Figure C.38 Normalized Flow Residuals by Month at USGS 03292500

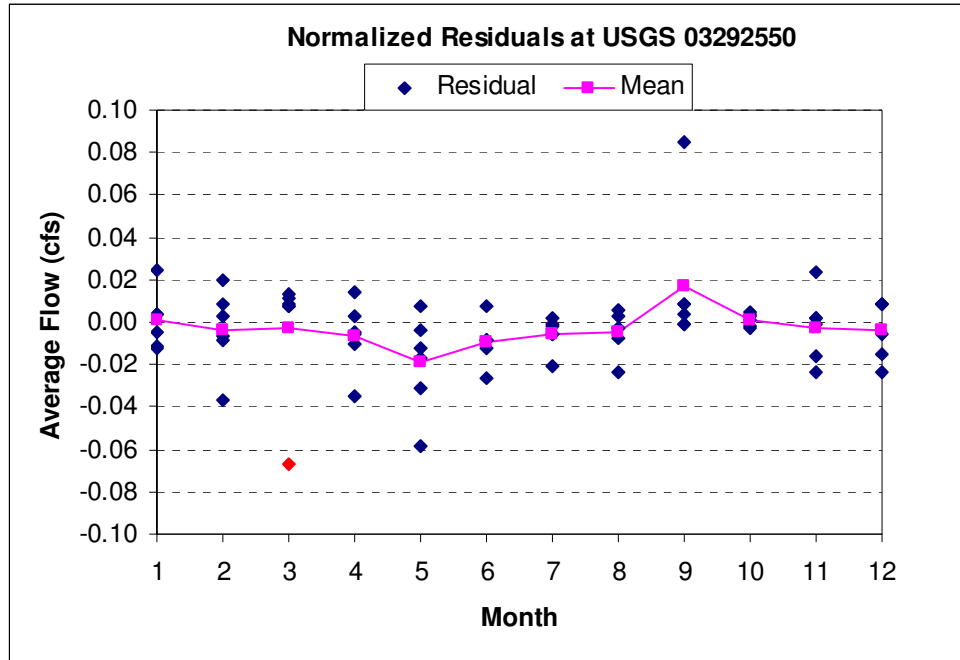


**Figure C.39 Cumulative Flow Analysis at USGS 03292500**

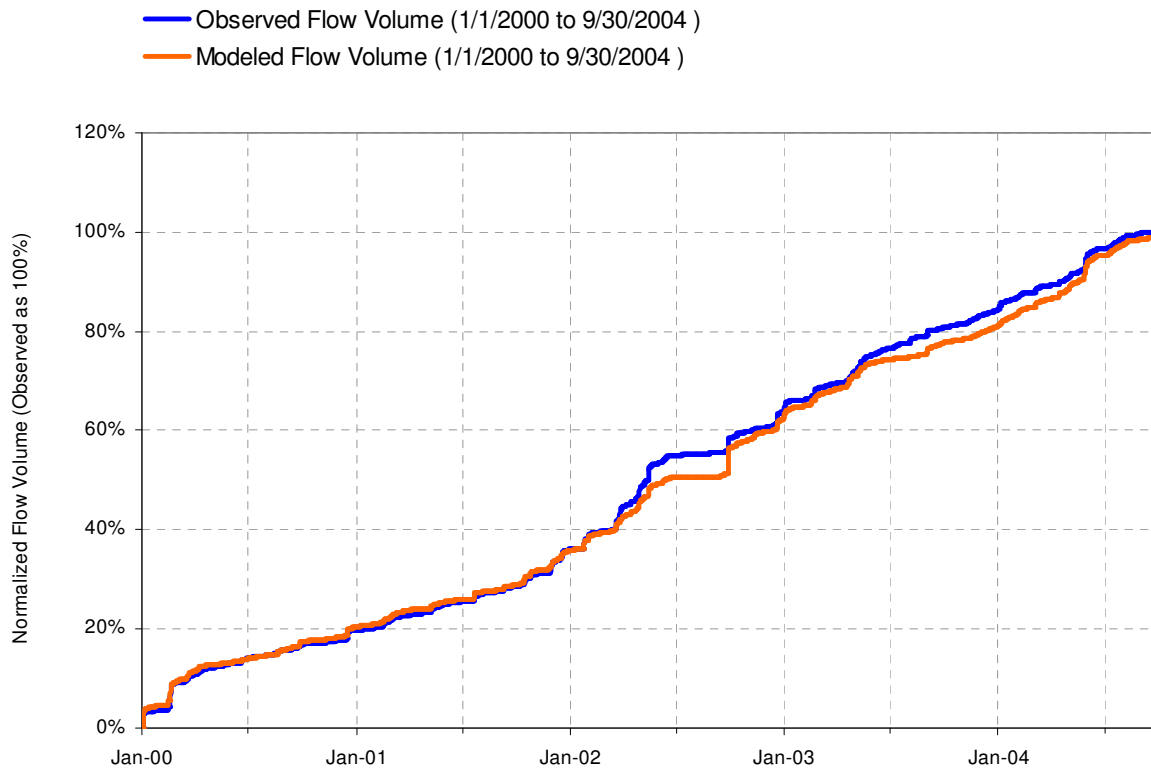


**Figure C.40 Flow Residuals by Month at USGS 03292550**

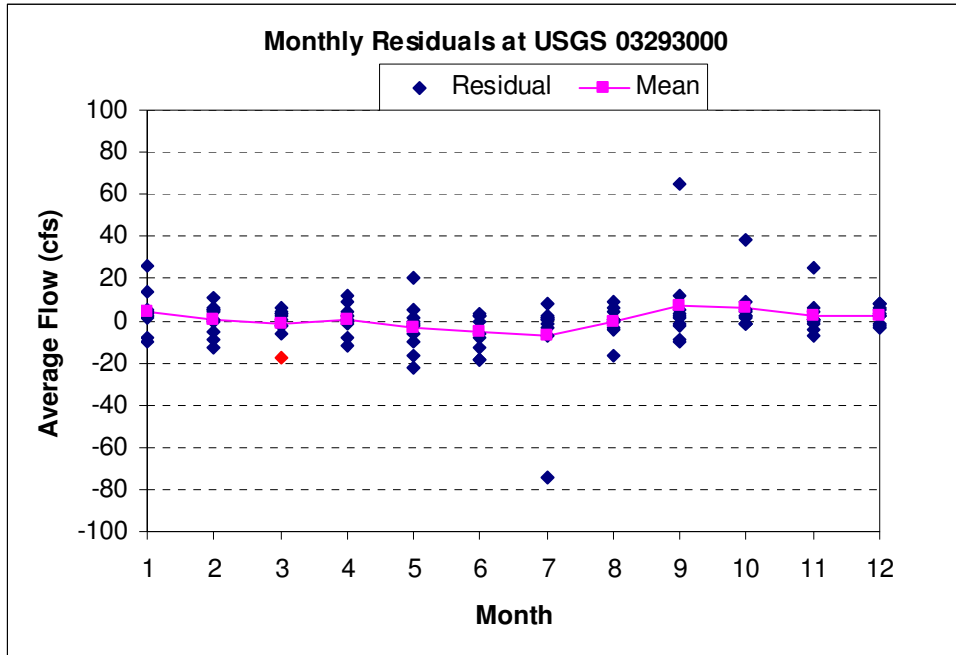




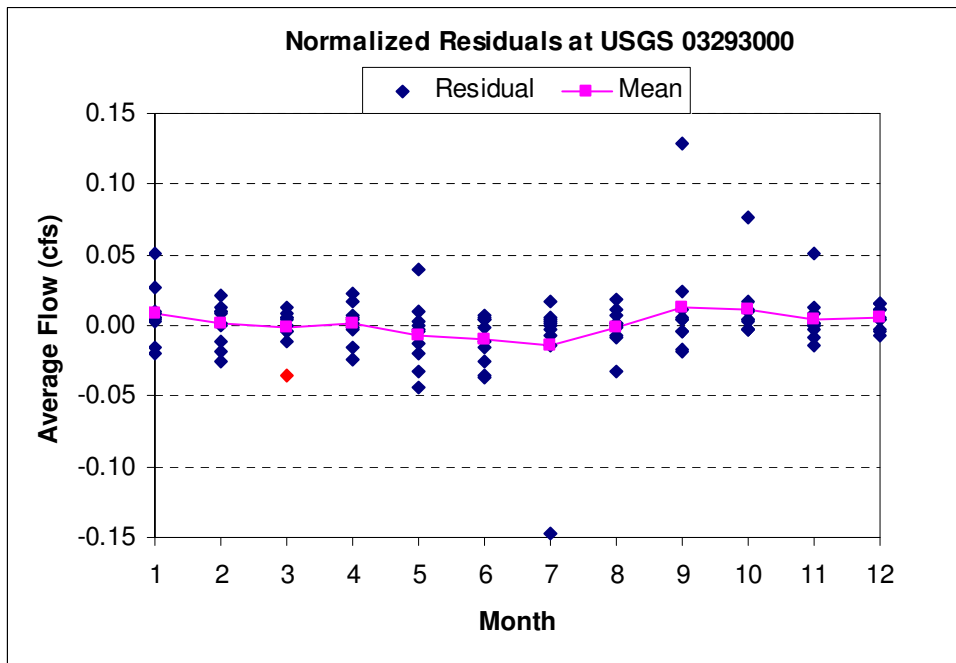
**Figure C.41 Normalized Flow Residuals by Month at USGS 03292550**



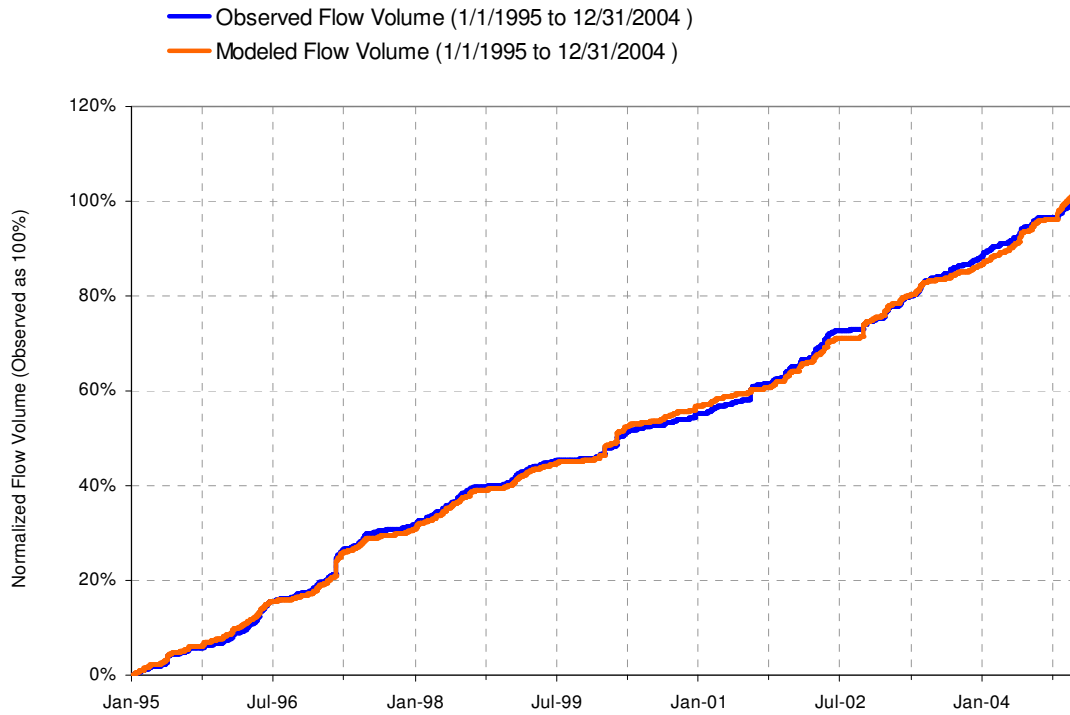
**Figure C.42 Cumulative Flow Analysis at USGS 03292550**



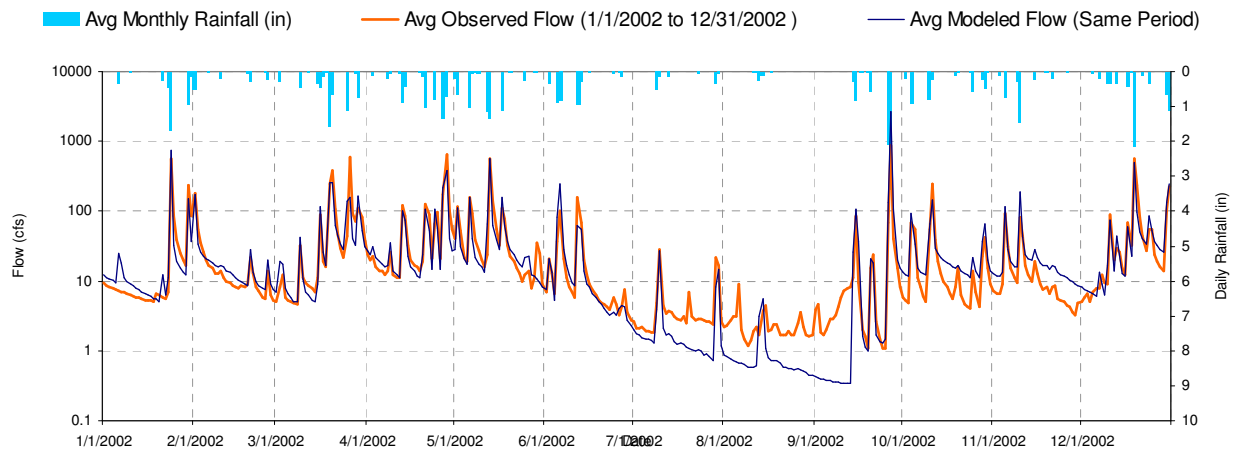
**Figure C.43 Flow Residuals by Month at USGS 03293000**



**Figure C.44 Normalized Flow Residuals by Month at USGS 03293000**



**Figure C.45 Cumulative Flow Analysis at USGS 03293000**



**Figure C.46 2002 Simulation at USGS 03292500 Showing Unobserved Summer Precipitation Events in August and September**

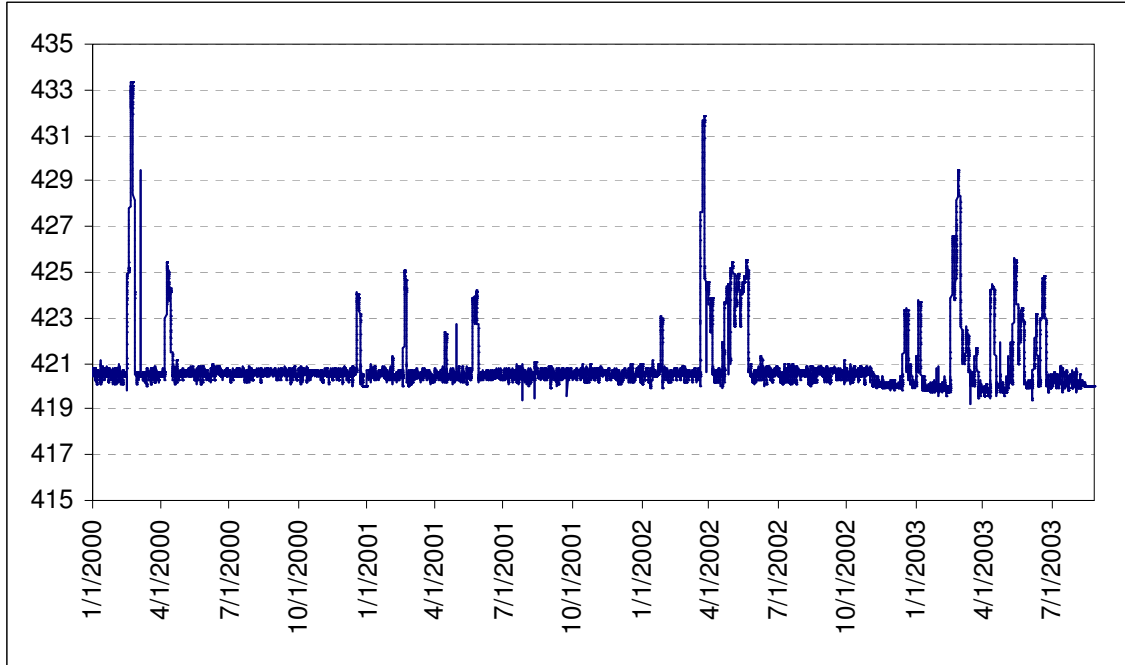
### C.6 RIV-1 Hydrology

The RIV-1 hydraulic model is specified with flow inputs from each of the three major tributaries, additional lateral flow inputs from direct drainage and CSOs, and a variable head boundary at the Ohio River derived from the McAlpine Upper stage record.

During initial testing, implementation of the RIV1 hydrodynamic model (RIV1H) revealed the need to adjust the boundaries of the modeling domain described for RIV1 in the QAPP. There it was stated that the model would be applied to *“the lower sections of Beargrass Creek extending from the mouth of Beargrass Creek upstream to the confluence of the South and Middle Forks and for the section of Muddy Fork from its confluence with the Middle Fork upstream to the crossing of Indian Hills Trail.”*

Revisions to these boundaries were required to (1) ensure that the model covers the area of reversing flows and significant backwater effects, and (2) promote model stability.

On Beargrass Creek proper, the extent of the model was reduced to reflect the area of probable backwater effect. Water table elevations in McAlpine Pool of the Ohio River are shown in Figure C.47. Most of the time, this elevation is between 420 and 422 ft MSL. The highest reading for 2000-2004 is 433.1 with only a few scattered data above 426. The one exception to this characterization is the water elevation reading of 446.7 which occurred due to the 1997 flood.



**Figure C.47 Ohio River, McAlpine Upper Stage (feet MSL)**

In the initial setup of the RIV-1 model we attempted to represent the stream network up to a minimum elevation of 434. This immediately presented problems in meeting the Froude number condition for model stability (the Froude number distinguishes the onset of supercritical flow). In practice, the model does fine with simulation of high flow conditions, however, problems are encountered during very low flows and in the transition from very low to moderate flows. Specifically, as the downstream elevation drops and the water in the upper segments is free-flowing and unconstrained by tailwater elevation, the model is unable to converge to a positive solution for depth and volume in these segments.

The critical period of interest is the low flow condition, resulting in revised the model boundaries encompassing a bottom elevation of 426 feet MSL. This required modeling the South Fork for about 0.9 miles upstream of the confluence and the Middle Fork for about 0.25 miles upstream of the confluence, while Muddy Fork would be modeled to at least 2.25 miles upstream of the confluence with Beargrass Creek. However, stability problems could not be resolved for low flow conditions at this scale either, requiring further paring of the model network. To obtain a solution that is stable over the entire 5-year period, the model network was further pared so that the upstream end of South Fork was specified at SF2.147 (invert 423.7), the upstream end of Middle Fork at MF0.214 (invert 425.3), and the upstream end of Muddy Fork at MU0.694 (invert 421.2), as shown in Figure C.48. While these elevations are less than the desired target, they are sufficient such that flow is always positive (no flow reversal) at the upstream ends of the model. Flows for the upstream end of Muddy Fork (which has the lowest elevation of the revised model) are shown in Figure C.49. Reversing flows are predicted to occur about 15 times during the 5 year simulation at the next downstream station, MU0.426. All attempts to add additional cross sections to Muddy Fork resulted in periods in which the model solution could not converge during low flows. Therefore, the revised model boundaries are the best compromise available for continuous simulation.

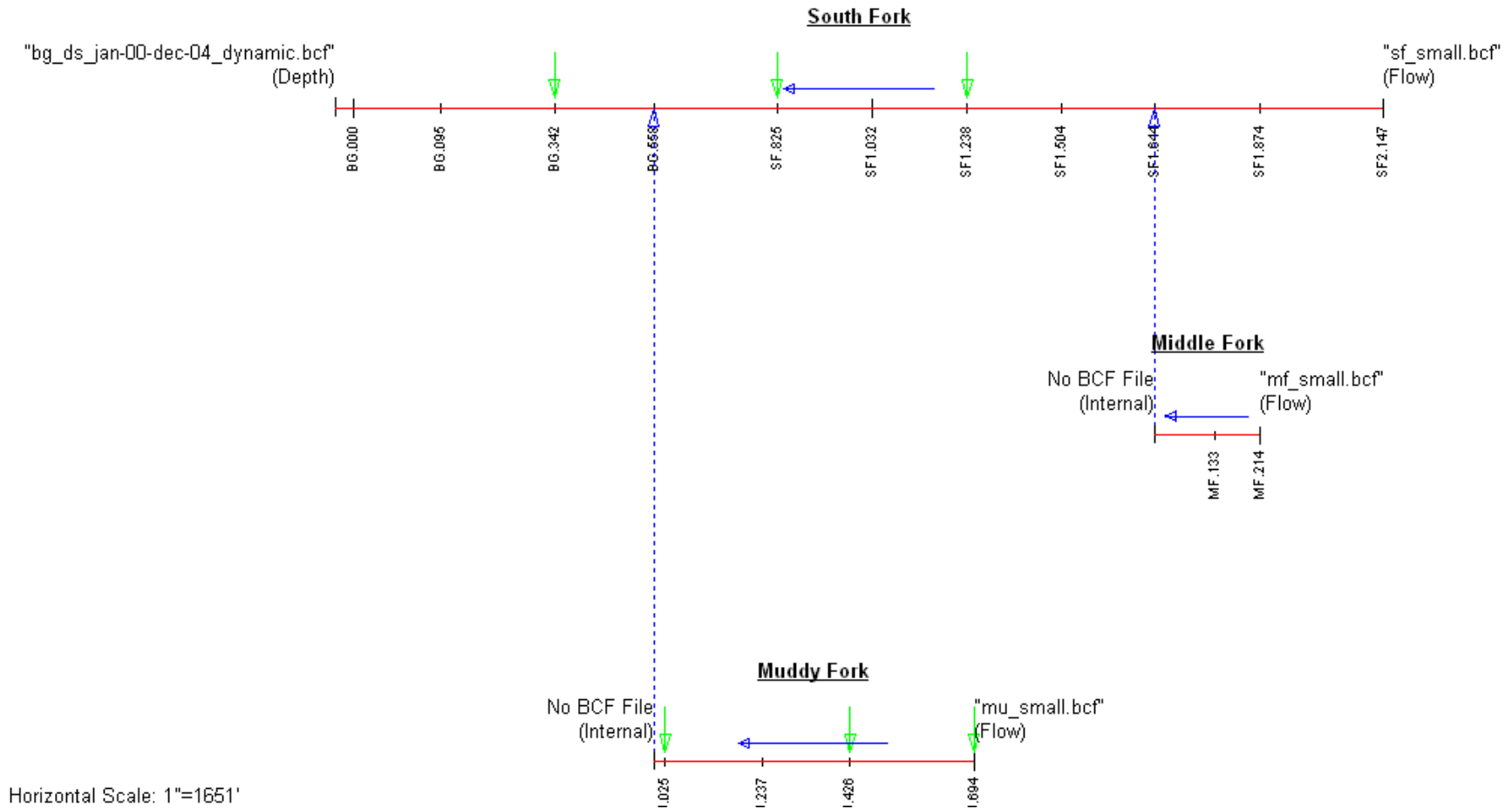
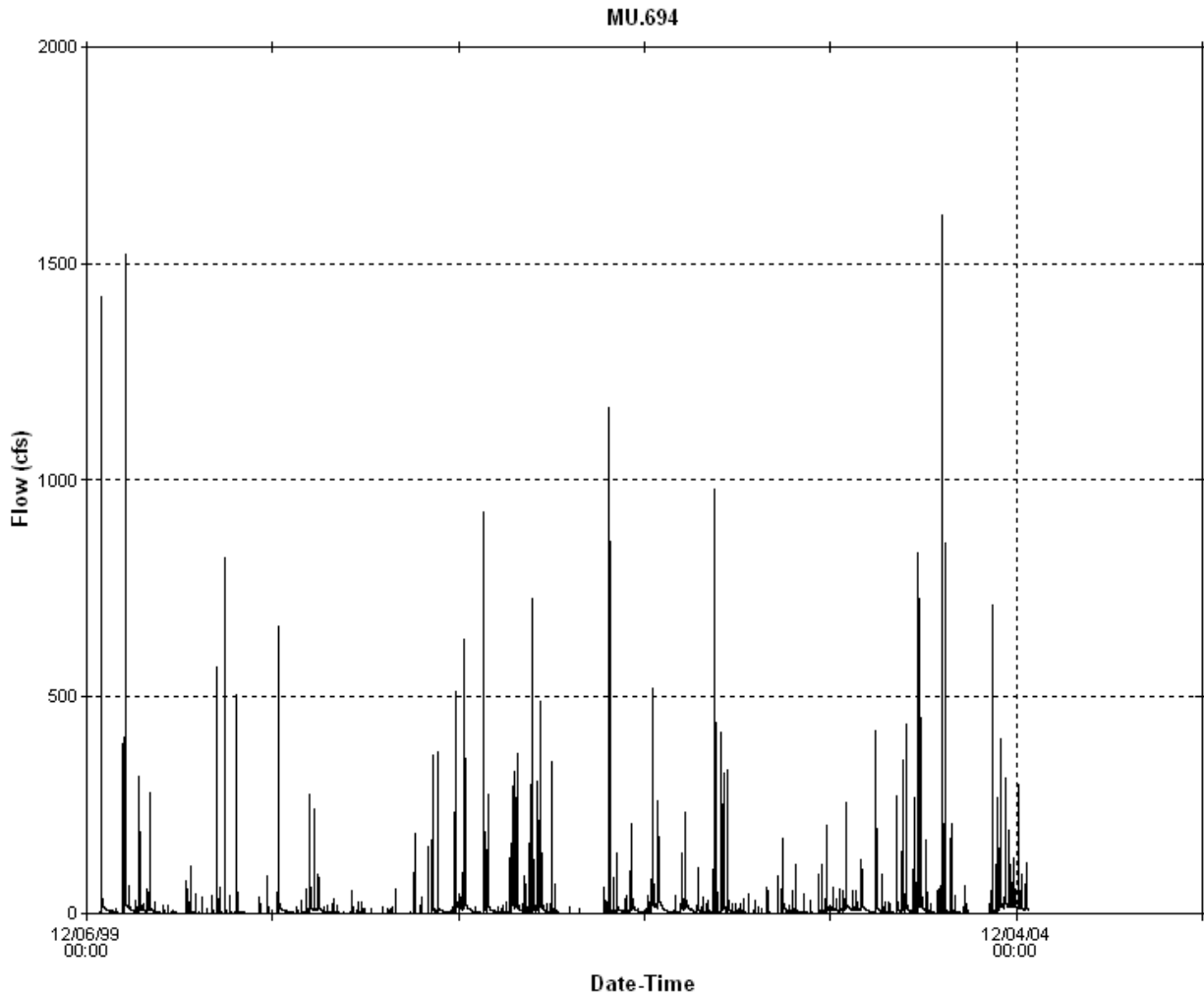


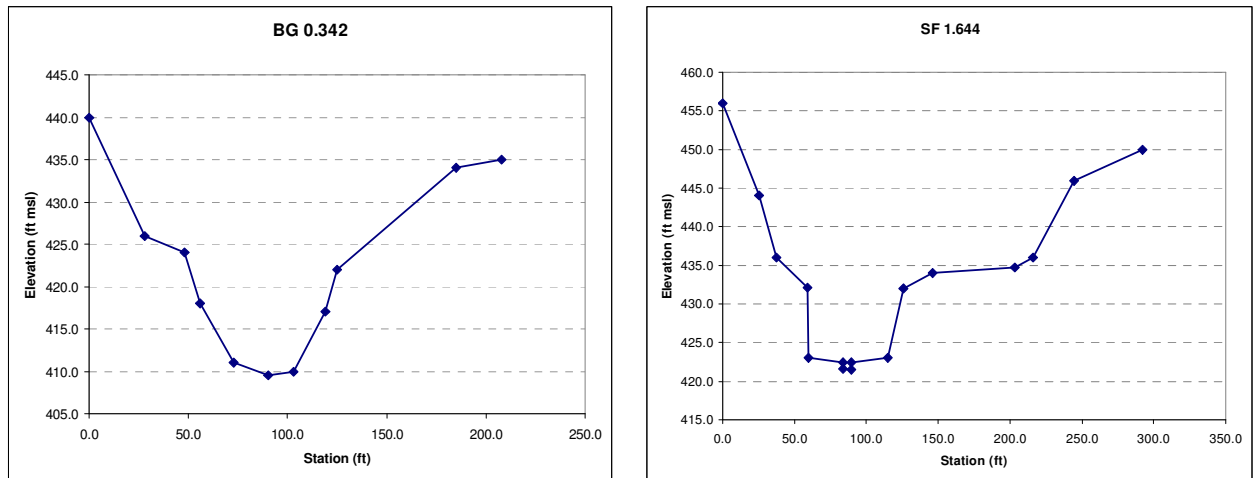
Figure C.48 Revised RIV-1 Schematic for Beargrass Creek



**Figure C.49 Flows at Cross Section MU0.694.**

As a result of these findings, redefining the boundaries was necessary between the HSPF and RIV-1 models (Figure C.48). The upstream ends of the RIV-1 revised network are located within the downstream end of HSPF Reach 600 for South Fork, the downstream end of Reach 780 for Middle Fork, and the middle of Reach 900 for Muddy Fork. The HSPF model is therefore carried down to these points. Outputs from Reach 600 and 780 are directly used as boundary conditions for South and Middle Fork, respectively – and the small contributing areas that are actually downstream of the boundary are counted as part of the boundary condition. The outputs from HSPF reaches 920, 910 and the upland runoff from the northeastern portion of sub-basin 900 are combined to force the upstream end of Muddy Fork. HSPF also provides simulation of upland runoff to the RIV-1 domain, which is inserted into the model as lateral input files. It is believed that the reconfigured model provides the maximum extent that can successfully be simulated by the RIV-1 model. As the network still covers the full area of reversing flows, this is sufficient to meet the modeling objectives specified in the QAPP.

Reach geometry for the model was set up using existing HEC models plus additional surveying. The cross sections reflect the varied geometry of natural channels and artificial concrete channels (Figure C.50).

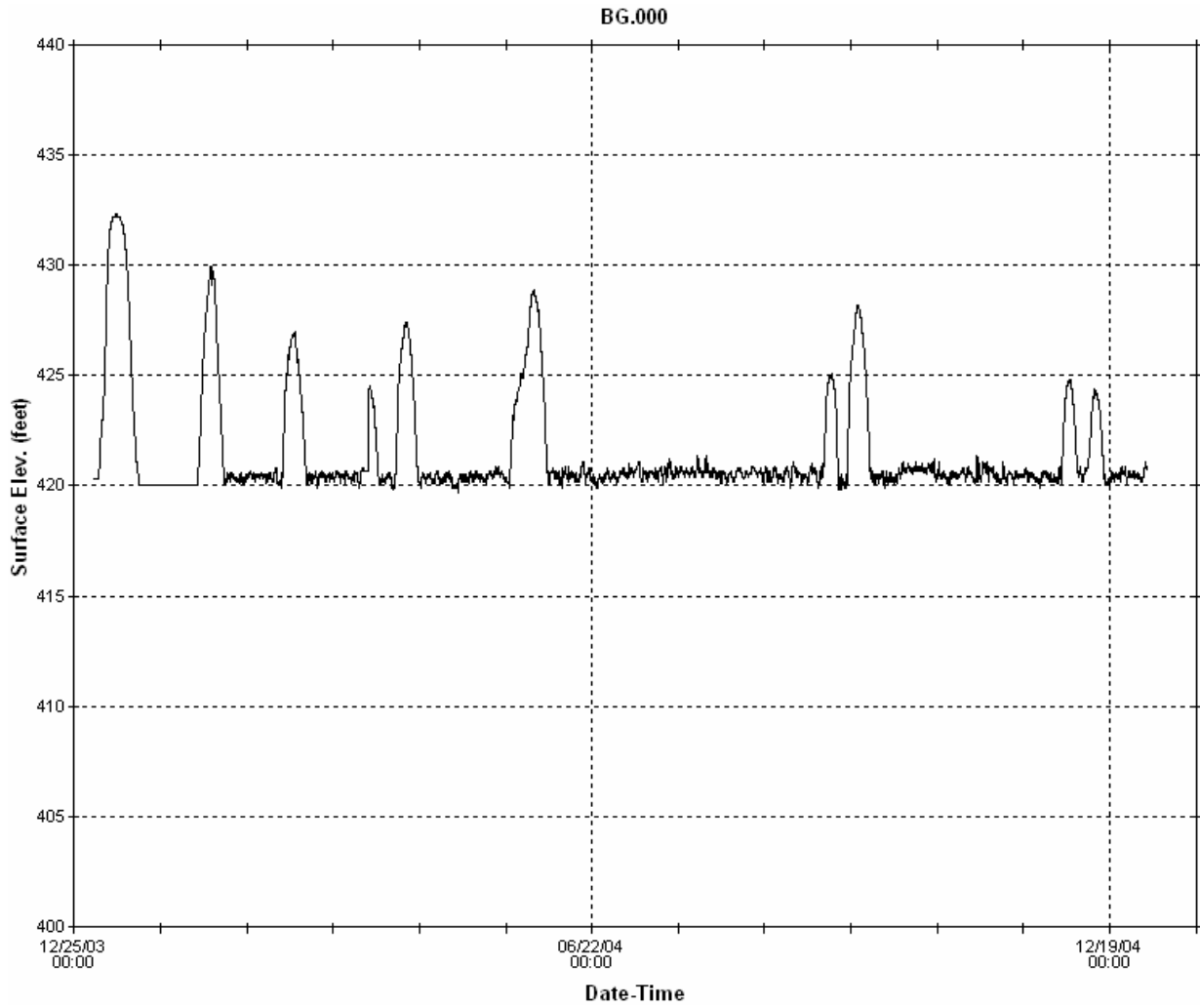


**Figure C.50 Representative Cross Sections, Showing Natural Channels (Left) and Concrete Channels (Right)**

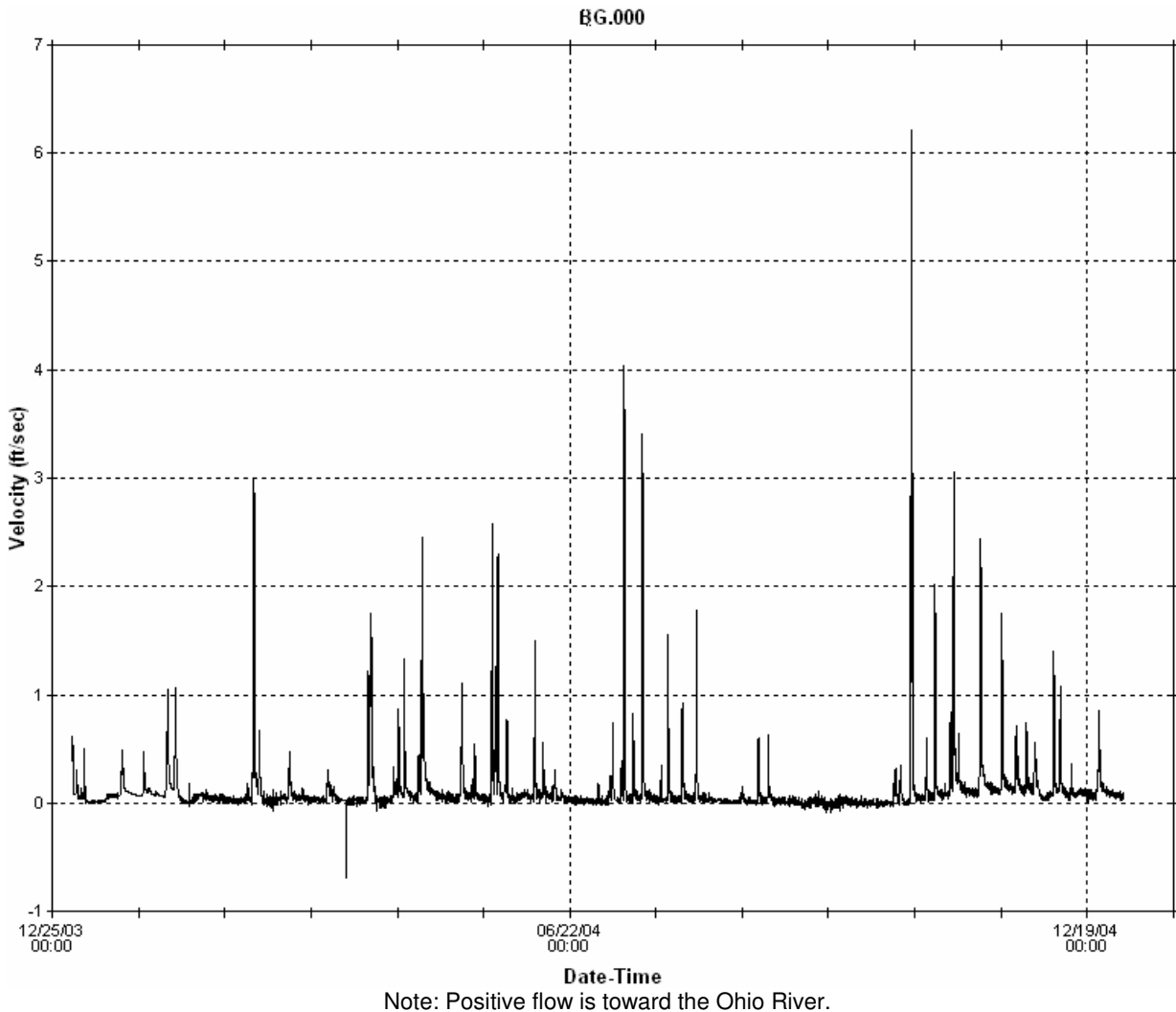
Manning's roughness coefficients were specified based on bed type, and ranged from a low of 0.018 in the concrete channel sections to 0.06 in portions of Muddy Fork where significant obstructions and vegetation are often present (Arcement and Schneider, 1989). For the RIV-1H simulation, a 30 s time step was found to be sufficient to meet both Froude and Courant number limits on model stability for the 2000-2004 simulation period.

At the mouth of Beargrass Creek, elevations are largely controlled by stage in the Ohio River (see Figure C.51). Small reversing flows are predicted to occur frequently; however, the major effect of elevated stage in the Ohio is to back up water in lower Beargrass Creek. Significant reverse flows are predicted to occur only occasionally, when high stage in the Ohio is not accompanied by corresponding high upstream flows in Beargrass Creek (see Figure C.52).





**Figure C.51 Predicted Water Surface Elevation at the Mouth of Beargrass Creek, 2004**



**Figure C.52 Predicted Water Velocity at the Mouth of Beargrass Creek, 2004**

No flow gaging is present in Beargrass Creek near the mouth within the RIV-1/WASP model domain. The standard procedure of estimating flow from stage is not applicable here because of the strong backwater effect from the Ohio River including reversing flows. Instead, relevant calibration data for this region of the model would consist of water surface elevations and velocities.

Unfortunately, very little monitoring of this type has been conducted. USEPA (2002) undertook a few days of stage and flow velocity measurements in lower Beargrass Creek in August 2002 in conjunction with a DO study, as did Hydro2 in 2005 (the latter unfortunately after the period of this model). USGS (2003) did an informal evaluation of flow characteristics in lower Beargrass Creek over an 11-day period. The evaluation included monitoring stage and velocity in 2003, with the purpose of further investigating the 2002 findings of USEPA. There are thus only a few days of flow monitoring available for the RIV-1 domain during the model calibration and validation period. From the information that is available the RIV-1 model reproduces the average stage and

velocity reported in 2002 and 2003 – but the data are far from sufficient to form the basis of a formal evaluation.

One intriguing aspect of all three studies in lower Beargrass Creek is documentation of a highly regular oscillation in stage, which results in flow reversals when upstream flows are small. For instance, in August 2002 USEPA (2002) documented water level oscillations of about  $\pm 0.2$  ft near station ESFSF006, with corresponding reversals in velocity (Figure C.53).

USGS (2003) re-examined this issue and confirmed the presence of the water level oscillations. They further documented that the oscillations appear to proceed upstream from the Ohio River boundary. Unfortunately, USGS was unable to establish any connection between the water level oscillations and obvious proximate causes, such as dam and lock operation or peaking hydropower generation. One possibility is that the regular oscillations could result from industrial pumping (perhaps from ground water via a karst connection to surface water), but this is only speculative.

The water level oscillations and corresponding short-term flow reversals are an unexplained, but significant component of the hydrology of lower Beargrass Creek. Unfortunately, the McAlpine Pool stage records that provide the downstream boundary conditions for the RIV-1 model are reported on an hourly basis – too sparse to represent oscillations that occur at a 30-min phase. The present model thus cannot represent this fine scale hydrologic behavior (and, indeed, representation of flow reversals at this scale would likely require uses of a hydrodynamic model that is more sophisticated and robust than RIV-1 to maintain stability).

The oscillations and flow reversals likely occur only during conditions of low upstream flow, but can clearly have an important impact on water quality during low flow conditions. The effects of the “sloshing” is primarily to enhance longitudinal mixing, and thus can be addressed, on average, through the specification of longitudinal macrodispersion constants, as is commonly done in estuarine models. The impacts on DO, however, appear to represent more than simple longitudinal mixing. Summer DO often approaches zero in lower Beargrass Creek and the USEPA 2002 study documented increased DO deficit in conjunction with the low phase of the water level oscillation.

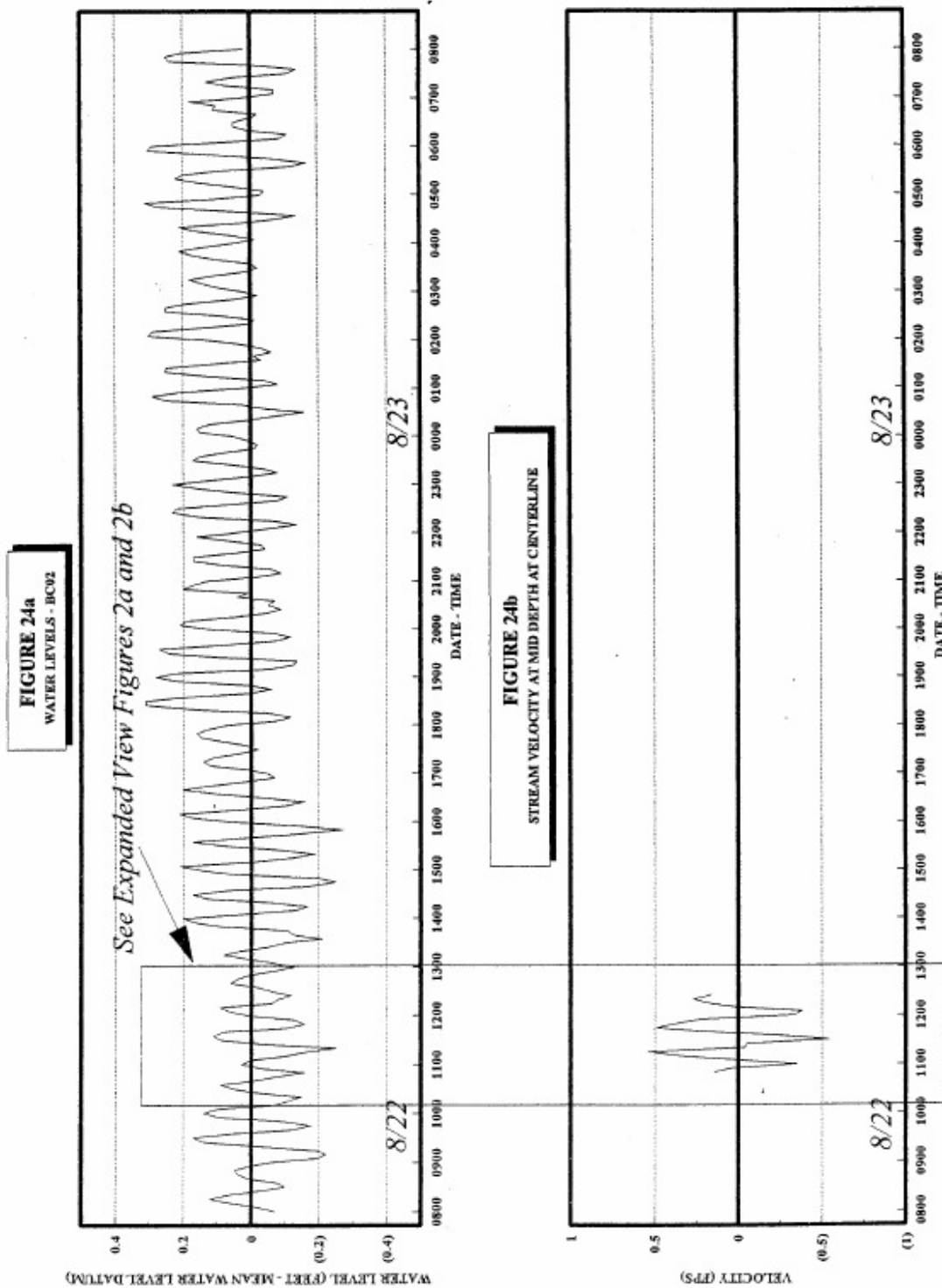


Figure C.53 Water Level Oscillations, Beargrass Creek at Brownsboro Road, August 2002 (from USEPA, 2002)

**APPENDIX D: WATER QUALITY CALIBRATION/VALIDATION  
OF THE WQT**

## D.1 Bacterial Calibration Approach

Simulation of fecal coliform bacteria concentrations often presents a challenge for watershed modeling. Observed concentrations tend to be highly variable in both space and time due to natural variability and analytical uncertainty. Further, in-stream concentrations may be elevated by sources which are not explicitly included in the model (e.g., illicit discharges, water fowl, wildlife), or which may be included in the model in a general way, but have large and unmonitored variability (e.g., intermittent loads from sanitary sewer overflows). The watershed models represent average loads from the land surface as a buildup/washoff process.

In addition to surface washoff, the model includes subsurface contributions by assigning concentrations to groundwater and interflow discharge. Loads from CSOs are represented in the SWMM model and loaded back into HSPF. SSO loads were specified from a separate model application.

Fecal coliform accumulation rates for developed pervious and impervious surfaces were initially specified based on previous successful modeling applications and reflect the range of values given by the Natural Resources Conservation Service (NRCS)/USEPA bacteria indicator tool spreadsheet (USEPA, 2000) with typical pet densities (accumulation rates on the order of  $5.3 \times 10^9$  organisms/acre/day).

As with sediment, the fecal coliform bacterial calibration began with a pre-calibration step in which the loading rates from the land surface were adjusted to approximate loading rates by land use consistent with estimated mean concentrations (EMCs) derived from the National Stormwater Quality Database (NSQD). These initial values were subsequently adjusted upward to provide a better match to observed in-stream data during model calibration (Table D.1).

Within the stream network, fecal coliform bacteria are subject to dieoff specified as a temperature-dependent first-order reaction rate. As these organisms reside in the mammalian gut, they do not prosper in surface waters. Die off rates are increased by a variety of factors including temperature, sunlight, salinity, and predation. HSPF automatically accounts for temperature, but not the other factors influencing die-off rate. Mancini (1978) suggests a base loss rate of 0.8 per day, with increases above the base rate due to the influence of these factors, typically resulting in a final value less than 2 in freshwater. Based on experience with similar models, a loss rate of 1.15 per day in the water column appears to provide a reasonable fit to observations. Fecal coliform concentrations in streams during baseflow can be simulated based on a combination of recycling from organic sediment and ground water loading. In recycling from the sediment, observed concentrations at baseflow are a function of prior loading. Coliform bacteria may be stored in stream sediment, where they experience a lower die off rate, and diffuse back into the water column, resulting in a slower recovery of stream concentrations to baseflow levels after washoff events (Thomann and Mueller, 1987, Section 5.3.1). Accordingly, fecal coliform bacteria within stream reaches were simulated as weakly sediment-associated with the silt fraction and with a lower decay rate (0.16 per day) while in storage in the streambed. The fecal coliform simulation in the WASP model was set up to match the conceptual model and reaction rates used in the HSPF model, although some of the parameters use different units.

**Table D.1 Comparison of Upland Fecal Coliform Loading Rates**

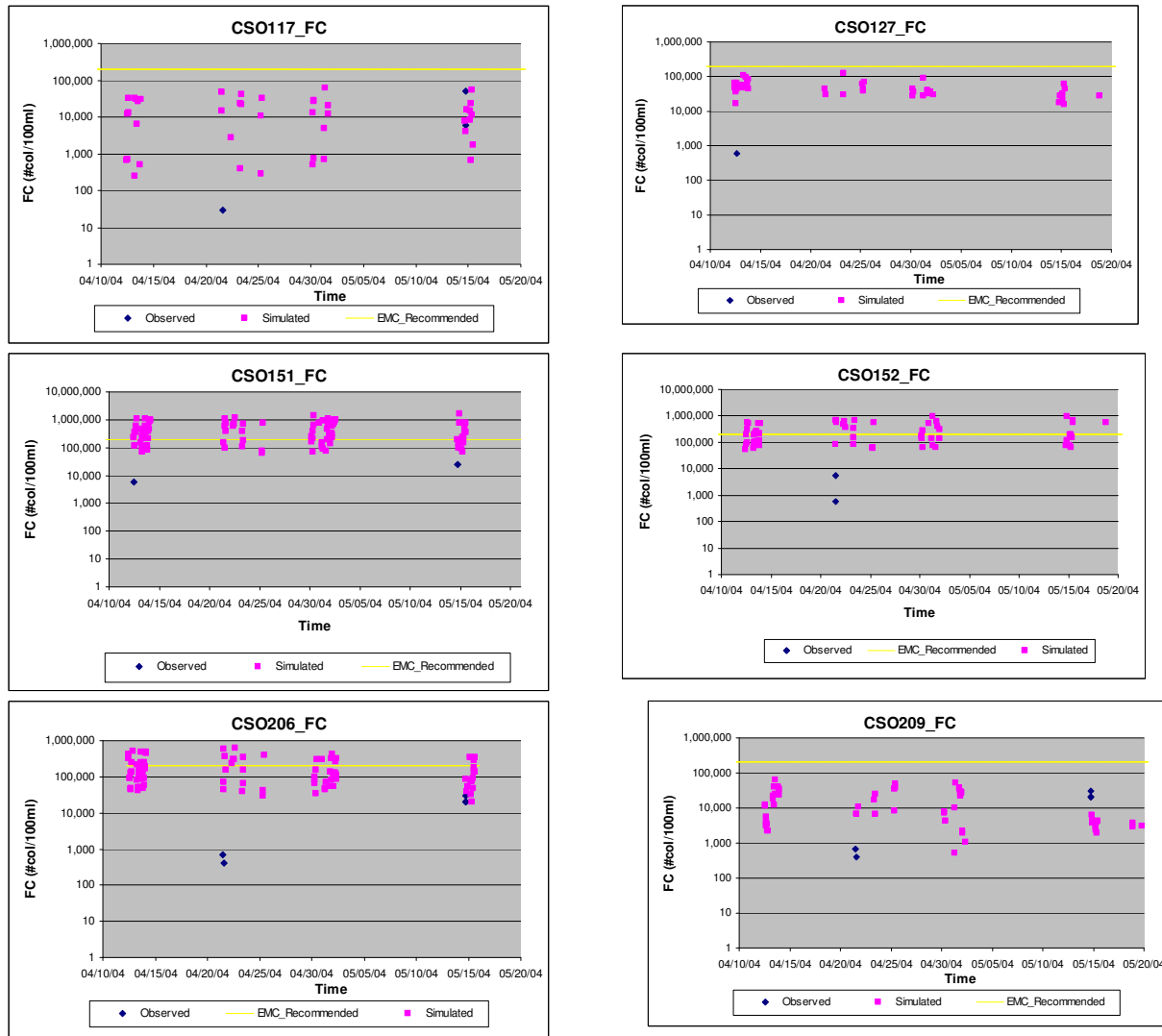
Land Use	NSQD (#/ac/yr)	Initial Model (#/ac/yr)	Ratio (NSQD:Model)	Final Model (#/ac/yr)
SFR	1.93E+11	1.94E+11	100%	3.51E+11
MFR	2.70E+11	3.09E+11	88%	5.53E+11
Comm	3.04E+11	3.19E+11	95%	6.54E+11
Ind	2.26E+11	2.26E+11	100%	5.05E+11
Inst	2.35E+11	2.39E+11	98%	4.43E+11
Parks	5.41E+10	5.63E+10	96%	8.05E+10
Trans	1.52E+11	1.51E+11	101%	2.61E+11
Vacant	6.16E+10	5.89E+10	104%	8.45E+10

## D.2 Combined Sewer System Calibration

The initial simulation for the CSS water quality calibration was performed using the dry weather flow concentrations recommended in the QAPP and the wet weather runoff flows and concentrations provided by the HSPF model. The initial model results indicated that the fecal coliform concentrations assigned to the dry weather were higher than the actual concentrations monitored in the system (based on limited sampling in April 2004). The initial model results for concentrations in CSOs were, on average, an order of magnitude greater than the EMC specified in the QAPP as representing typical CSO concentrations and the limited available observed data.

The final simulation for the water quality calibration was performed mainly by adjusting the dry weather flow concentration for fecal coliform within the CSS model in an attempt to match the fecal coliform better to the observed and EMC recommended values. The revised fecal coliform input concentration was input at the value obtained from extremely limited sampling data collected during dry weather in 2001. As a result of this process, the dry weather flow concentration was reduced from 1.0E+9 to 1.56E+6 organisms per 100 mL.

There were a total of nine CSO locations with very limited water quality sampling data available for the calibration. The sampling data from the month of April 2004 at six CSO locations are compared to the adjusted model results in Figure D.1.



**Figure D.1 Combined Sewer System Model Fecal Coliform Calibration Results**

Fecal coliform concentrations in SSOs were set at 3.75E+5 per 100 mL, which is the value recommended in the QAPP and also the average of intensive MSD sampling of pumped SSOs on 2/15/03, 2/21/03, 9/2/03, 9/3/03, 12/18/02.

### D.3 In-stream Calibration and Validation

In addition to standard manual calibration approach, the dry-weather (subsurface) concentrations and impervious surface loads of fecal coliform bacteria were optimized using PEST. PEST (Watermark Numerical Computing, 2002) is a flexible optimization shell that can be used to numerically fit parameters for HSPF and other simulation programs. This optimization initially focused on minimizing the relative absolute error. Based on comments received on the draft calibration, the model fit was subsequently adjusted to focus on the objectives specified in the QAPP (fitting observations greater than 200 MPN per 100 mL within 0.5 and 1 log units) at the



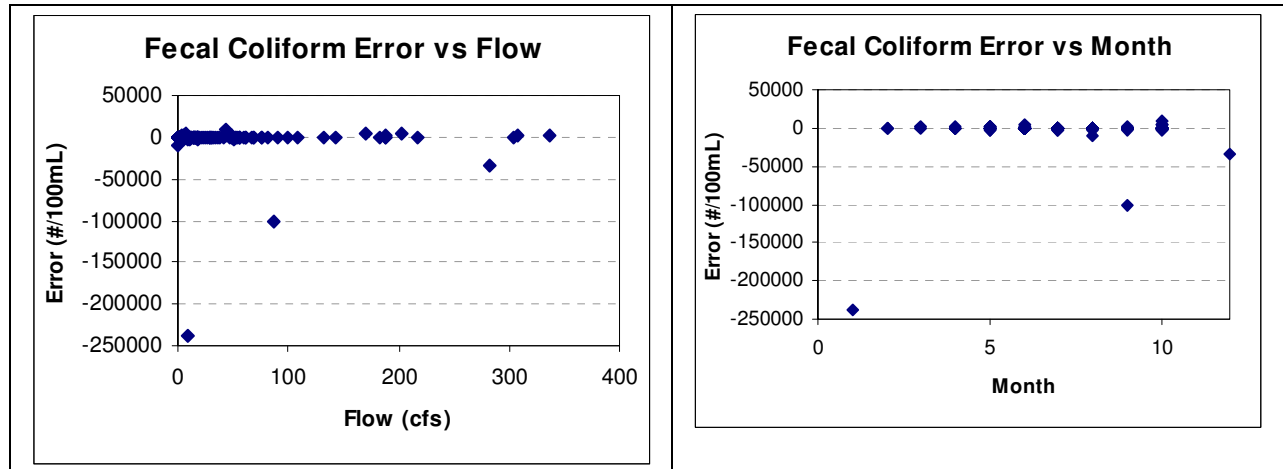
expense of a small decline in the fit for low reported concentrations (less than 200 per 100 mL) and slightly higher relative absolute errors.

The basic calibration statistics for fecal coliform are shown in Table D.2. The median errors are all near zero (indicating bias is not significant). Most of the average errors are less than zero, but are largely driven by a few observations where the model under-predicted observations by a large amount. (This is a situation frequently encountered for variables whose error distribution is approximately lognormal).

**Table D.2 Calibration and Validation Statistics  
for Fecal Coliform Bacteria (#/100 mL)**

Statistic		SF01	SF02	SF06	MI02	MI04	MU02	MU04
Sample Count (days)		166	166	74	136	11	110	112
Full Period (2000-2004)	Average error	-1773	-2182	-12808	-2975	-42266	319	-178
	Median error	32	0	0	29	-40	14	5
	Median absolute error	73	102	291	164	7893	49	50
Calibration (2000-2003)	Relative absolute error	1.33%	0.93%	2.37%	2.19%	11.8%	21.6%	8.15%
Validation (2004)	Relative absolute error	1.47%	0.74%	1.02%	2.24%	ND	6.70%	1.34%
Observations > 200/100 mL	Predicted within 0.5 log units	63.6%	84.3%	64.2%	78.9%	88.9%	71.3%	58.4%
	Predicted within 1.0 log units	78.2%	96.5%	91.4%	96.3%	100%	97.3%	79.2%

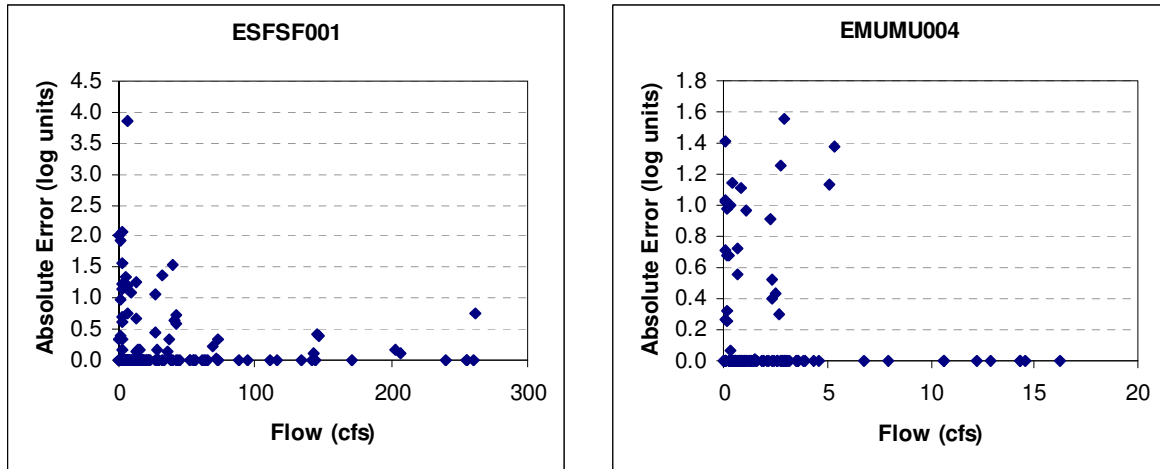
Particular attention was paid to minimizing potential bias relative to flow regime or season by plotting prediction error versus flow and month. Typical results are shown for station ESFSF002 (South Fork, within the CSSA) in Figure D.2. As with other stations, the errors are generally close to zero, but there are several outliers present with very large individual errors.



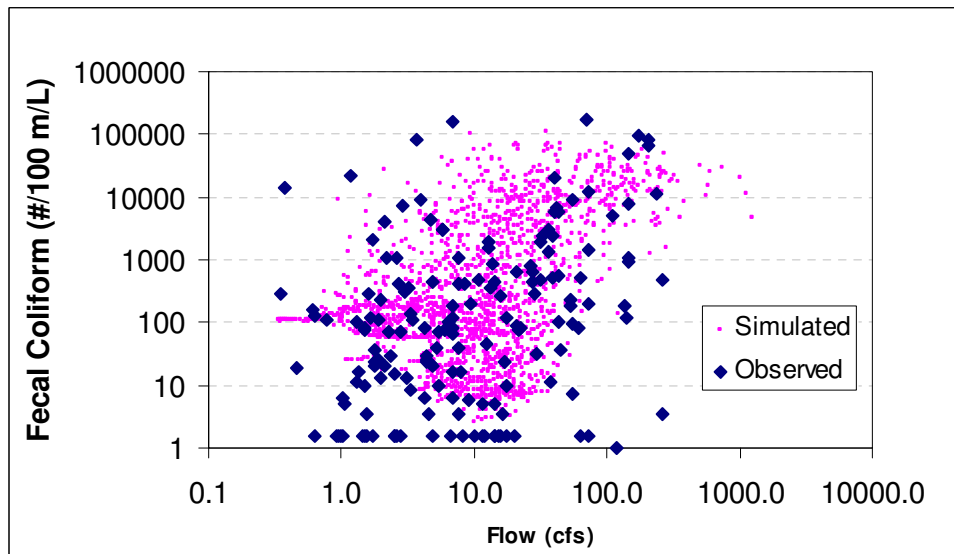
**Figure D.2 Fecal Coliform Prediction Errors Plotted against Flow and Month  
for Station ESFSF002**

It has not been possible to achieve the desired tolerance targets for predicting fecal coliform concentrations greater than 200 per 100 mL within 0.5 log (80%) and within 1.0 log (95%) at all sites. Examination of the relationship of the log space absolute error shows that the majority of the large errors at some stations occur at low flows (Figure D.3). Specifically, very high concentrations have often been observed in-stream, upstream of the CSSA, in the absence of concurrent or recent runoff events. These high concentrations are sporadic and they cannot be represented via assignment of concentrations to groundwater discharge. For example, a concentration of 7,500 per 100 mL was reported at ESFSF001 on 9/13/04. At this time the flow at the South Fork gage was 4.1 cfs and falling, and there had been no rain in the prior 4 days (and only 0.004 inches in the prior week). These sporadic high observations may be due to unreported SSOs, illicit connections, or animal sources – none of which can readily be represented in the model.

The model does generally predict high concentrations within 0.5 log units or less when flow is greater than about 50 cfs (Figure D.3). Plots of observed and predicted fecal coliform concentration versus flow (e.g., Figure D.4) reveal a similar issue. The model reproduces the general trend of the data, but there are sporadic high concentrations at low flows. There are also reported non-detects at all flow ranges (plotted at one-half of the detection limit), which impeded the overall fit but do not affect the statistics for concentrations greater than 200 per 100 mL.



**Figure D.3 Relationship of Absolute Error (Log Basis) for Fecal Coliform Predictions to Flow (Observed Concentrations Greater Than 200/100 mL only)**



**Figure D.4 Fecal Coliform Concentration Versus Flow, ESFSF001**

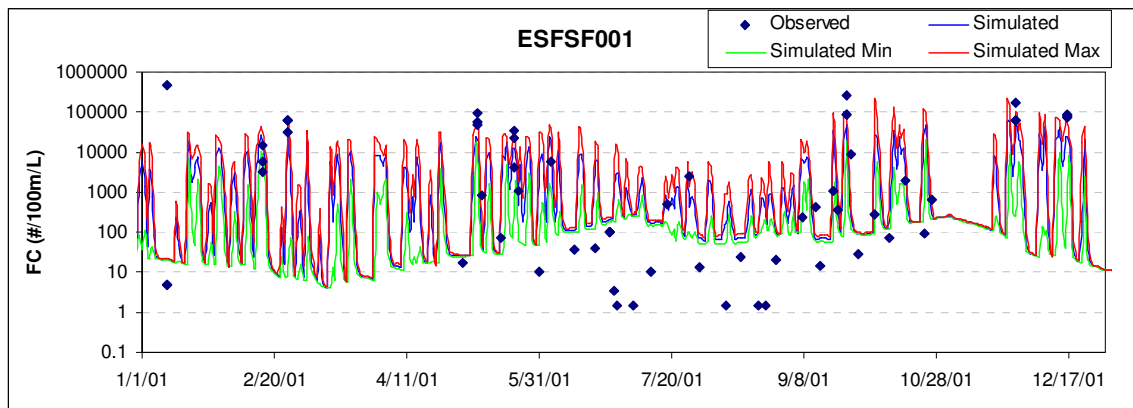
If the lowest flows are eliminated (flow below 10 cfs for the larger South and Middle Fork watersheds and flows below 5 cfs for the smaller Muddy Fork watershed) the percentage of observations predicted within the specified number of log units increases substantially (Table D.3), although still not meeting all of the tolerance targets. Performance does not improve at station SF06 and MI02 because the largest errors there are primarily associated with moderate flows – suggesting that some CSO events are not simulated by the model.

**Table D.3 Prediction Statistics for Fecal Coliform Bacteria (#/100 mL) at Higher Flows**

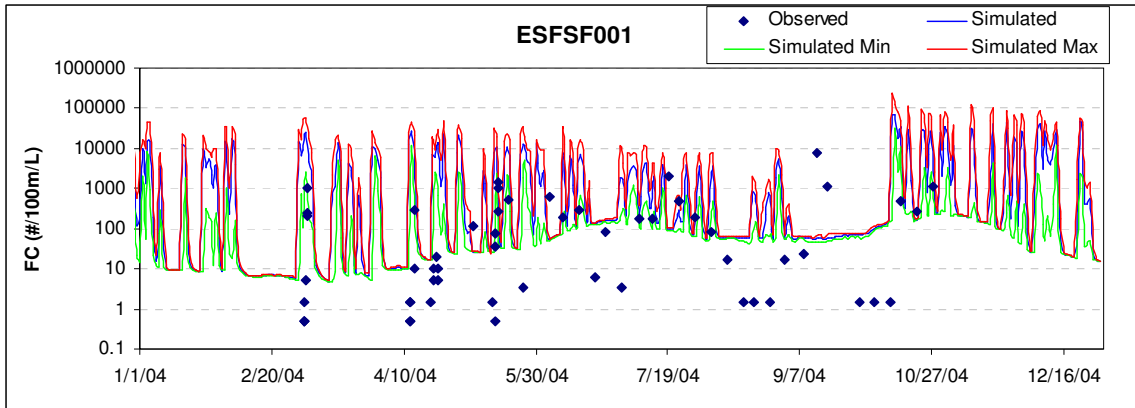
Statistic		SF01	SF02	SF06	MI02	MI04	MU02	MU04
Observations > 200/100 mL	Predicted within 0.5 log units	77.8%	90.3%	64.7%	77.9%	88.9%	92.8%	74.1%
	Predicted within 1.0 log units	91.9%	99.0%	92.6%	97.4%	100%	100%	81.3%

As with other constituents, calibration and validation plots are shown for years 2001 and 2004, the years with the greatest amounts of data (Figure D.5 through Figure D.17). The model fits the general trend, but is subject to the various issues noted above. During April 2004 extremely low concentrations are reported at almost all stations, suggesting that there might have been analytical problems with the growth test. A single seasonal pattern for baseflow concentrations is applied to both South and Middle Fork. This does a reasonable job of representing concentrations in excess of 200 per 100 mL, but tends to over predict summer baseflow concentrations below 200 at some stations. Finally, event peak concentrations in the CSSA appear to have been higher in 2001 than in 2004. The recalibration of the model compromises between the elevated peak concentrations seen in 2001 and the more moderate peaks seen in 2004.

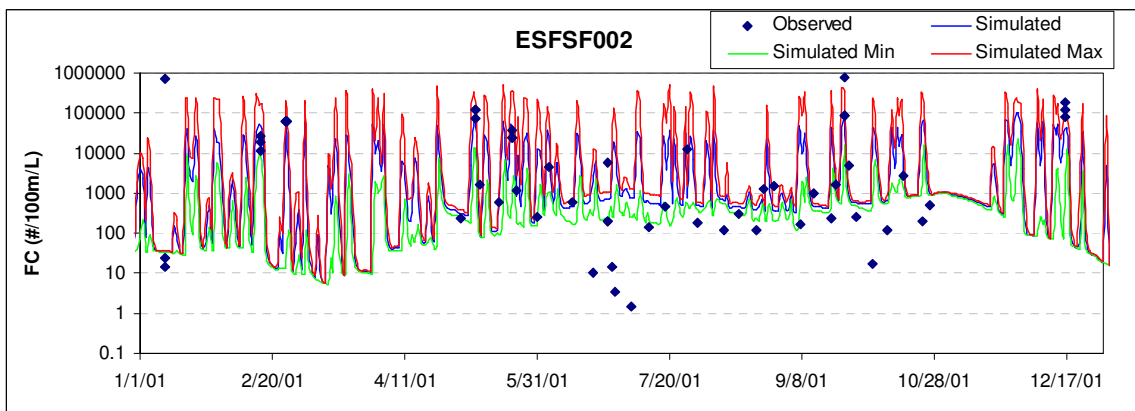
Sampling on South Fork and Middle Fork has often focused on capturing storm runoff events. In contrast, sampling on Muddy Fork has been performed on a regular schedule, which has resulted in almost no large runoff events being sampled at Muddy Fork stations.



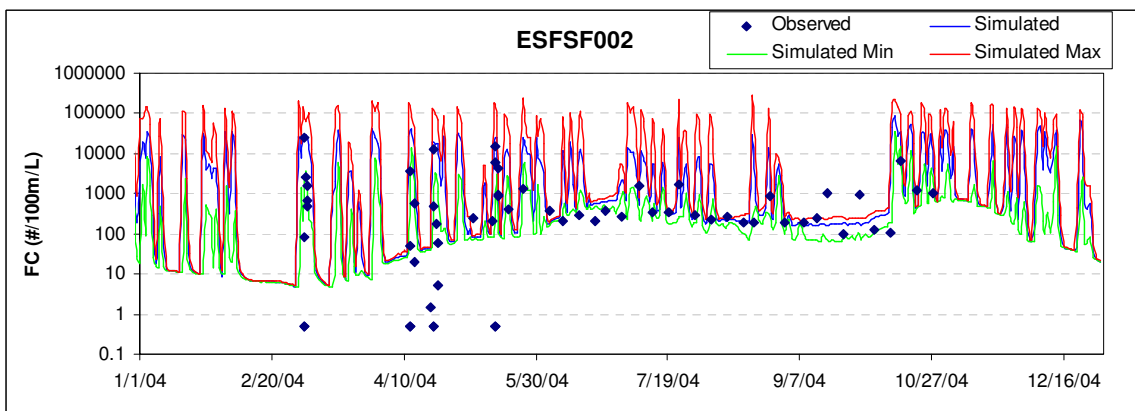
**Figure D.5 2001 Calibration Plot for Fecal Coliform at Station ESFSF001**



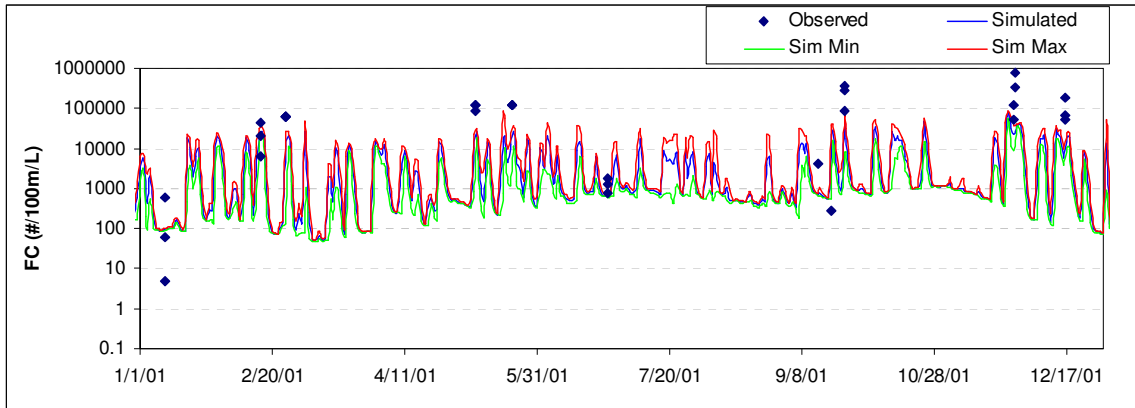
**Figure D.6 2004 Validation Plot for Fecal Coliform at Station ESFSF001**



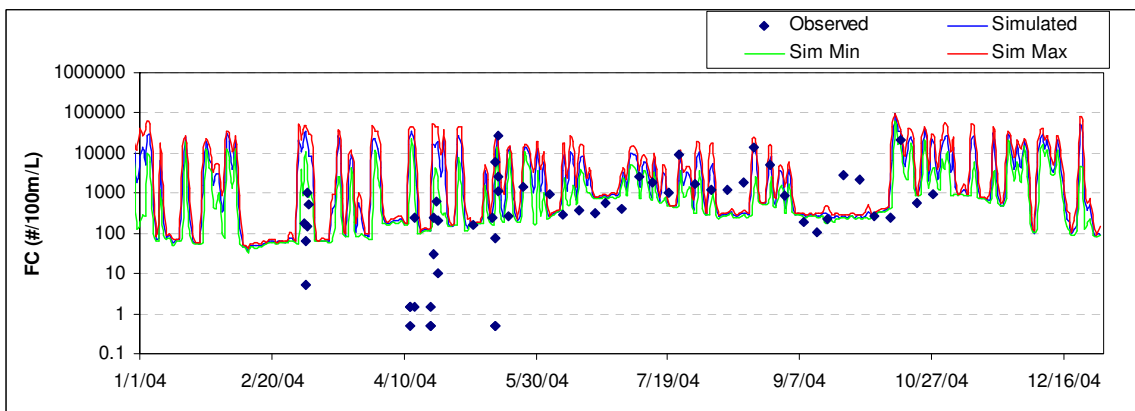
**Figure D.7 2001 Calibration Plot for Fecal Coliform at Station ESFSF002**



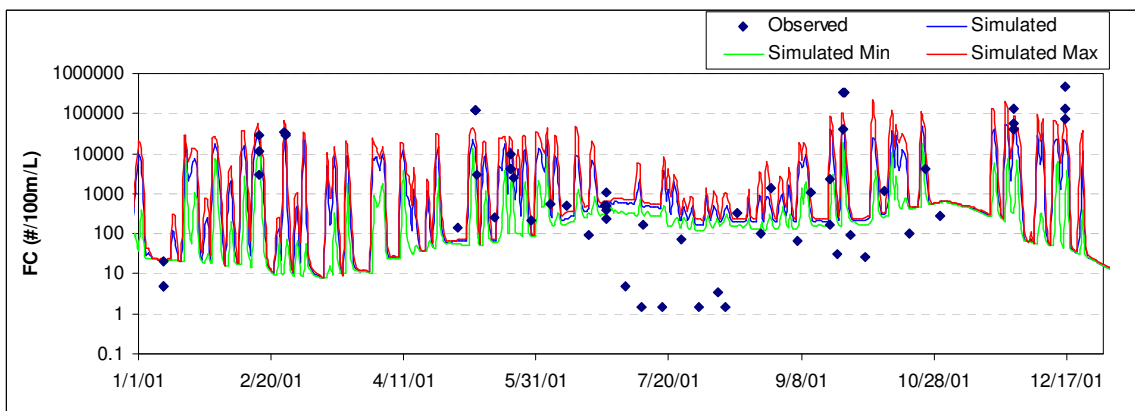
**Figure D.8 2004 Validation Plot for Fecal Coliform at Station ESFSF002**



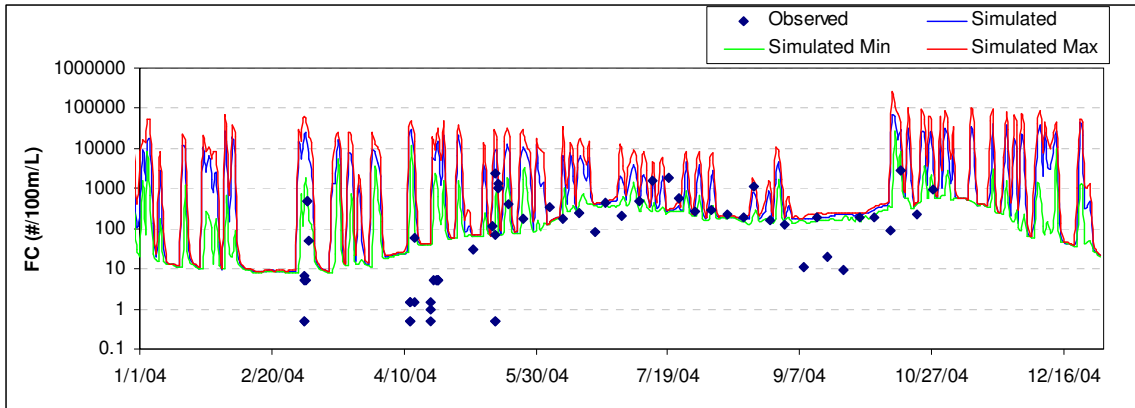
**Figure D.9 2001 Calibration Plot for Fecal Coliform at Station ESFSF006**



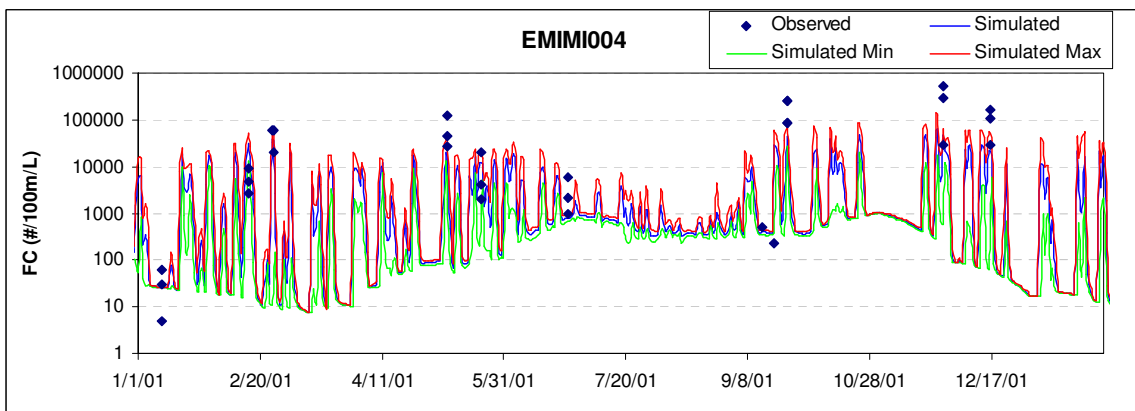
**Figure D.10 2004 Validation Plot for Fecal Coliform at Station ESFSF006**



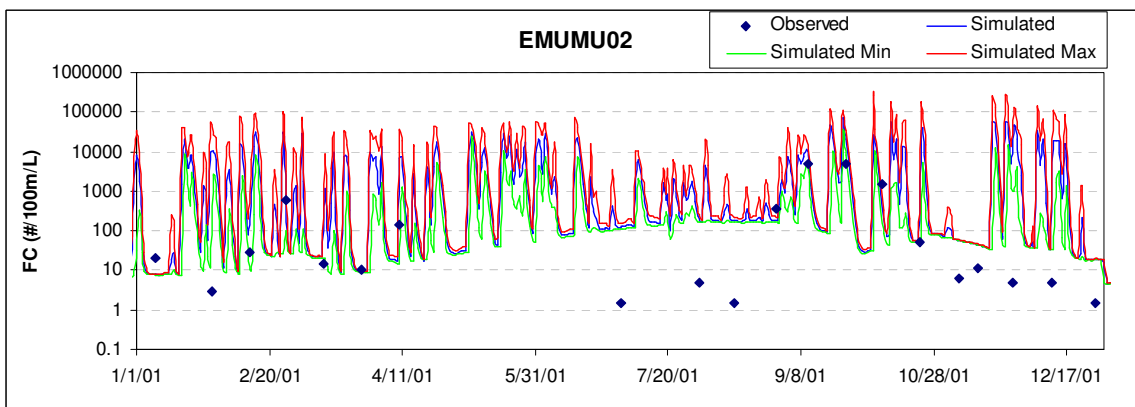
**Figure D.11 2001 Calibration Plot for Fecal Coliform at Station EMIMI002**



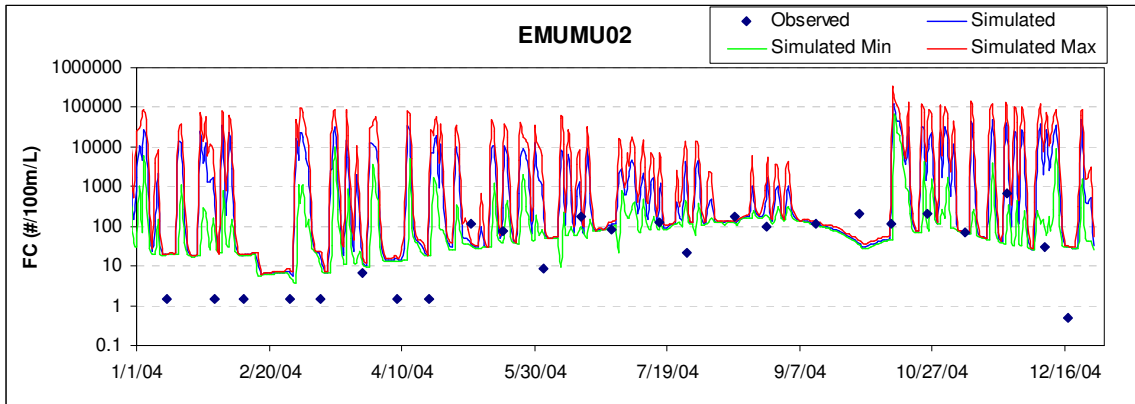
**Figure D.12 2004 Validation Plot for Fecal Coliform at Station EMIMI002**



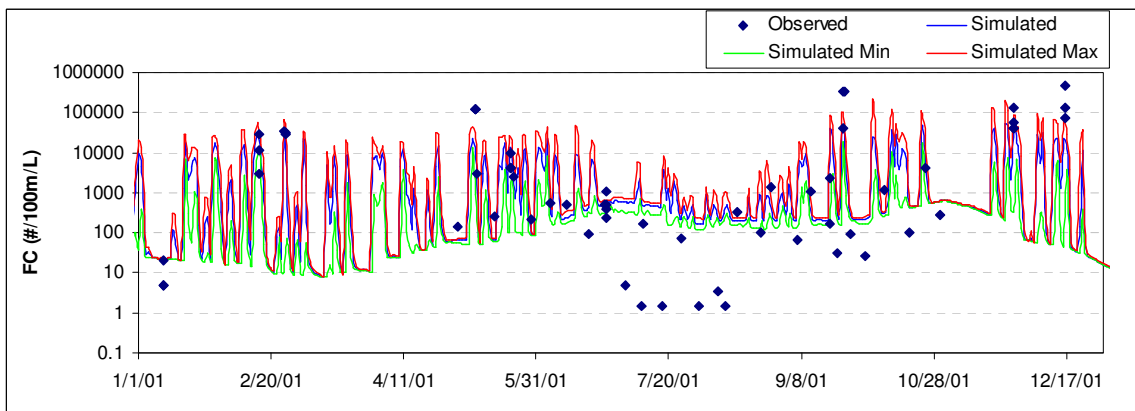
**Figure D.13 2001 Calibration Plot for Fecal Coliform at Station EMIMI004**



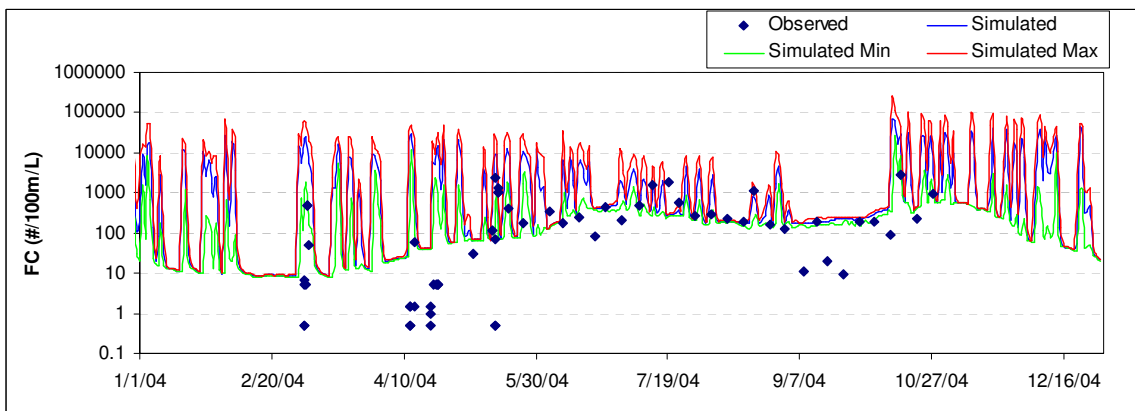
**Figure D.14 2001 Calibration Plot for Fecal Coliform at Station EMUMU002**



**Figure D.15 2004 Validation Plot for Fecal Coliform at Station EMUMU002**



**Figure D.16 2001 Calibration Plot for Fecal Coliform at Station EMUMU004**



**Figure D.17 2004 Validation Plot for Fecal Coliform at Station EMUMU004**



**APPENDIX E: EXCURSION FREQUENCIES  
BASELINE SCENARIO**

**Table E.1 Baseline Scenario 2000 – 2004 Geomean Excursion Frequency (%)**

Sub-Watershed	Reporting Sub-basin	All Data	Season	
			Winter	Recreation
Muddy Fork	SMU004	40.6%	6.1%	74.7%
	SMU002	38.8%	5.2%	71.9%
	SMU000	58.9%	30.3%	87.0%
Middle Fork	SMI002	54.4%	18.2%	90.2%
	SMI004	58.2%	23.4%	92.5%
	SMI000	59.9%	26.1%	93.2%
South Fork	SSF001	34.5%	9.5%	59.2%
	SSF002	58.1%	24.4%	91.2%
	SSF000	67.2%	38.0%	96.0%
	SSF006	71.8%	45.1%	98.1%
Main Stem	SMS000	81.0%	62.1%	99.6%

**Table E.2 Baseline Scenario 2000 – 2004 Max Excursion Frequency (%)**

Sub-Watershed	Reporting Sub-basin	All Data	Season	
			Winter	Recreation
Muddy Fork	SMU004	28.3	24.1	32.5
	SMU002	26.5	22.1	30.8
	SMU000	46.4	31.3	61.3
Middle Fork	SMI002	34.5	23.0	45.9
	SMI004	44.1	24.8	63.1
	SMI000	42.7	26.9	58.3
South Fork	SSF001	25.7	23.1	28.1
	SSF002	40.6	24.9	56.1
	SSF000	48.0	27.3	68.5
	SSF006	55.6	33.1	77.8
Main Stem	SMS000	63.2	43.0	83.0

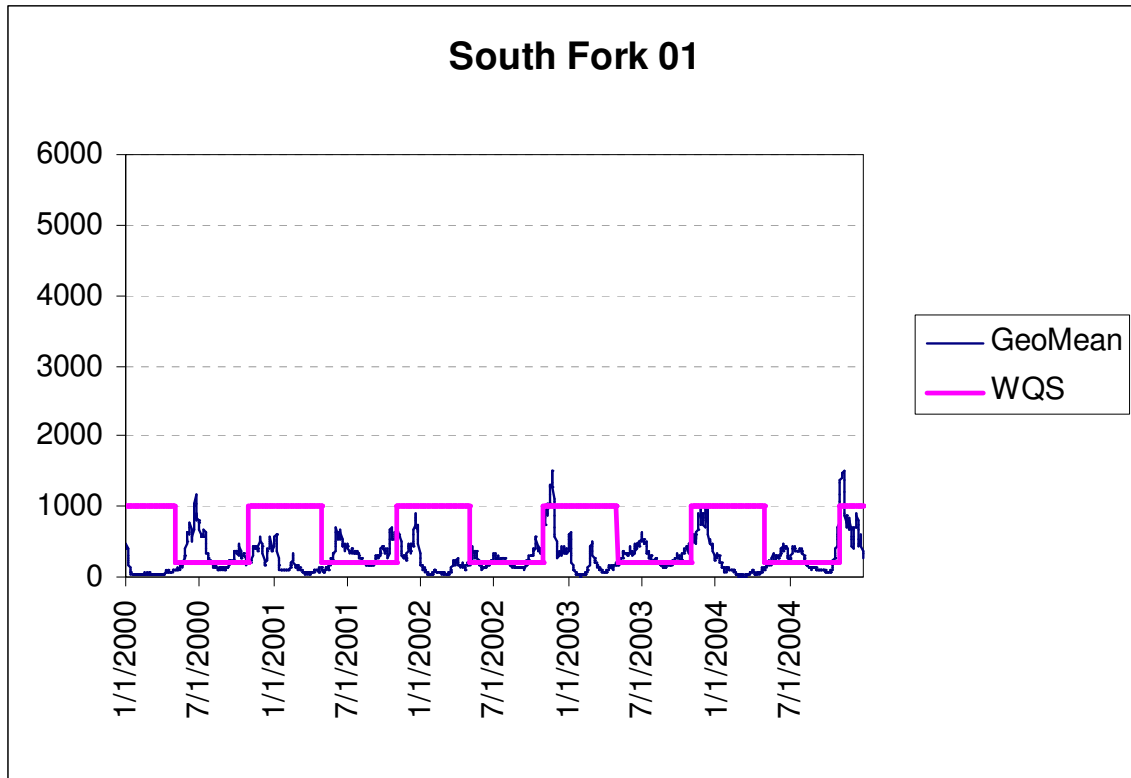


Figure E.1 Geomean vs. Water Quality Standard Reporting Sub-basin SSF001

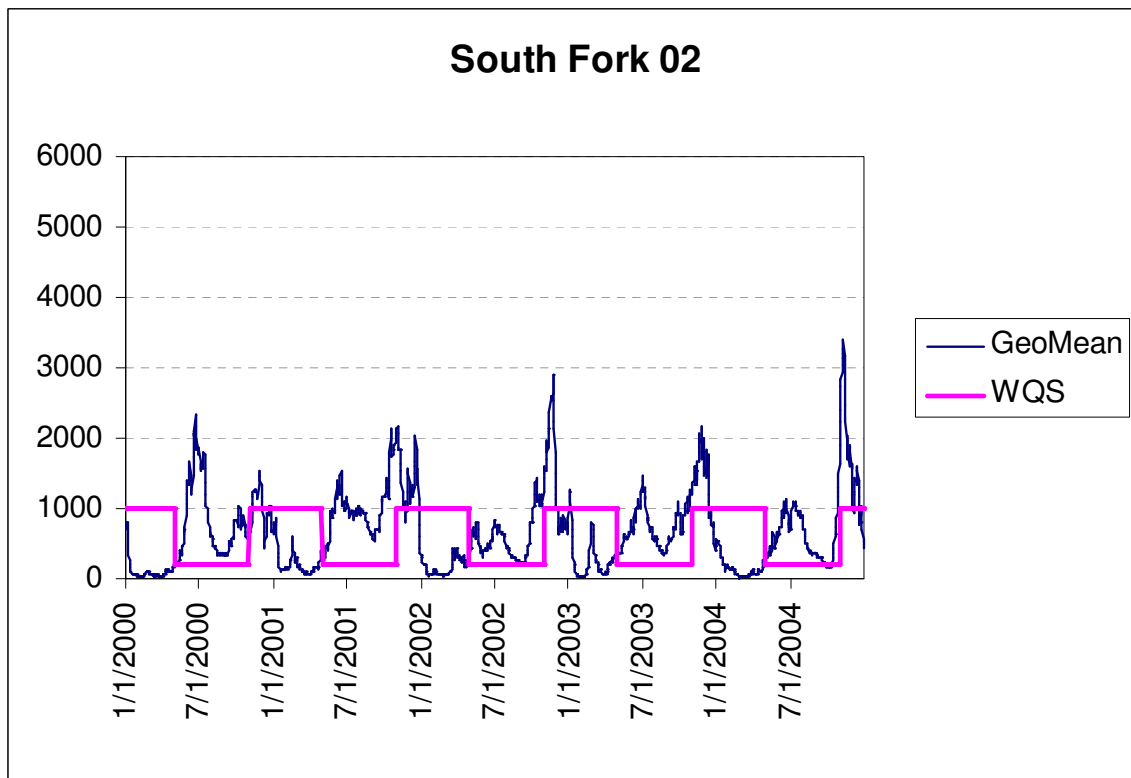


Figure E.2 Geomean vs. Water Quality Standard Reporting Sub-basin SSF002

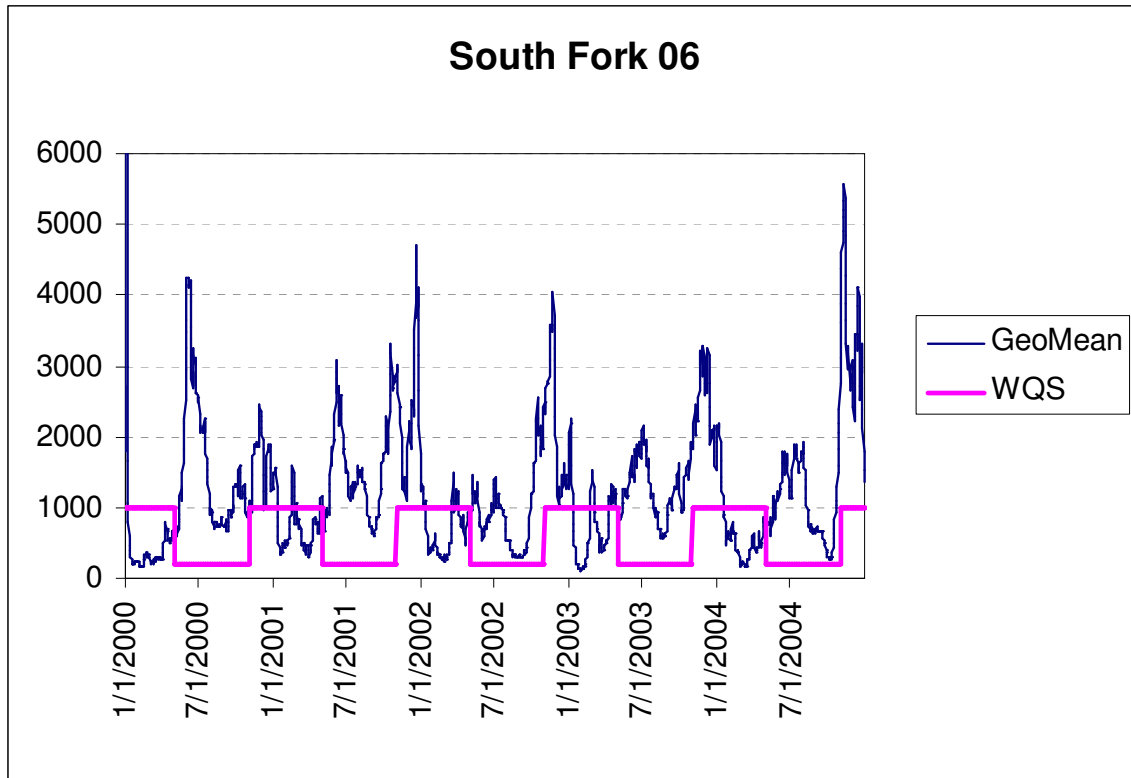


Figure E.3 Geomean vs. Water Quality Standard Reporting Sub-basin SSF006

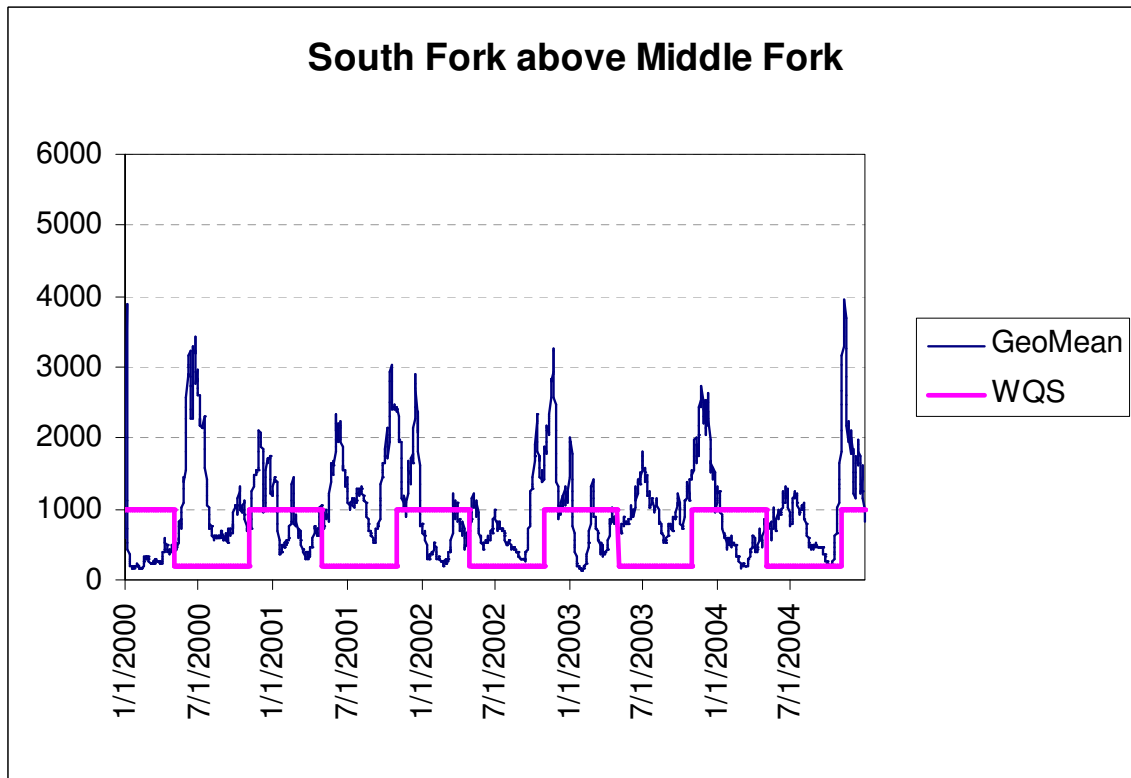


Figure E.4 Geomean vs. Water Quality Standard Reporting Sub-basin SSF000

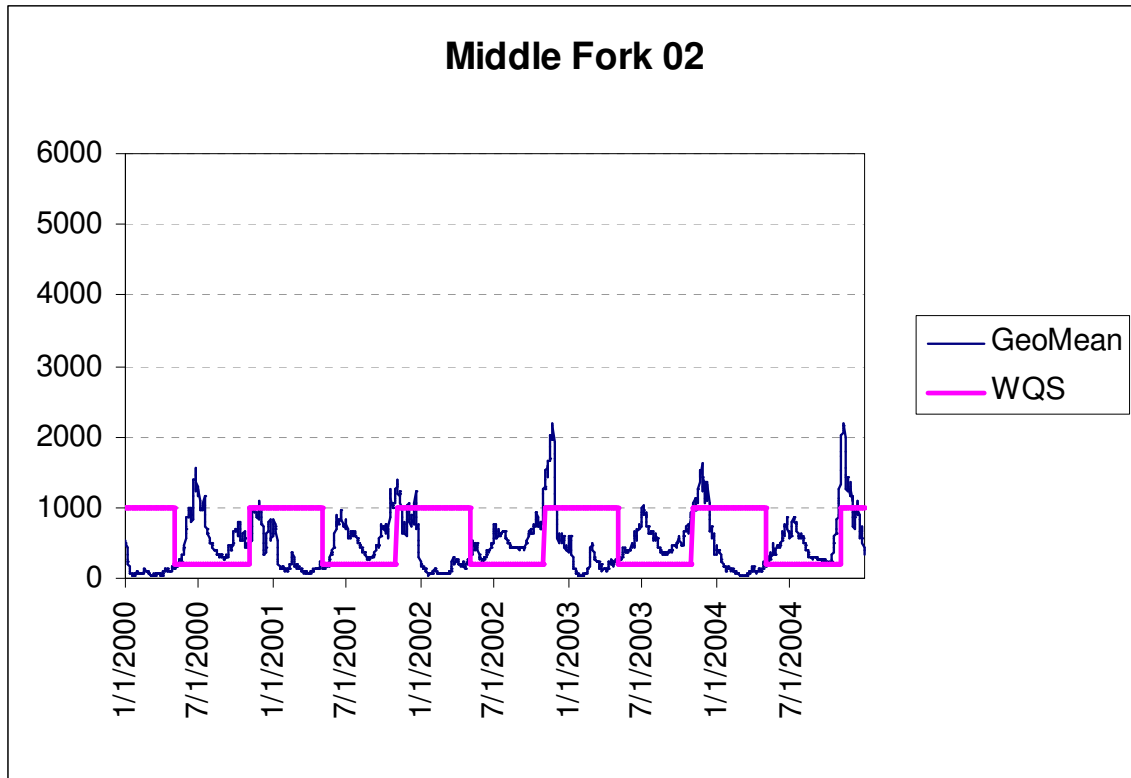


Figure E.5 Geomean vs. Water Quality Standard Reporting Sub-basin SMI002

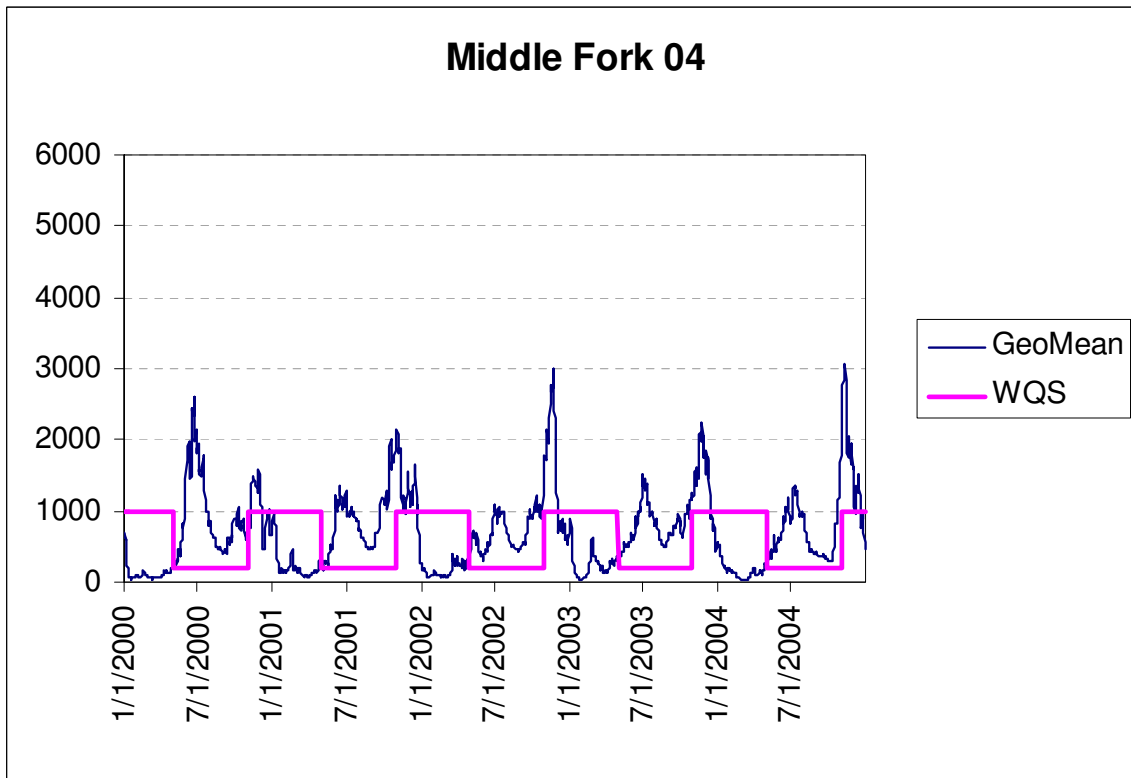


Figure E.6 Geomean vs. Water Quality Standard Reporting Sub-basin SMI004

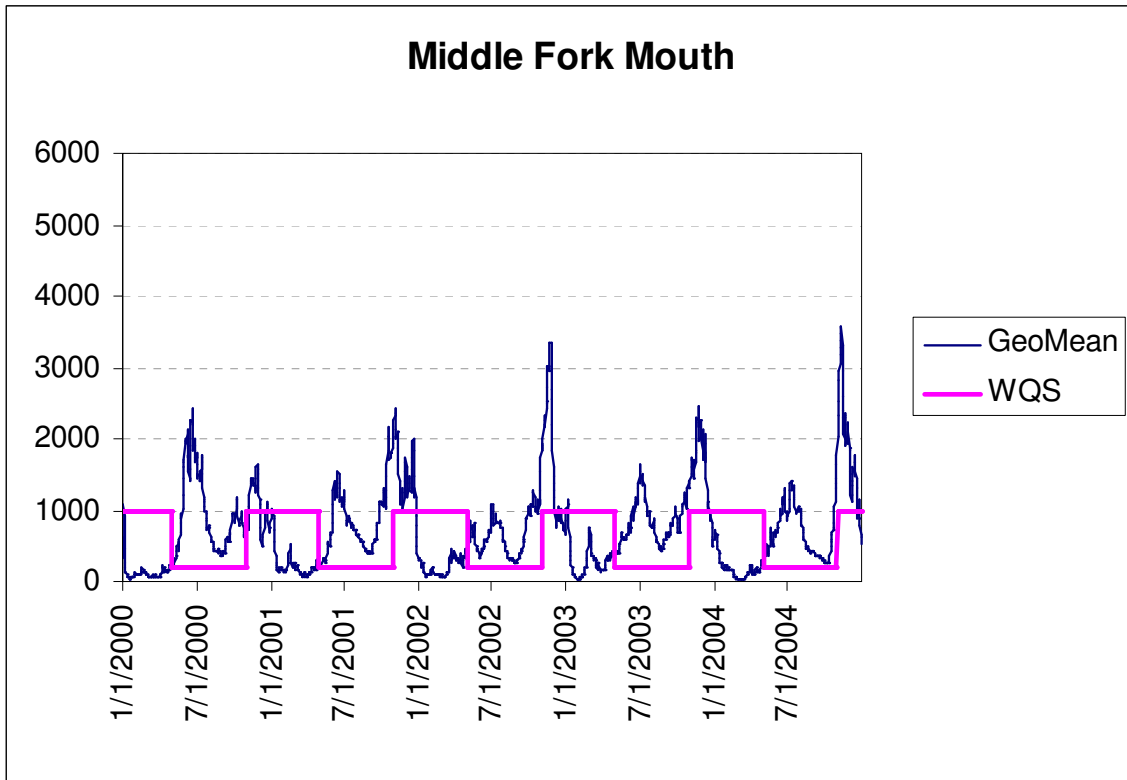


Figure E.7 Geomean vs. Water Quality Standard Reporting Sub-basin SMI000

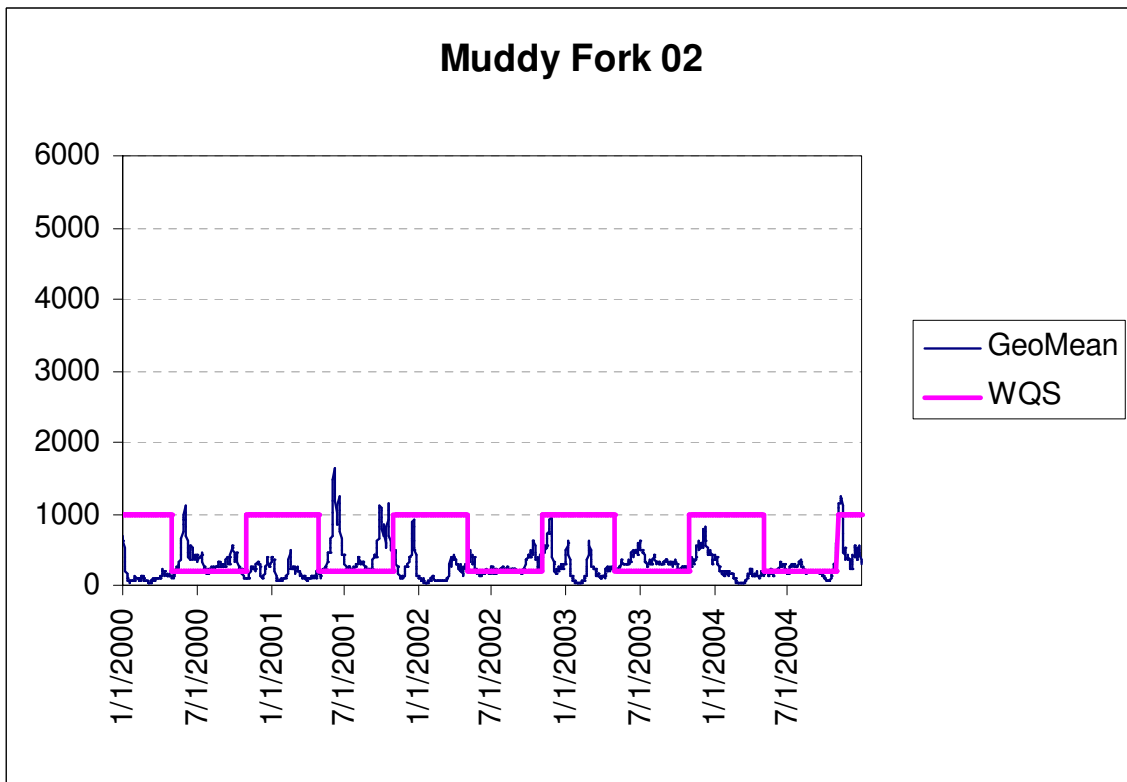


Figure E.8 Geomean vs. Water Quality Standard Reporting Sub-basin SMU002

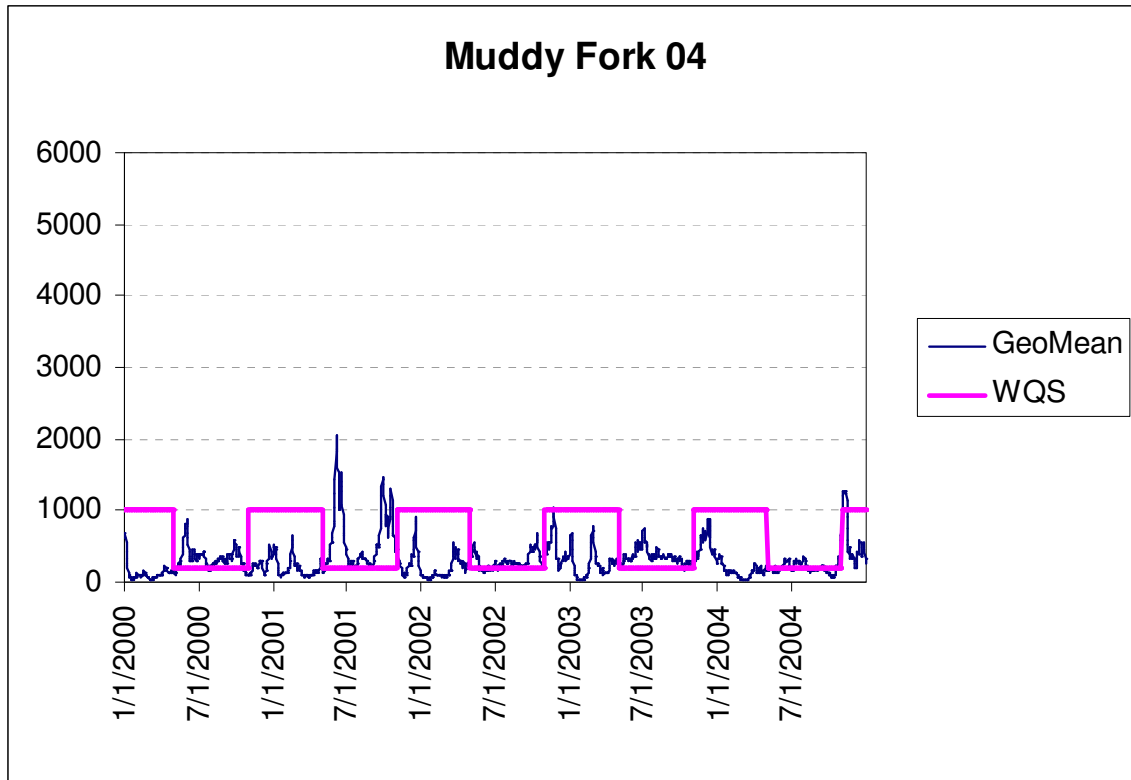


Figure E.9 Geomean vs. Water Quality Standard Reporting Sub-basin SMU004

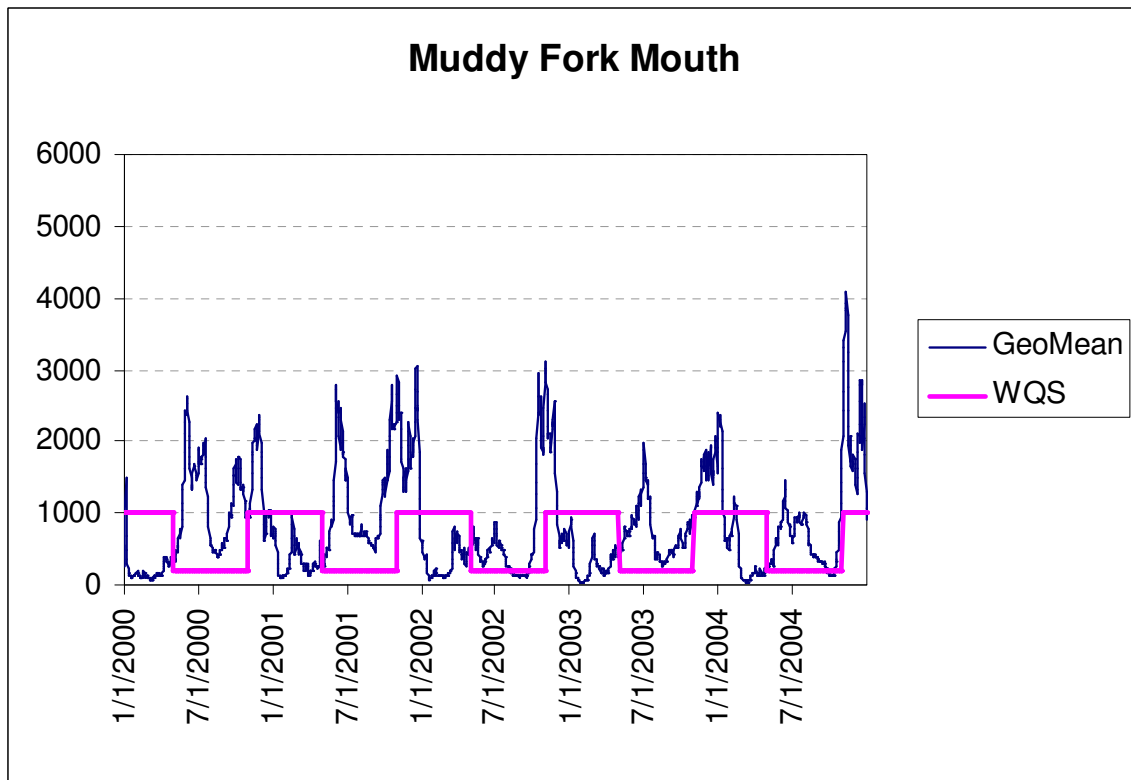


Figure E.10 Geomean vs. Water Quality Standard Reporting Sub-basin SMU000

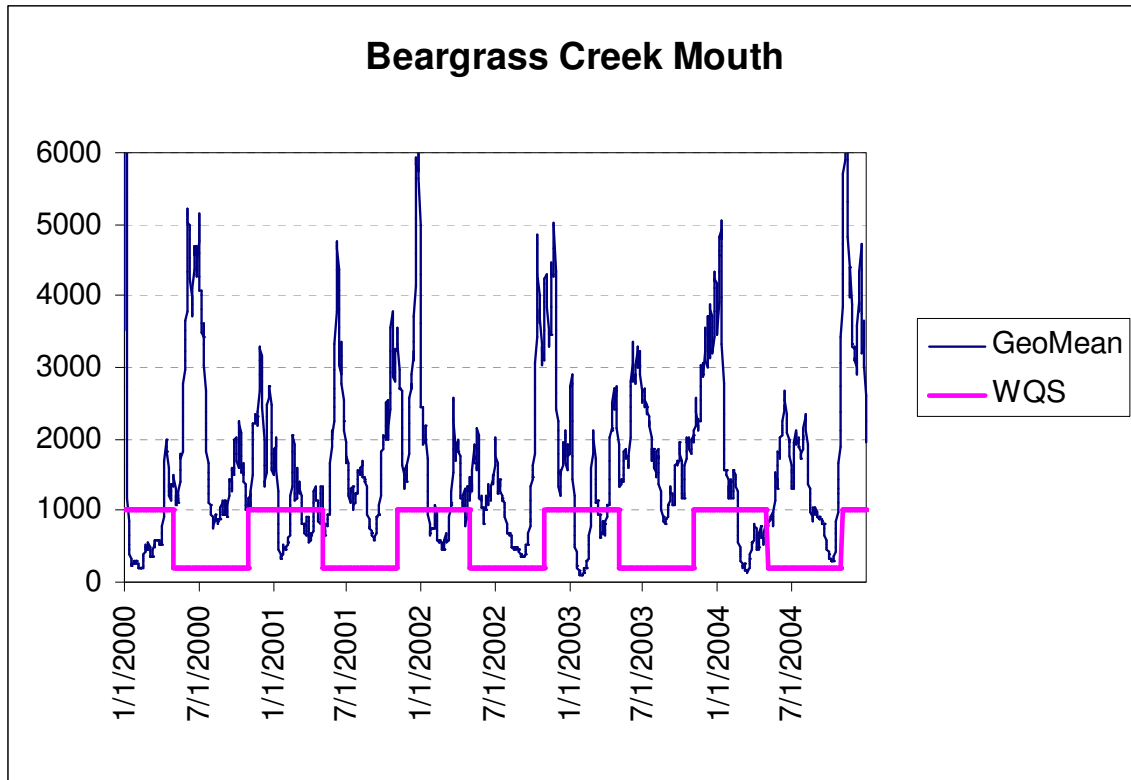


Figure E.11 Geomean vs. Water Quality Standard Reporting Sub-basin SMS000

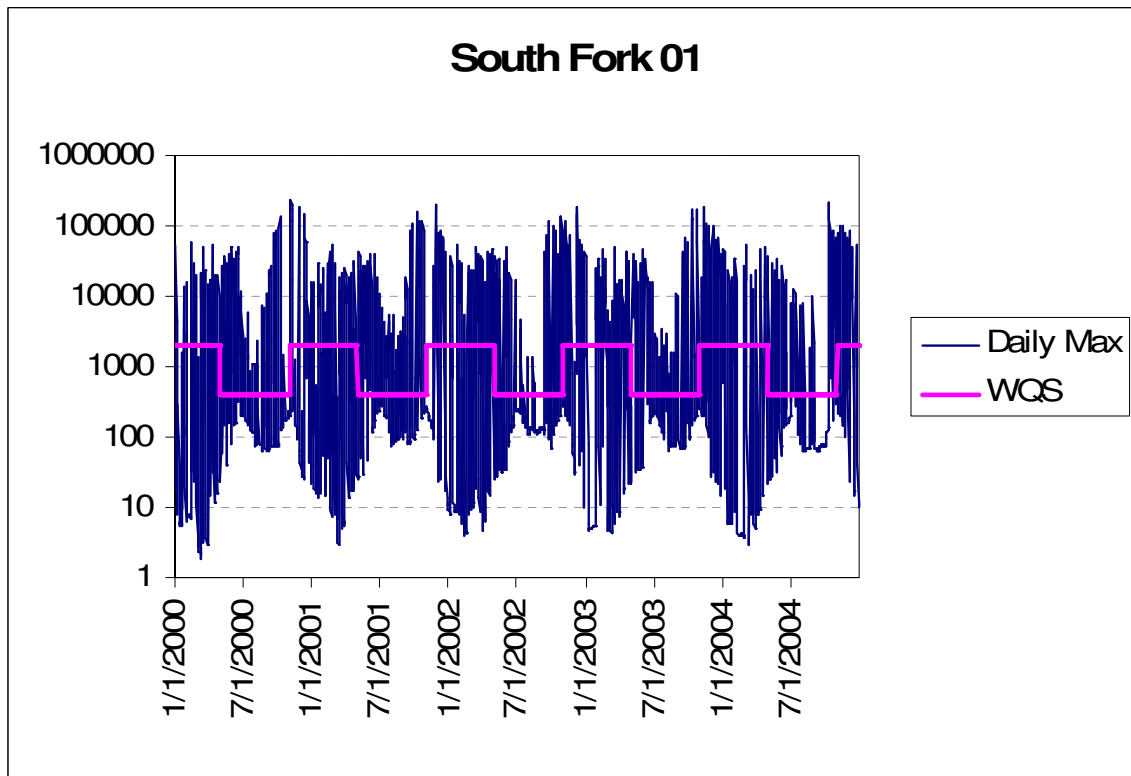


Figure E.12 Daily Max. vs. Water Quality Standard Reporting Sub-basin SSF001



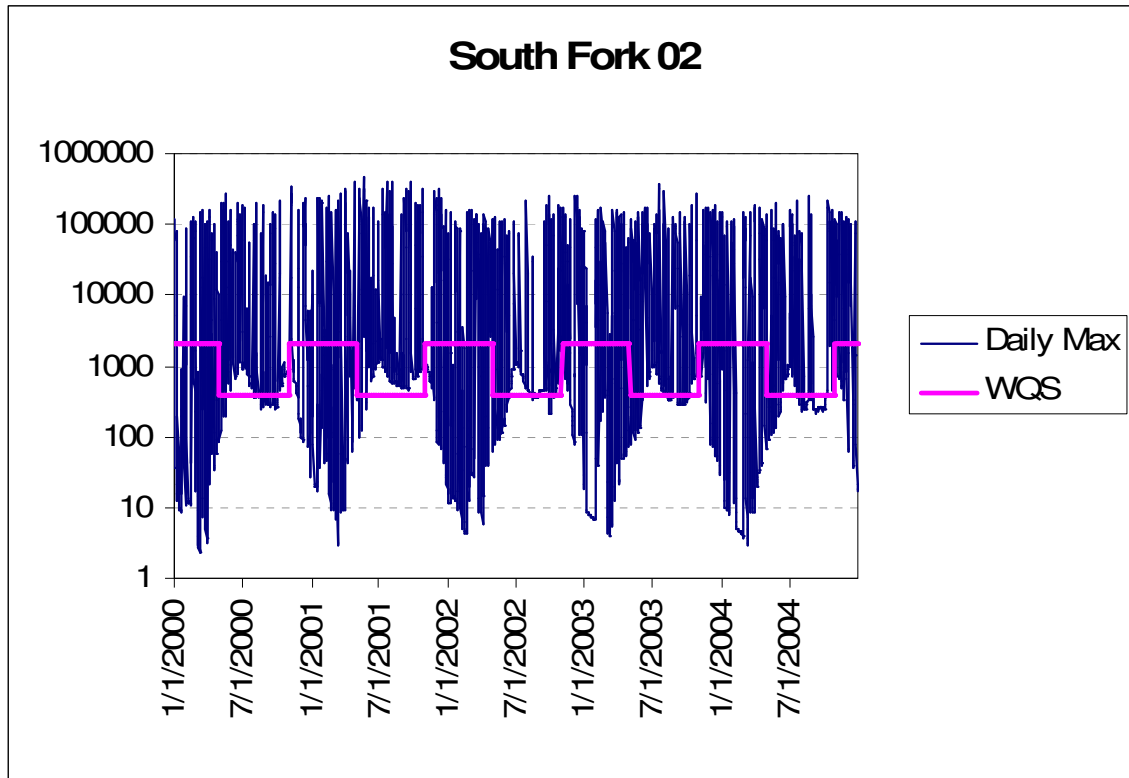


Figure E.13 Daily Max. vs. Water Quality Standard Reporting Sub-basin SSF002

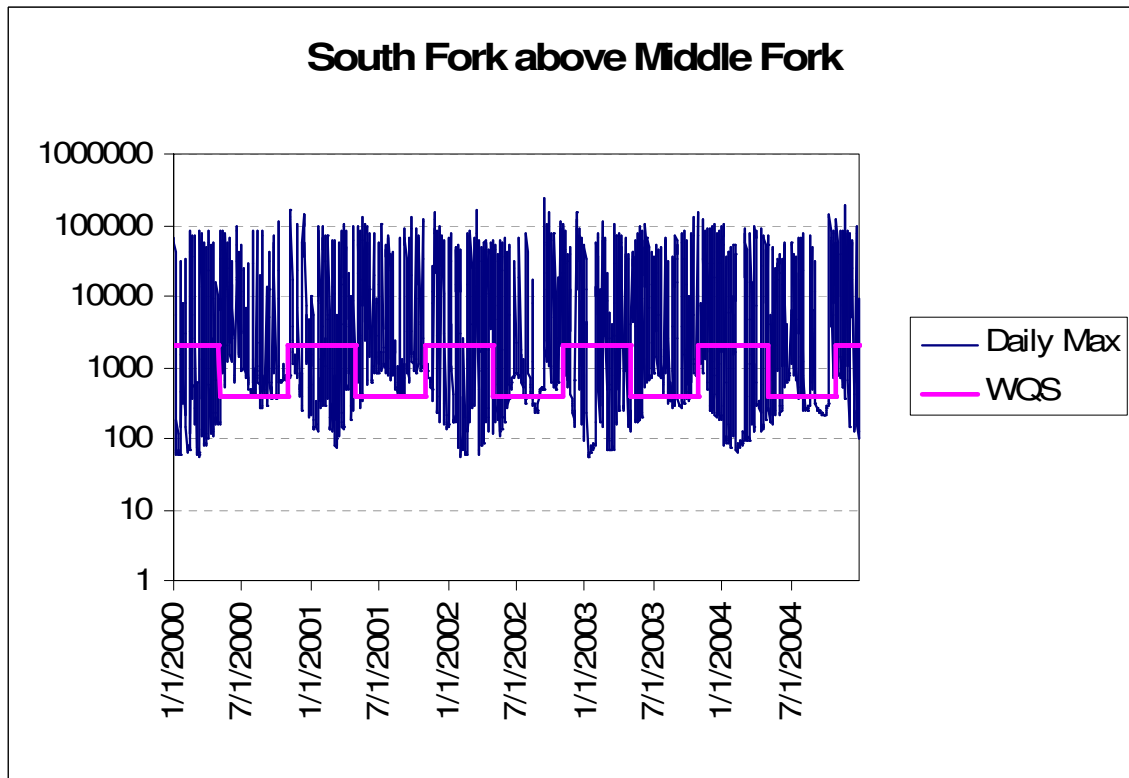


Figure E.14 Daily Max. vs. Water Quality Standard Reporting Sub-basin SSF000

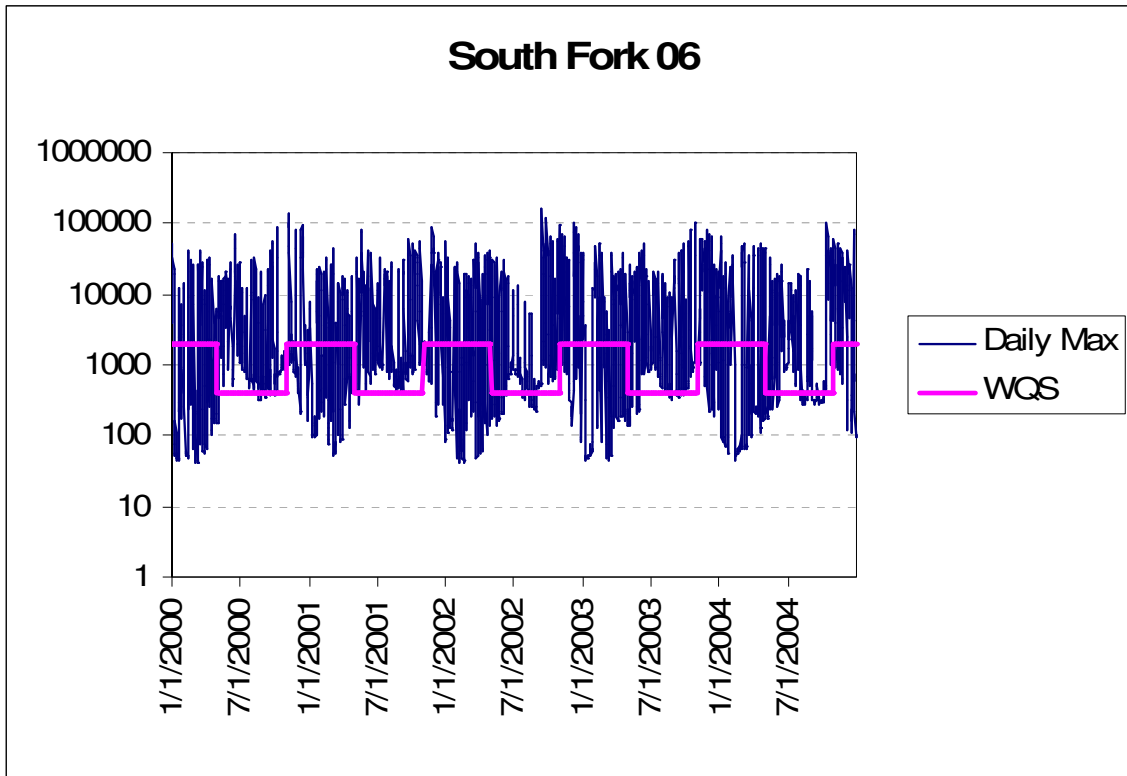


Figure E.15 Daily Max. vs. Water Quality Standard Reporting Sub-basin SSF006

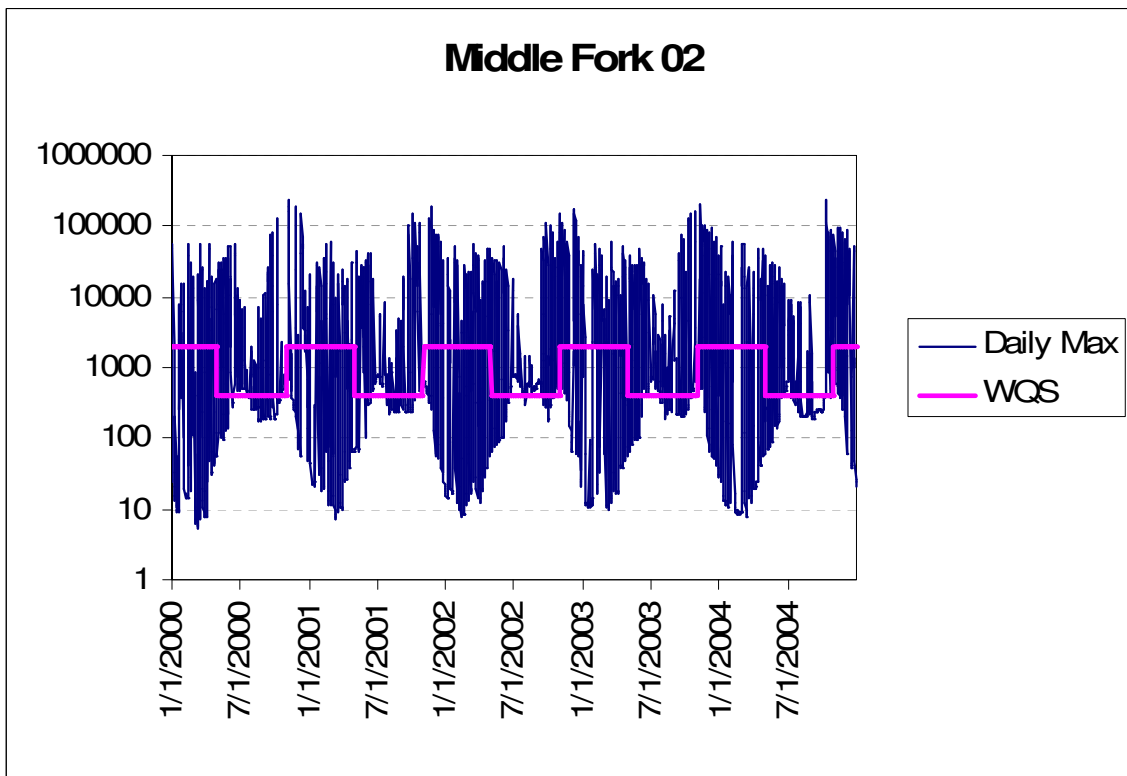


Figure E.16 Daily Max. vs. Water Quality Standard Reporting Sub-basin SMI002

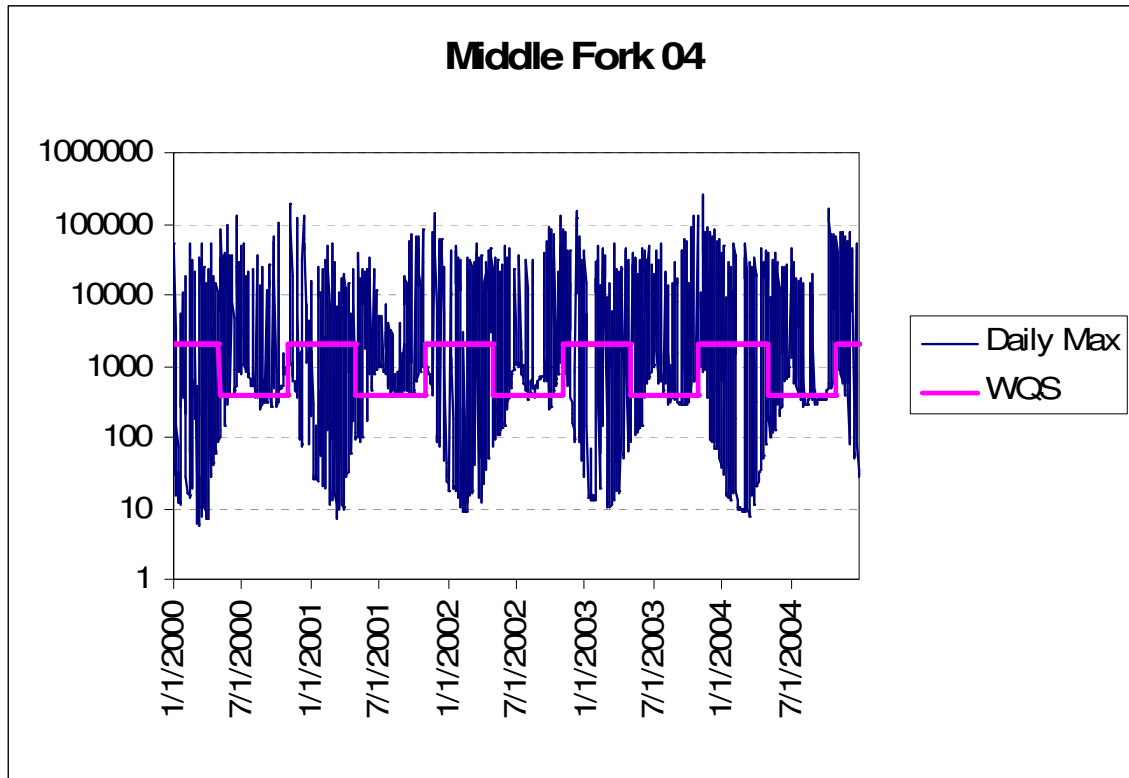


Figure E.17 Daily Max. vs. Water Quality Standard Reporting Sub-basin SMI004

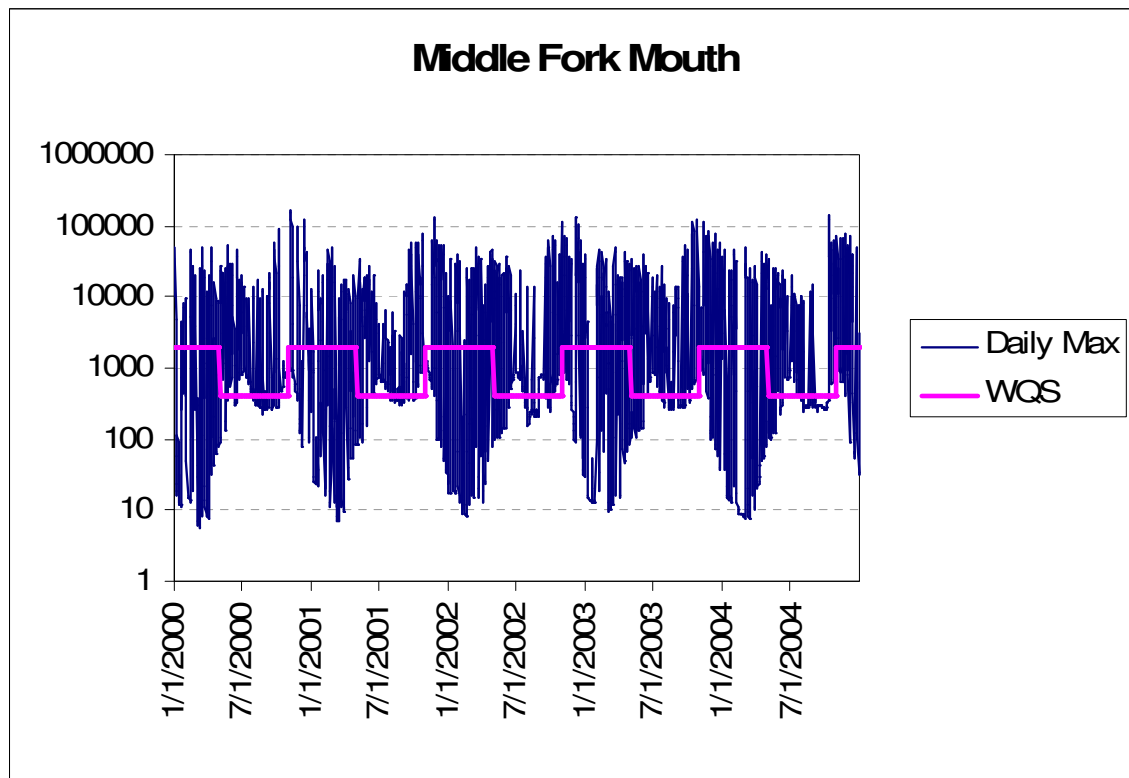


Figure E.18 Daily Max. vs. Water Quality Standard Reporting Sub-basin SMI000

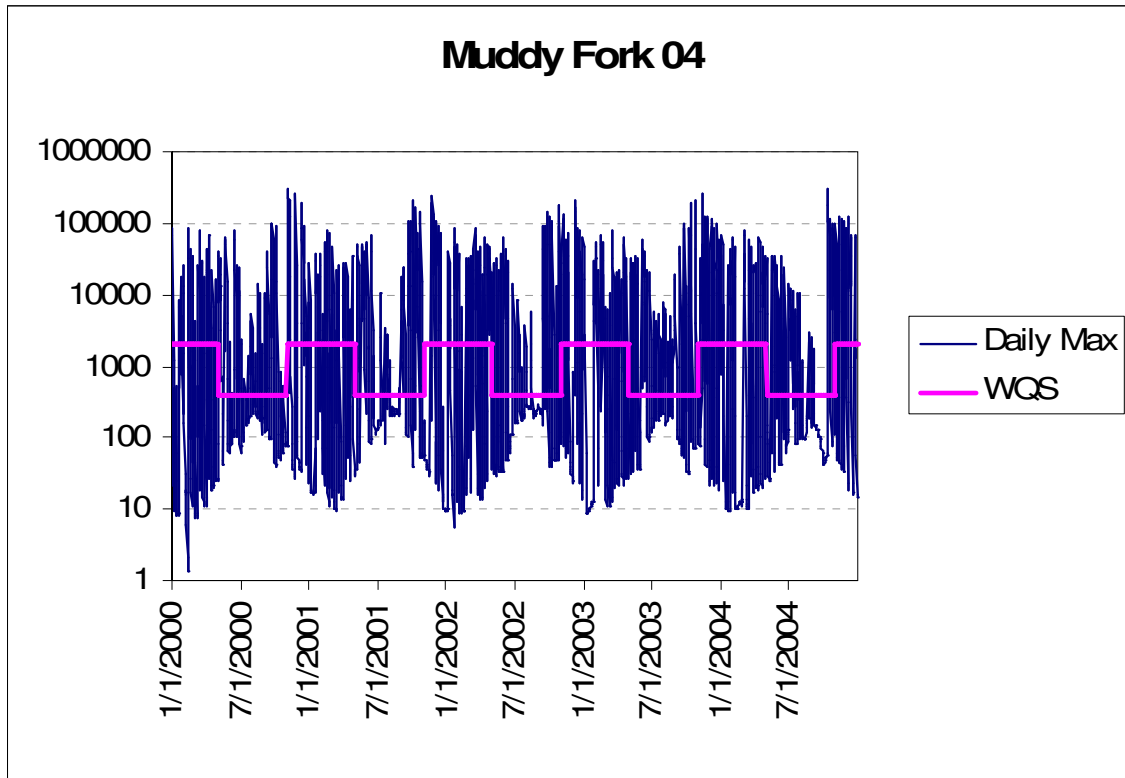


Figure E.19 Daily Max. vs. Water Quality Standard Reporting Sub-basin SMU004

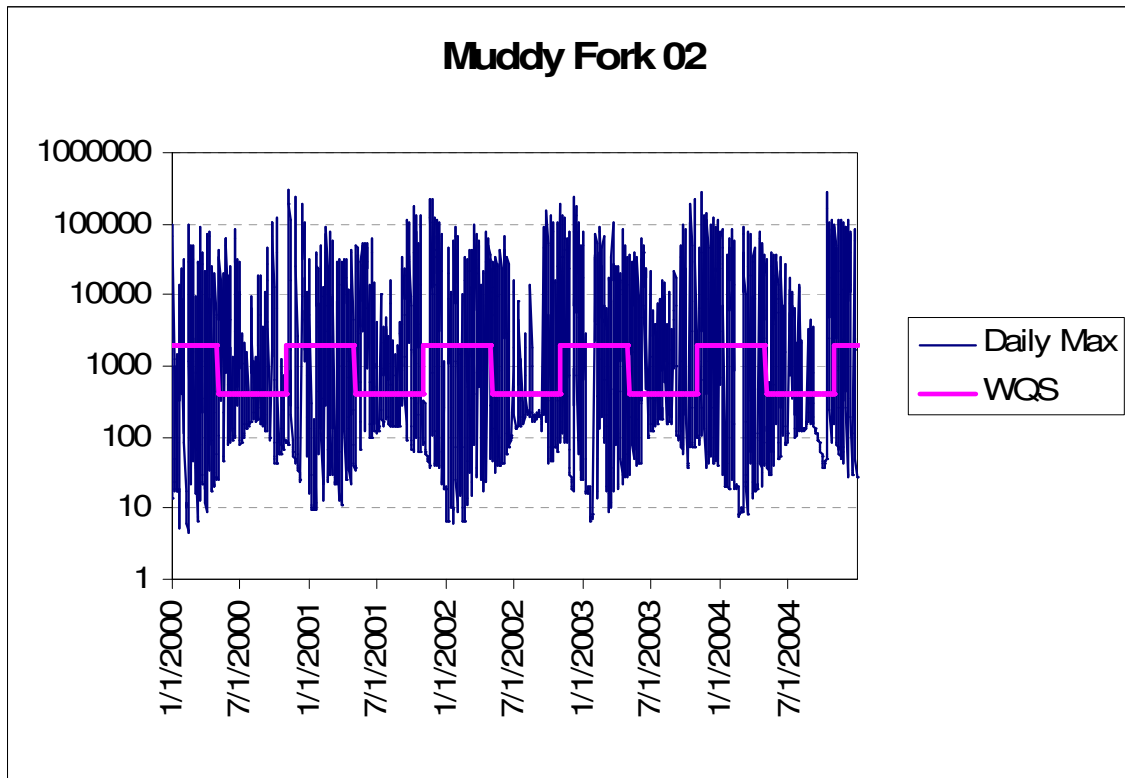


Figure E.20 Daily Max. vs. Water Quality Standard Reporting Sub-basin SMU002

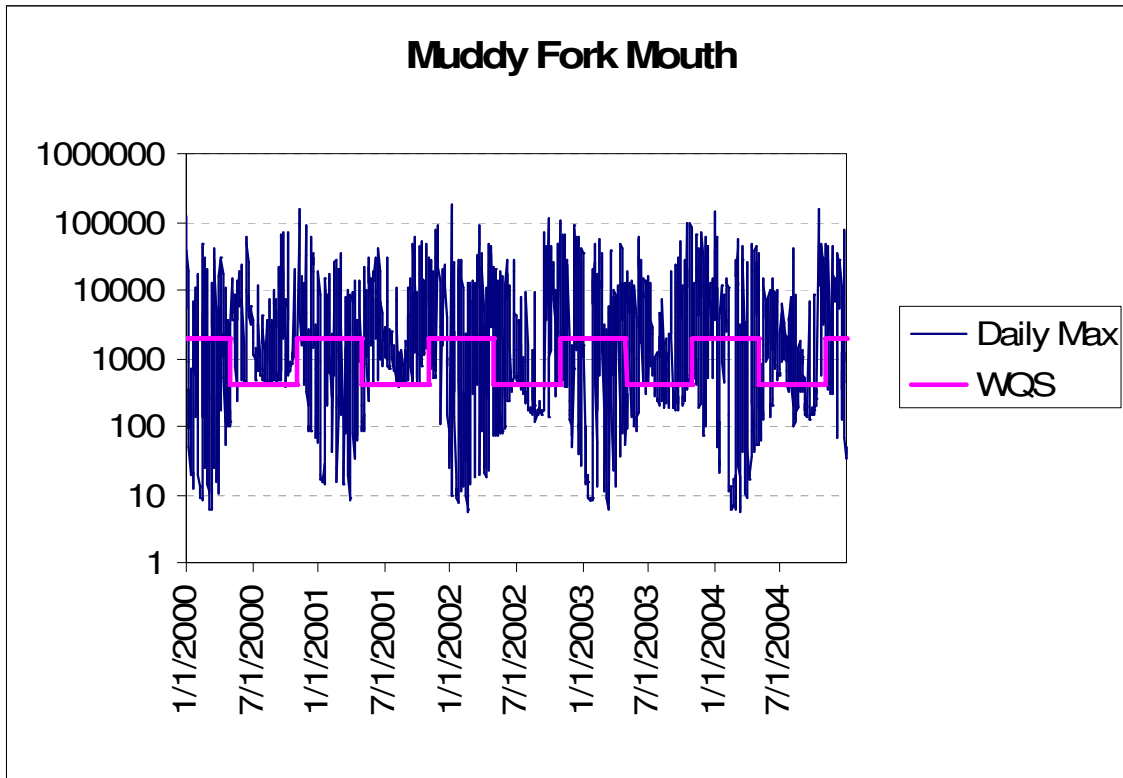


Figure E.21 Daily Max. vs. Water Quality Standard Reporting Sub-basin SMU000

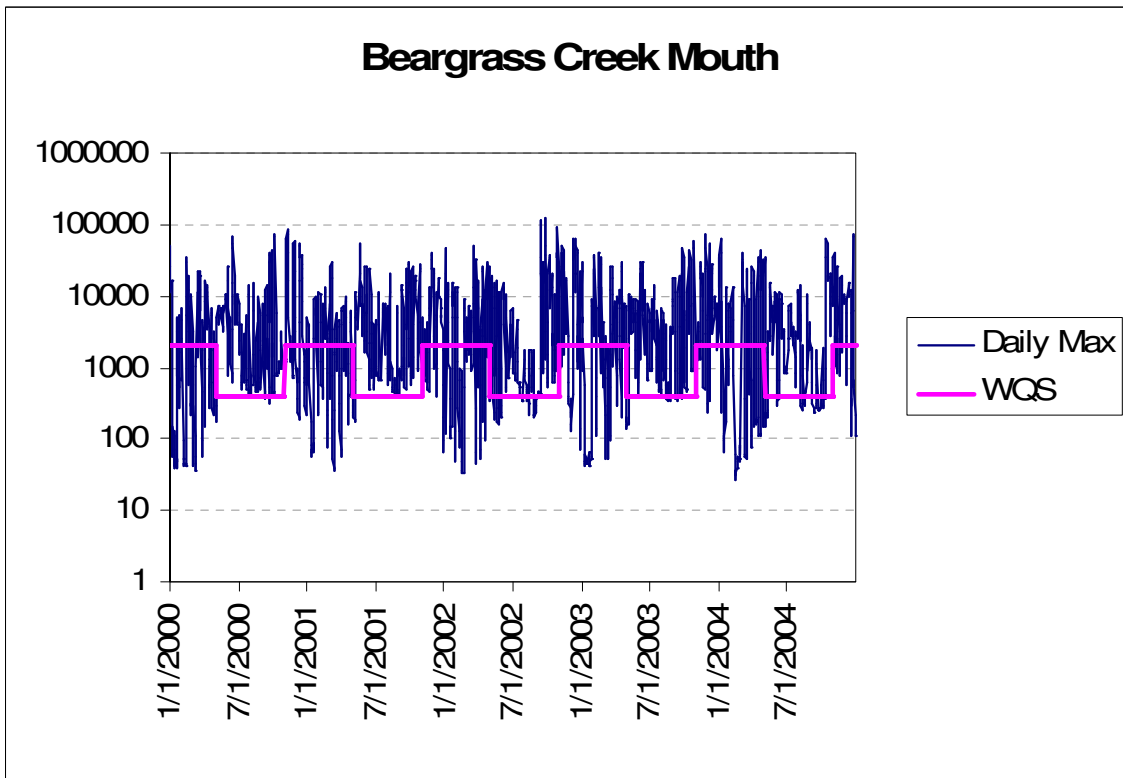


Figure E.22 Daily Max. vs. Water Quality Standard Reporting Sub-basin SMS000

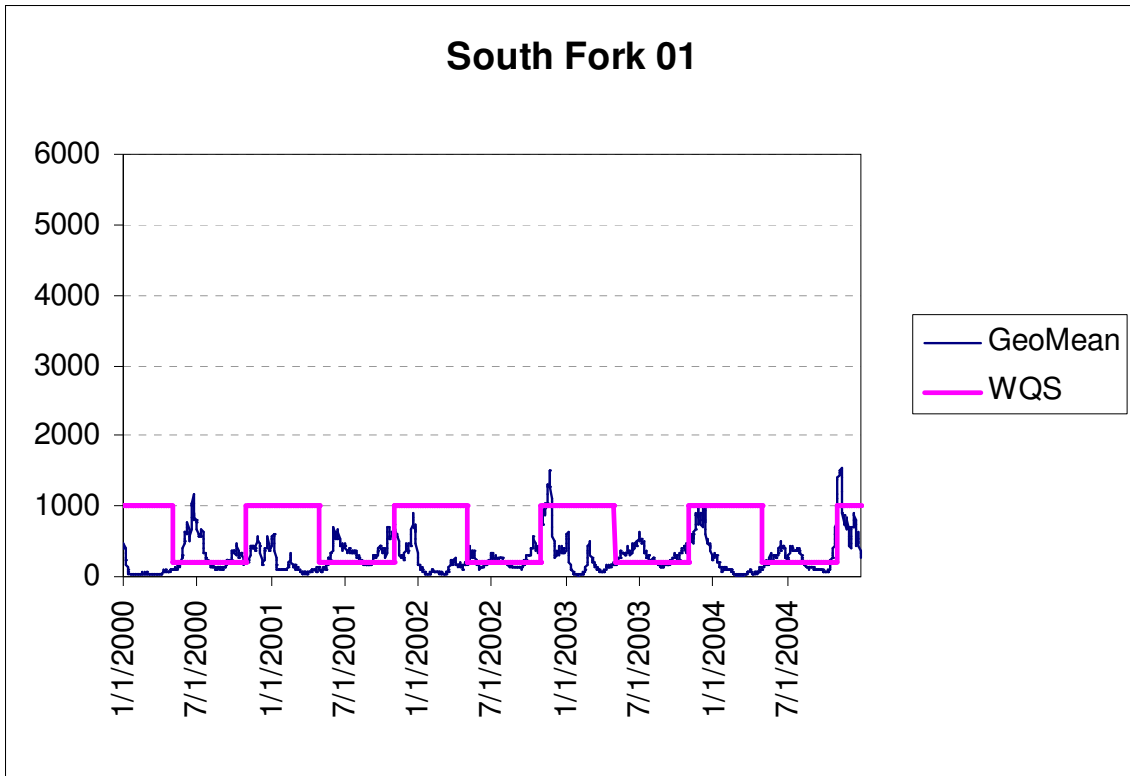
**APPENDIX F: EXCURSION FREQUENCIES  
NO CSO/SSO SCENARIO**

**Table F.1 2000 – 2004 Geomean Excursion Frequency (%)**

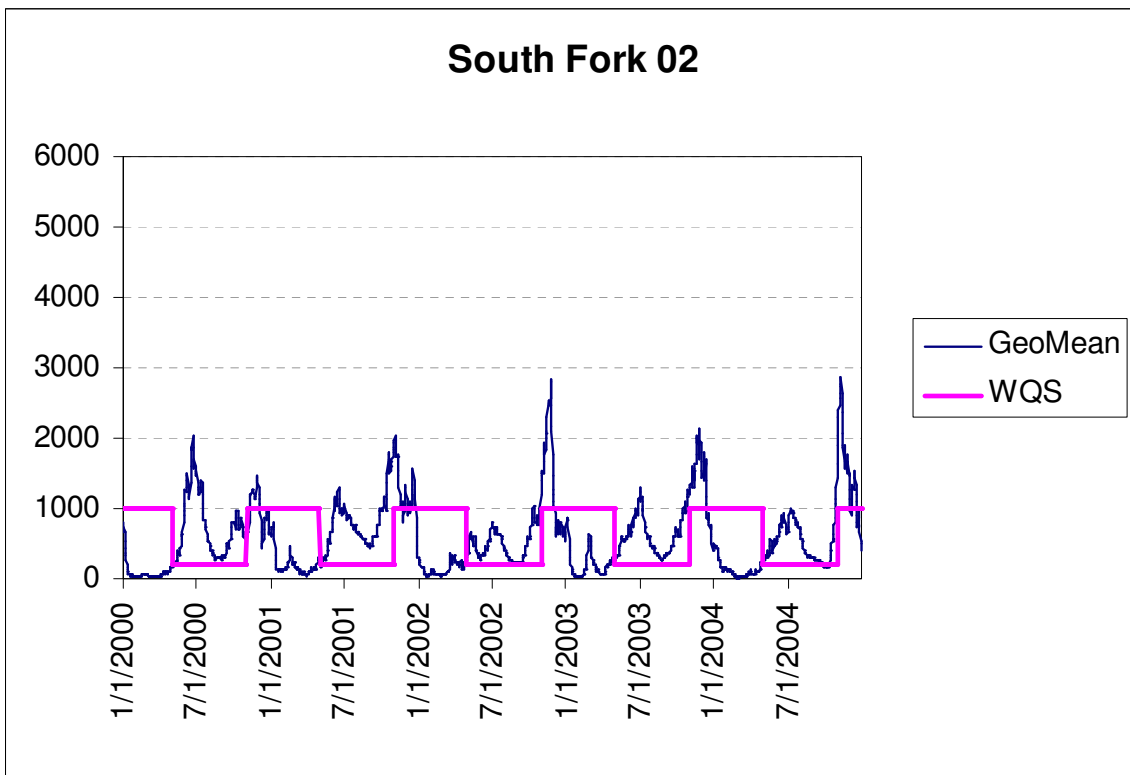
Sub-Watershed	Reporting Sub-basin	All	Season	
		Data	Winter	Recreation
Muddy Fork	SMU004	40.6%	6.1%	74.7%
	SMU002	38.8%	5.2%	71.9%
	SMU000	57.8%	26.3%	88.8%
Middle Fork	SMI002	54.4%	18.2%	90.2%
	SMI004	57.9%	23.2%	92.1%
	SMI000	59.2%	25.0%	93.0%
South Fork	SSF001	34.6%	9.6%	59.3%
	SSF002	56.6%	22.4%	90.3%
	SSF000	64.2%	33.6%	94.4%
	SSF006	64.8%	35.2%	94.0%
Main Stem	SMS000	71.1%	45.4%	96.5%

**Table F.2 2000 – 2004 Max Excursion Frequency (%)**

Sub-Watershed	Reporting Sub-basin	All	Season	
		Data	Winter	Recreation
Muddy Fork	SMU004	28.4	24.1	32.5
	SMU002	26.5	22.1	30.9
	SMU000	42.1	29.3	54.7
Middle Fork	SMI002	34.6	23.0	46.0
	SMI004	43.8	24.4	63.0
	SMI000	42.6	26.3	58.8
South Fork	SSF001	25.7	23.2	28.2
	SSF002	39.2	24.0	54.2
	SSF000	43.2	25.8	60.3
	SSF006	48.8	28.9	68.3
Main Stem	SMS000	56.4	37.5	75.0

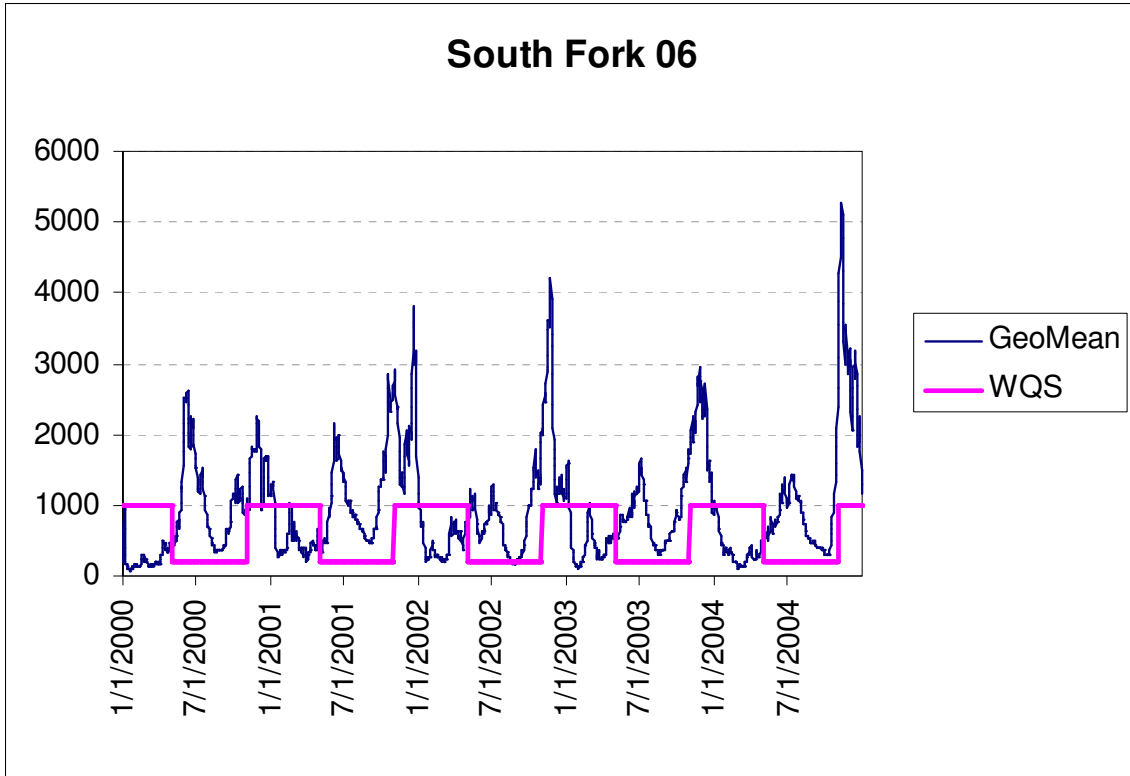


**Figure F.1 Geomean vs. Water Quality Standard Reporting Sub-basin SSF001**

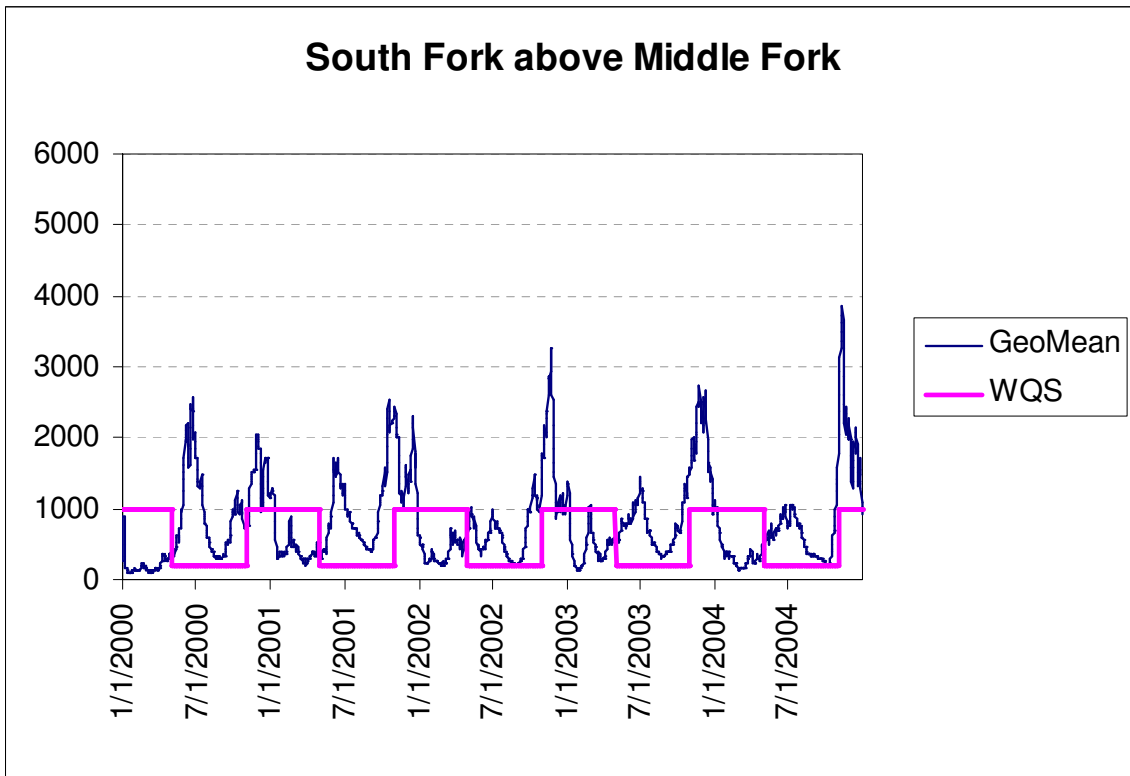


**Figure F.2 Geomean vs. Water Quality Standard Reporting Sub-basin SSF002**





**Figure F.3 Geomean vs. Water Quality Standard Reporting Sub-basin SSF006**



**Figure F.4 Geomean vs. Water Quality Standard Reporting Sub-basin SSF000**

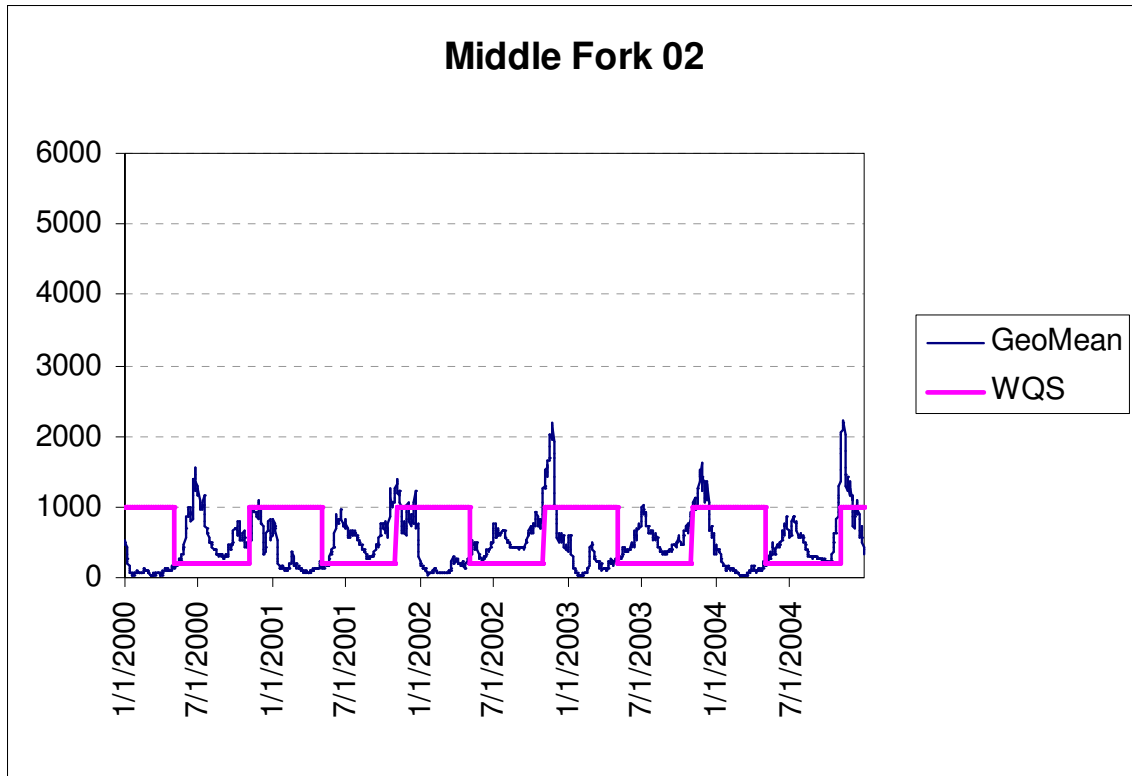


Figure F.5 Geomean vs. Water Quality Standard Reporting Sub-basin SMI002

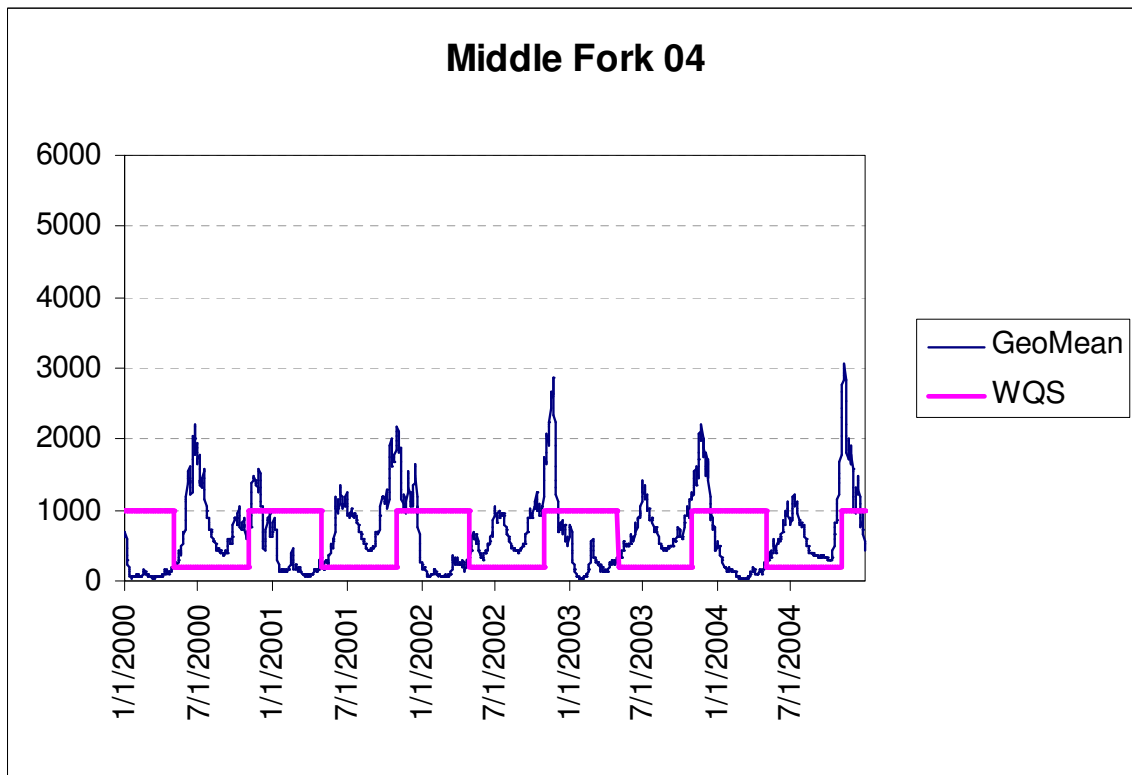


Figure F.6 Geomean vs. Water Quality Standard Reporting Sub-basin SMI004

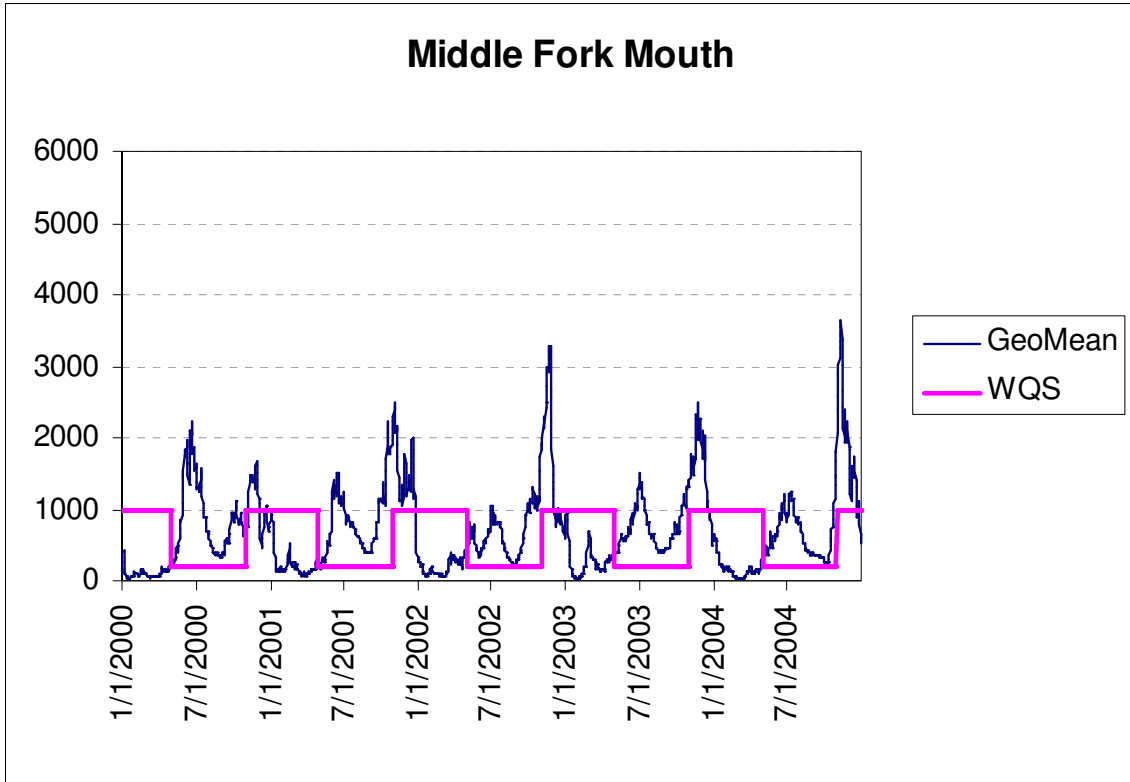


Figure F.7 Geomean vs. Water Quality Standard Reporting Sub-basin SMI000

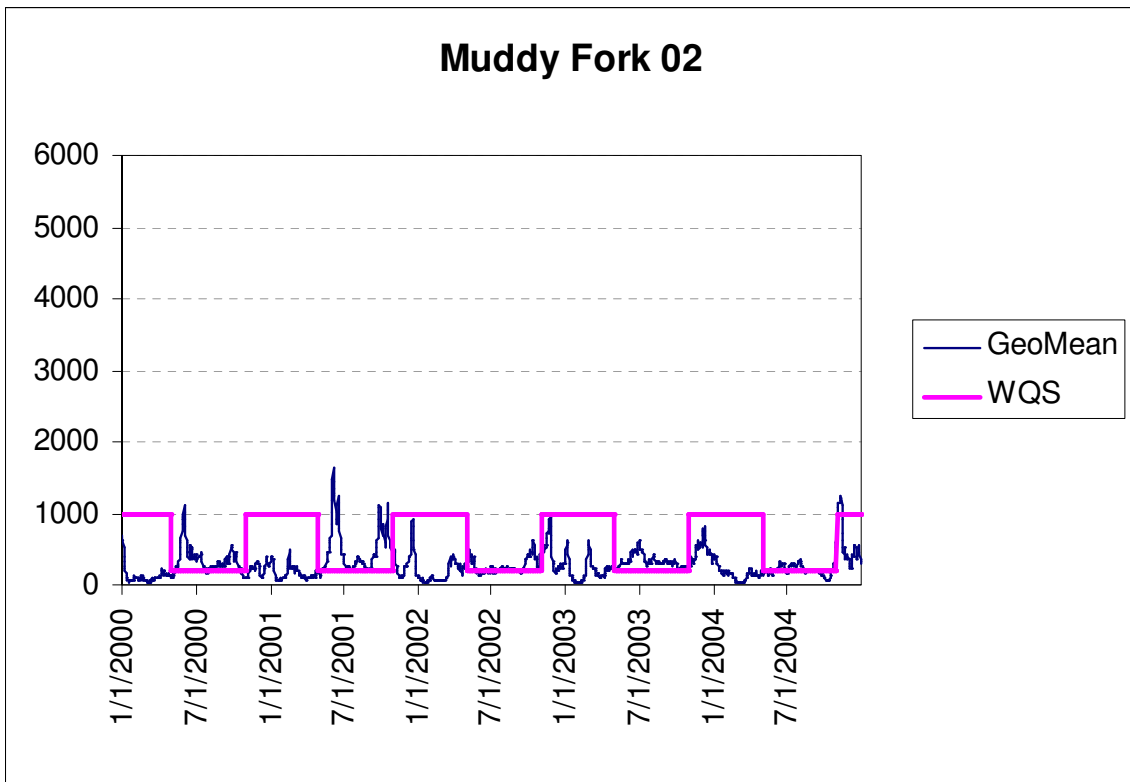


Figure F.8 Geomean vs. Water Quality Standard Reporting Sub-basin SMU002

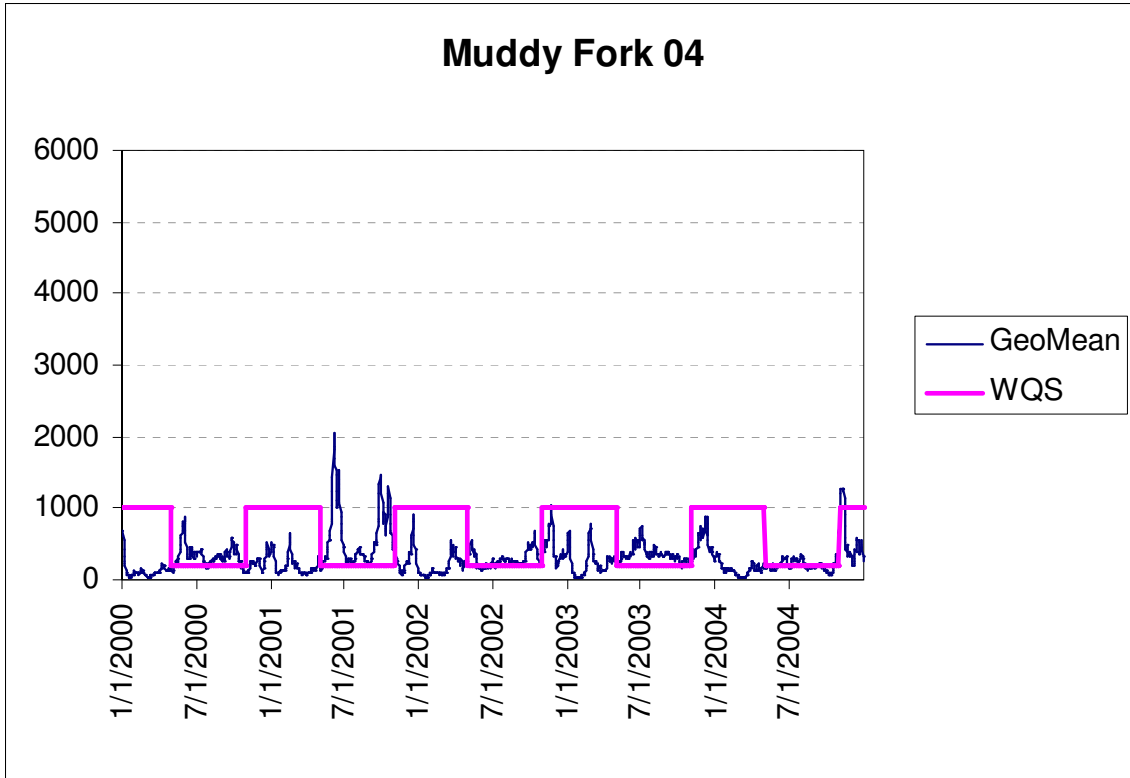


Figure F.9 Geomean vs. Water Quality Standard Reporting Sub-basin SMU004

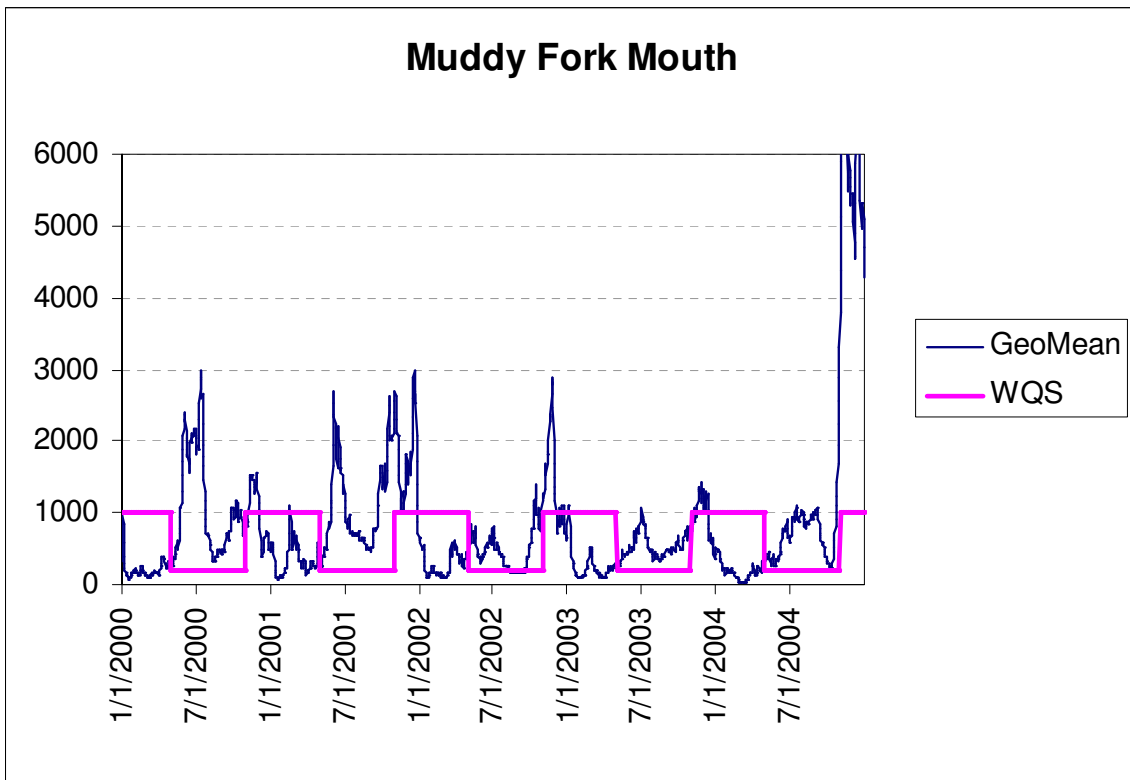


Figure F.10 Geomean vs. Water Quality Standard Reporting Sub-basin SMU000

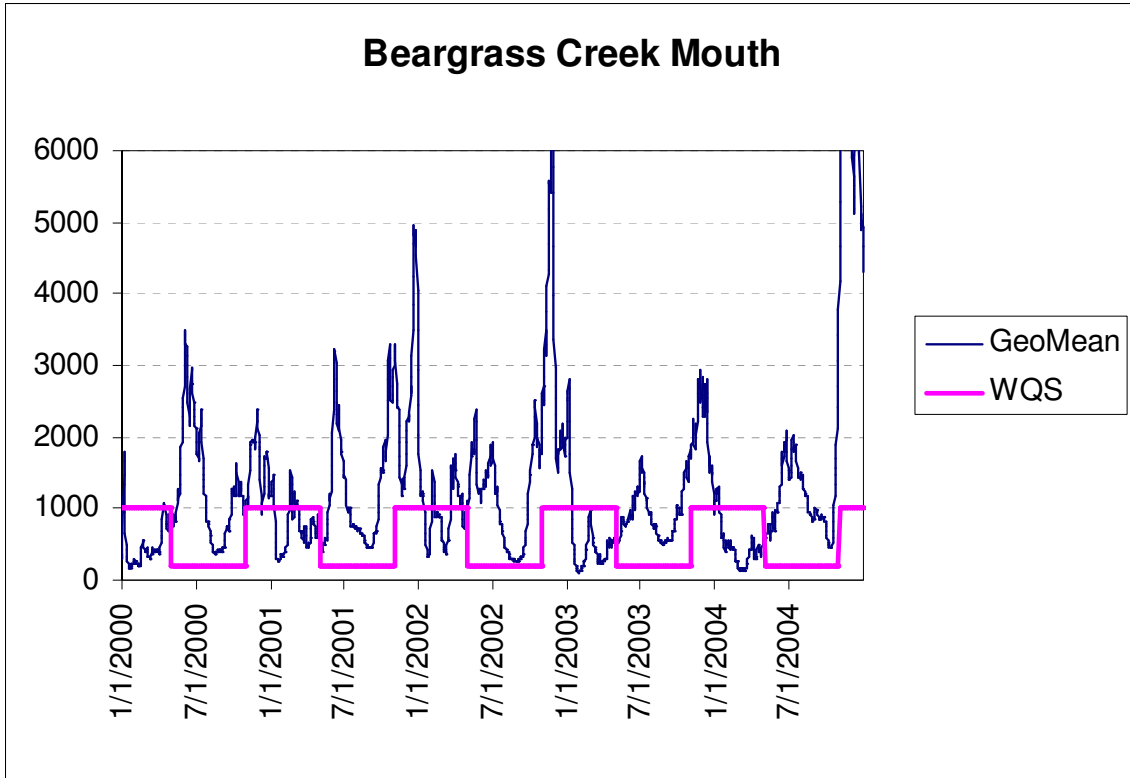


Figure F.11 Geomean vs. Water Quality Standard Reporting Sub-basin SMS000

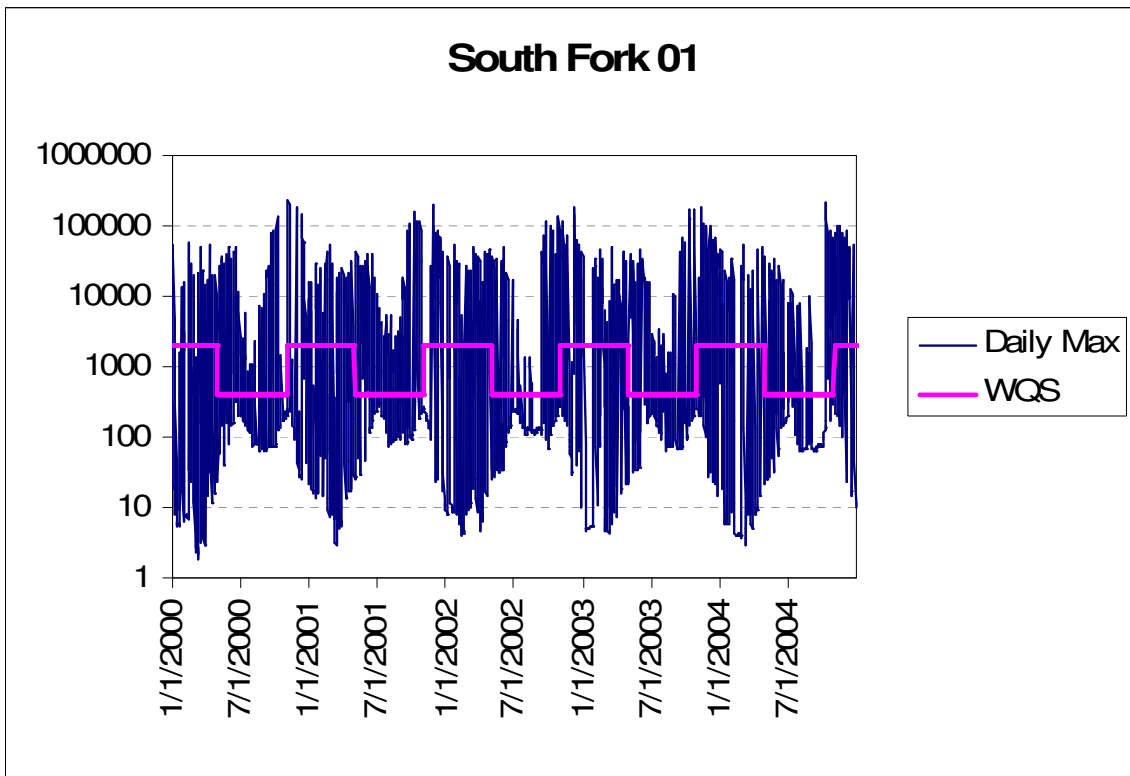


Figure F.12 Daily Max vs. Water Quality Standard Reporting Sub-basin SSF001

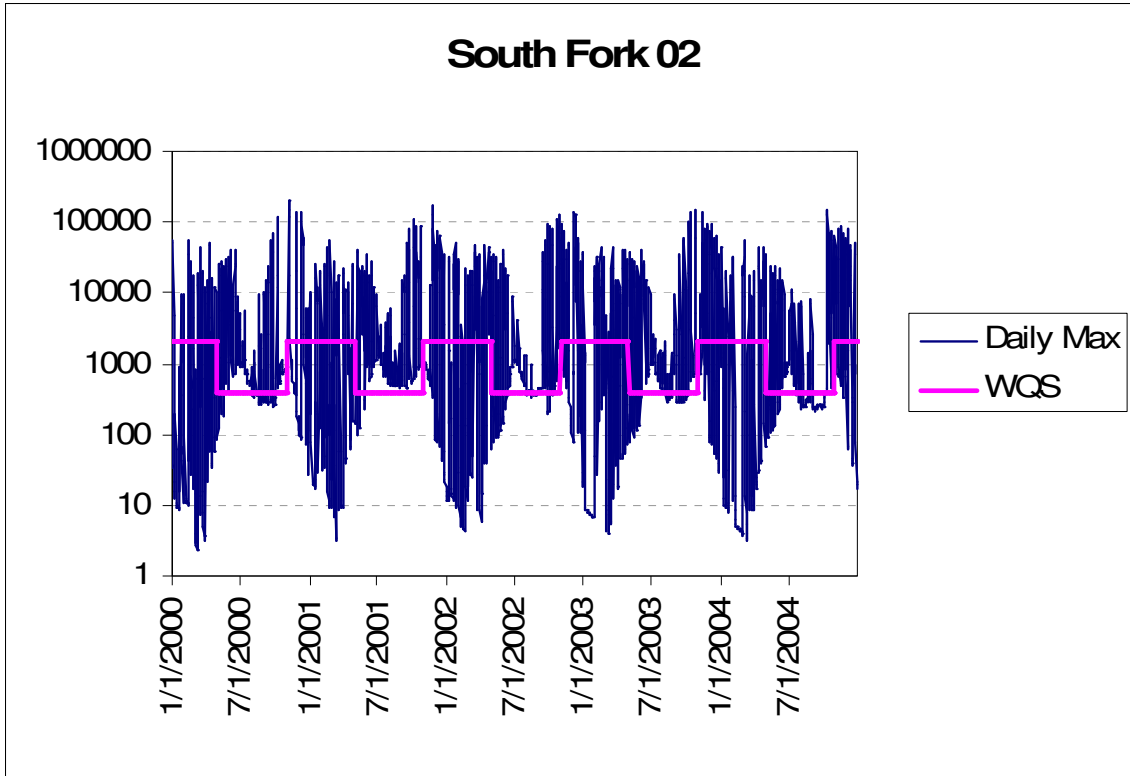


Figure F.13 Daily Max vs. Water Quality Standard Reporting Sub-basin SSF002

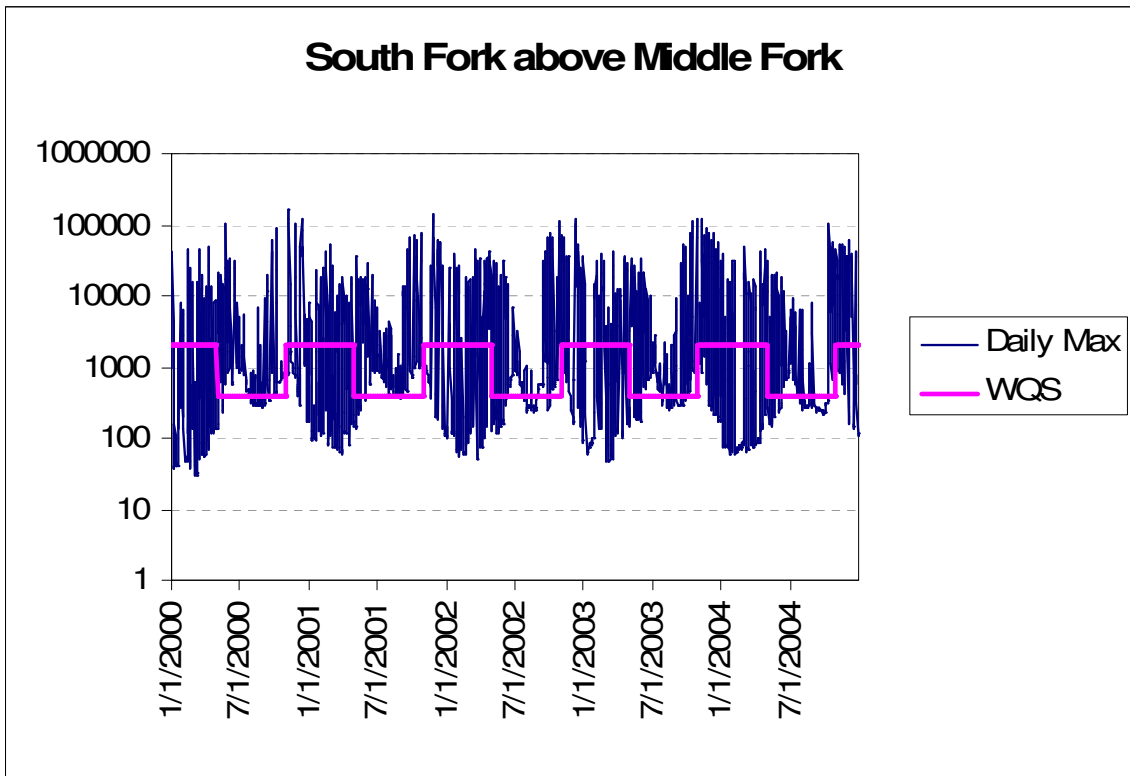


Figure F.14 Daily Max vs. Water Quality Standard Reporting Sub-basin SSF000

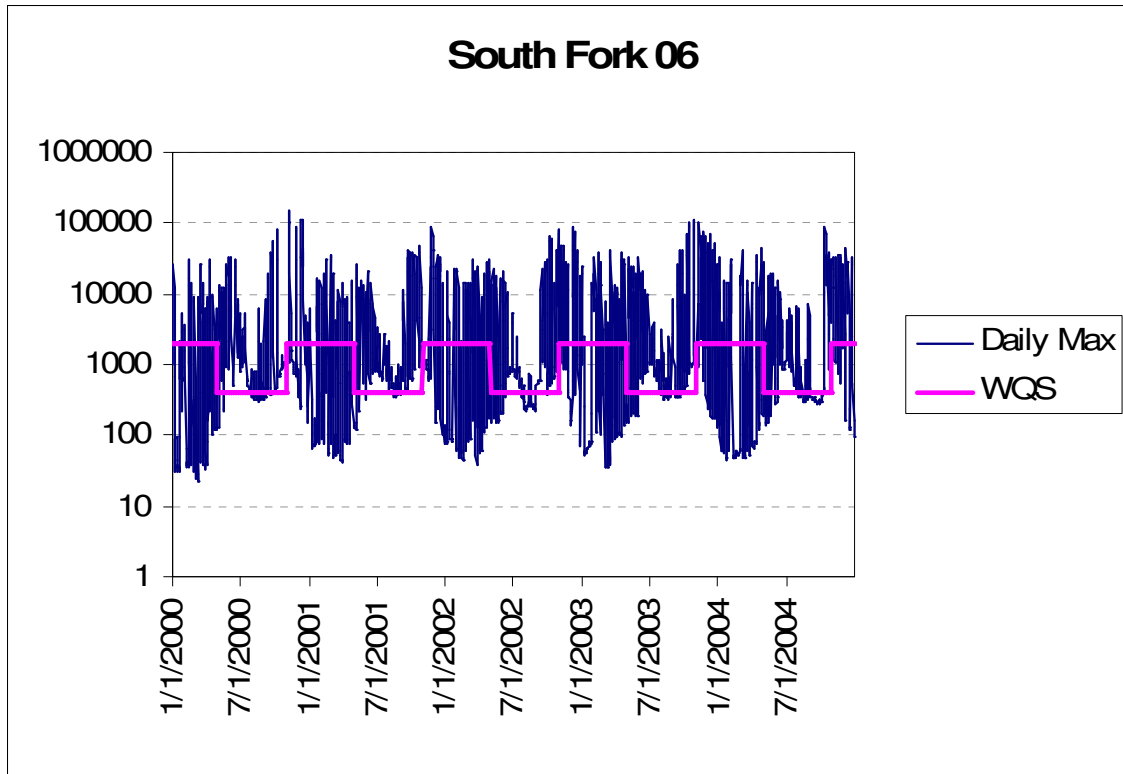


Figure F.15 Daily Max vs. Water Quality Standard Reporting Sub-basin SSF006

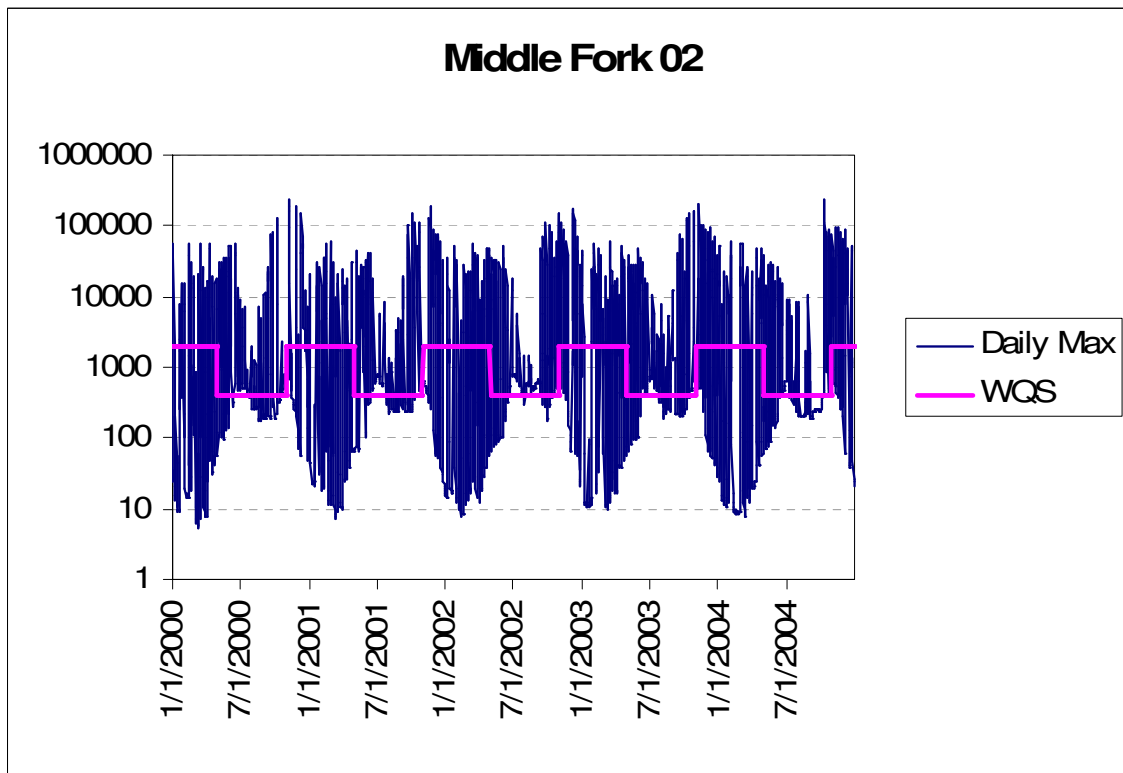


Figure F.16 Daily Max vs. Water Quality Standard Reporting Sub-basin SMI002

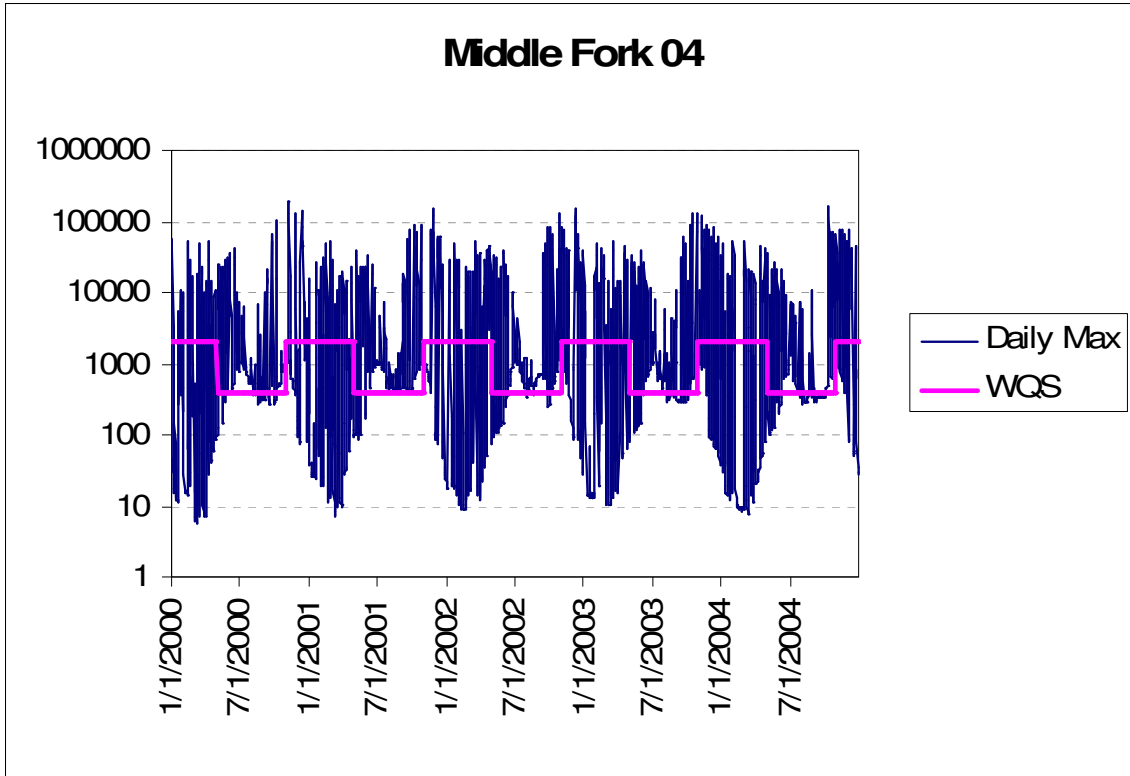


Figure F.17 Daily Max vs. Water Quality Standard Reporting Sub-basin SMI004

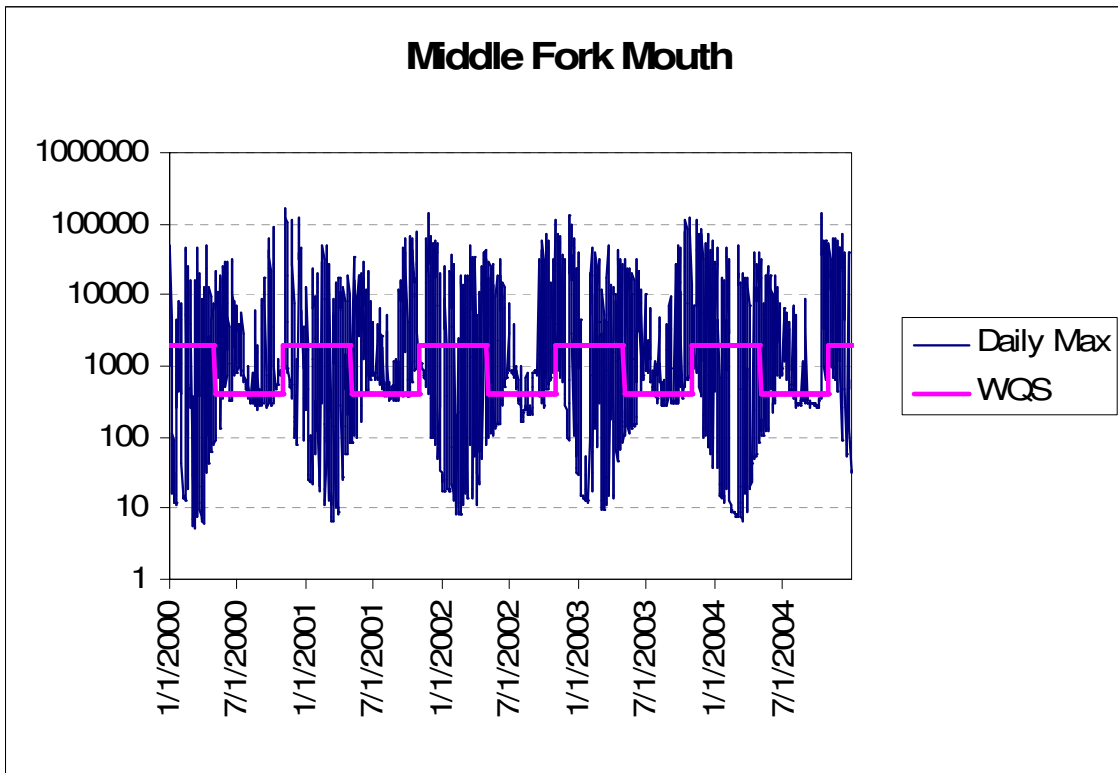


Figure F.18 Daily Max vs. Water Quality Standard Reporting Sub-basin SMI000



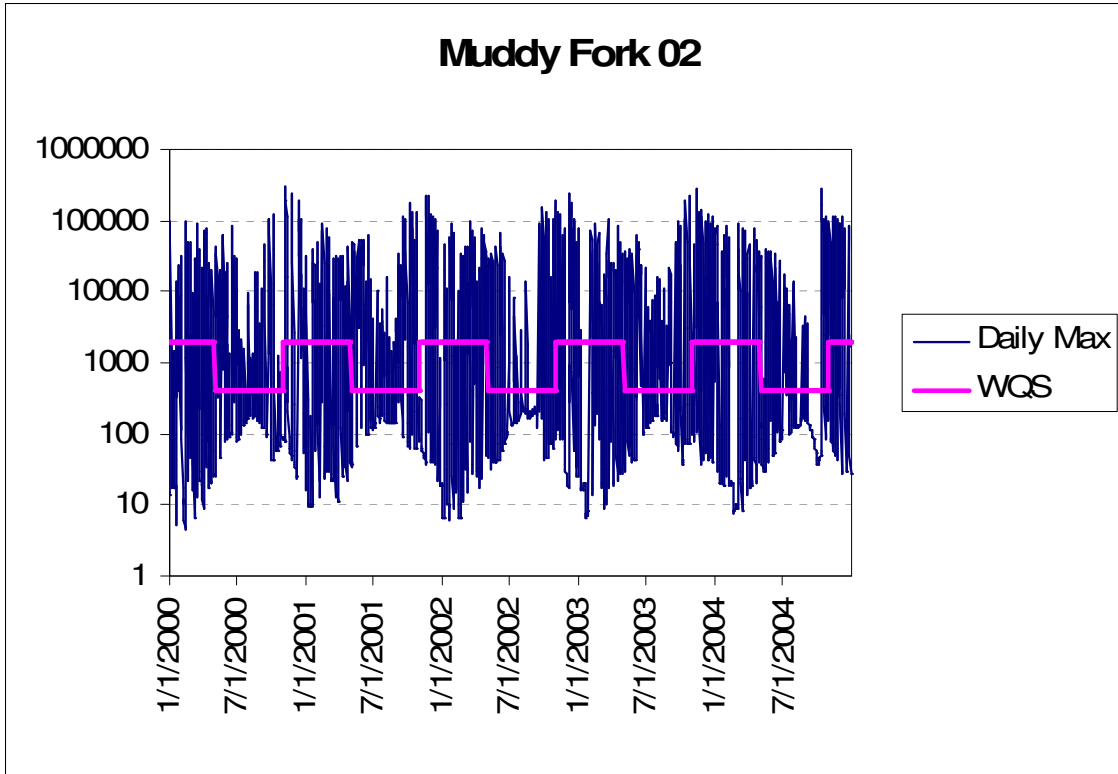


Figure F.19 Daily Max vs. Water Quality Standard Reporting Sub-basin SMU002

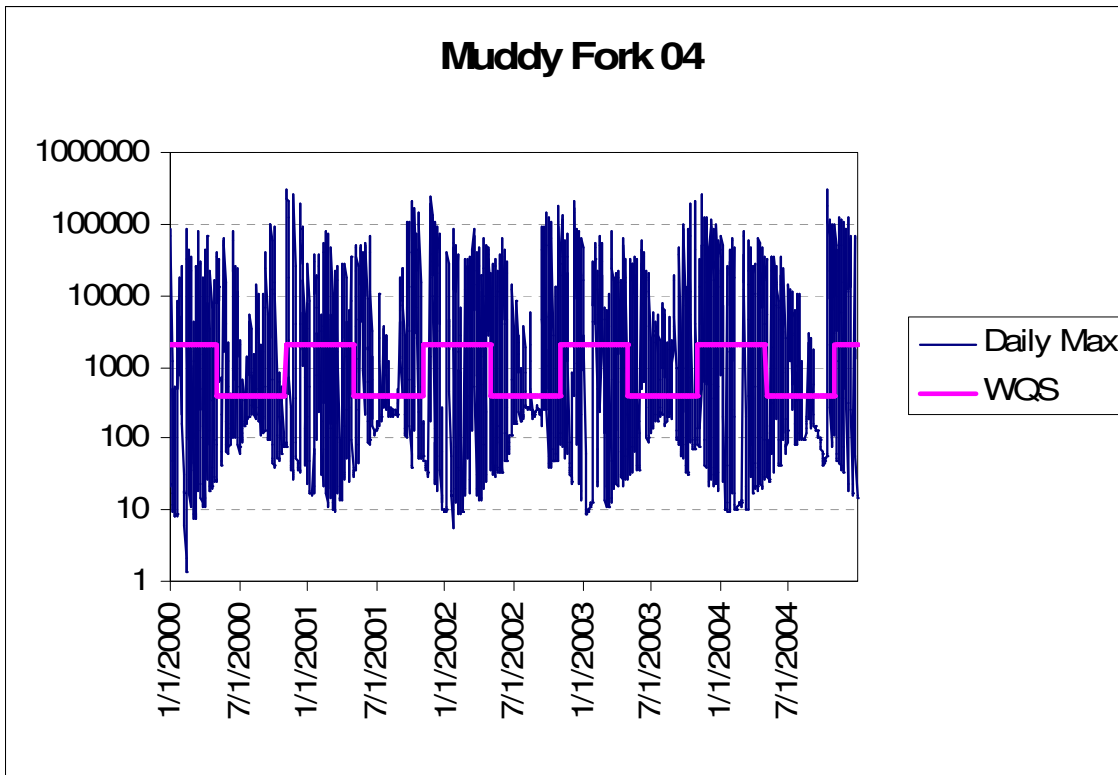


Figure F.20 Daily Max vs. Water Quality Standard Reporting Sub-basin SMU004

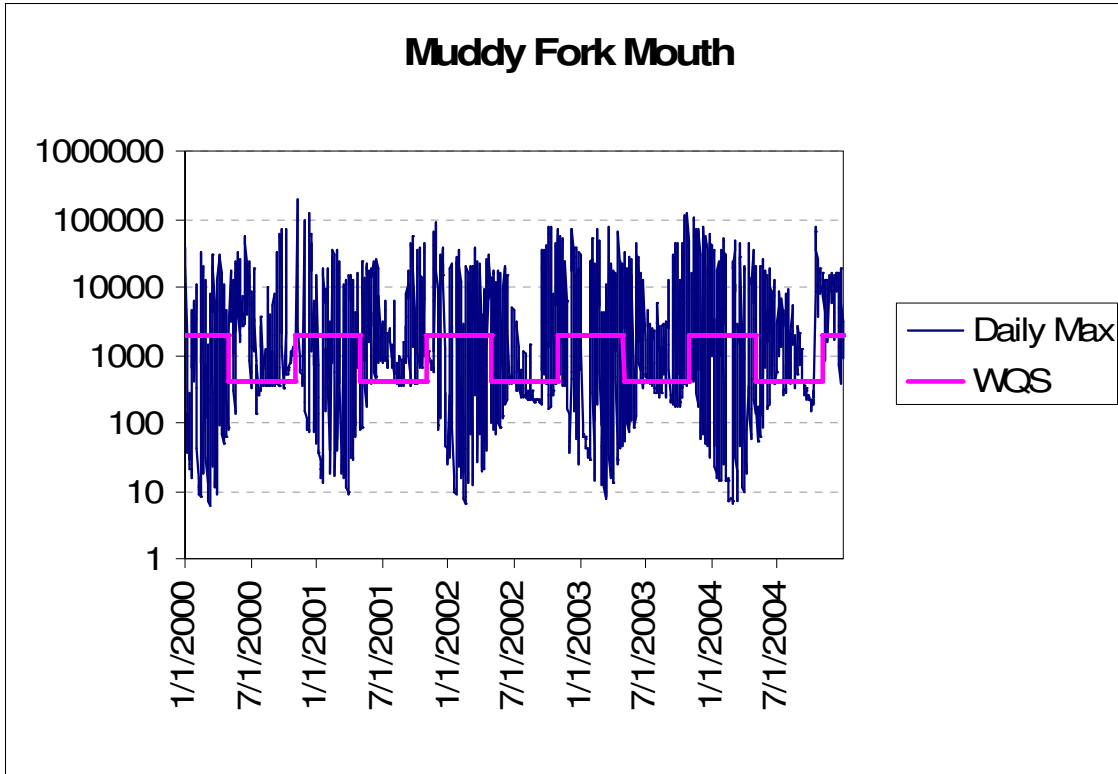


Figure F.21 Daily Max vs. Water Quality Standard Reporting Sub-basin SMU000

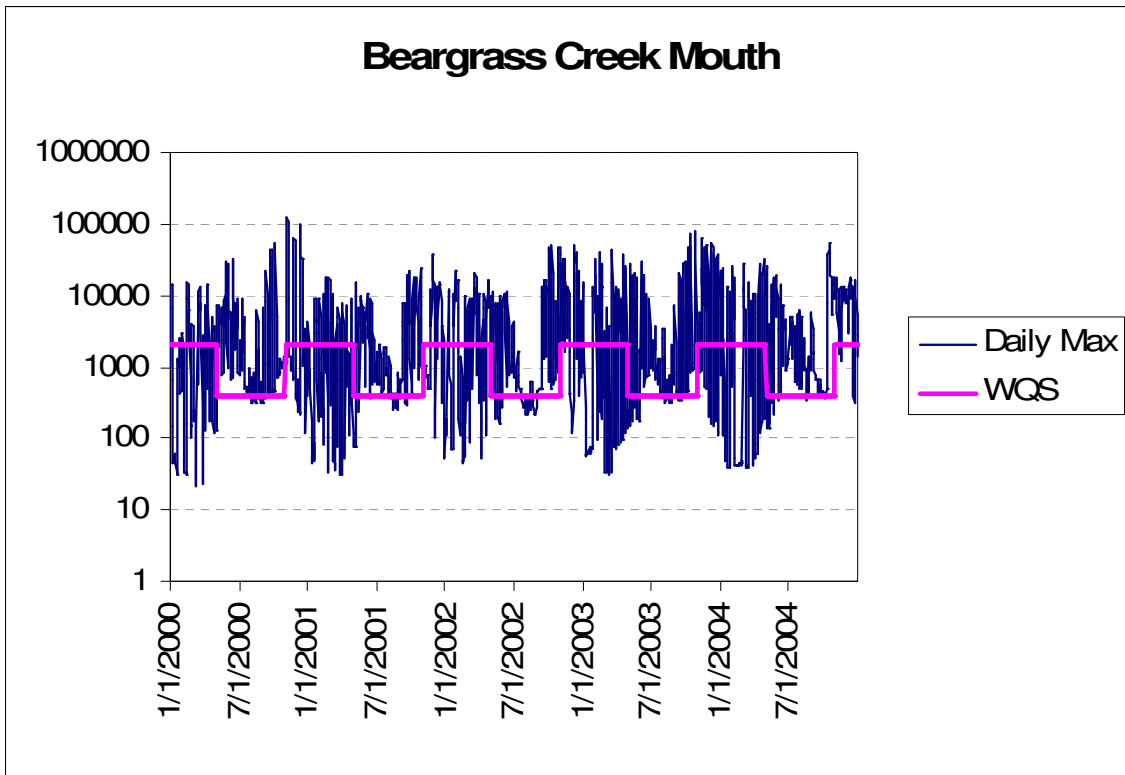


Figure F.22 Daily Max vs. Water Quality Standard Reporting Sub-basin SMS000

**APPENDIX G: EXCURSION FREQUENCIES  
CSO STORAGE/TREATMENT SCENARIO**

**Table G.1 CSO Storage/Treatment Scenario  
 2000 – 2004 Geomean Excursion Frequency (%)**

Sub-Watershed	Reporting Sub-basin	All Data	Season	
			Winter	Recreation
Muddy Fork	SMU004	0.0%	0.0%	0.0%
	SMU002	0.0%	0.0%	0.0%
	SMU000	0.5%	0.3%	0.6%
Middle Fork	SMI002	0.0%	0.0%	0.0%
	SMI004	0.0%	0.0%	0.0%
	SMI000	0.0%	0.0%	0.0%
South Fork	SSF001	0.0%	0.0%	0.0%
	SSF002	0.0%	0.0%	0.0%
	SSF000	0.1%	0.0%	0.1%
	SSF006	0.6%	0.0%	1.2%
Main Stem	SMS000	4.8%	0.7%	8.8%

**Table G.2 CSO Storage/Treatment Scenario  
 2000 – 2004 Max Excursion Frequency (%)**

Sub-Watershed	Reporting Sub-basin	All Data	Season	
			Winter	Recreation
Muddy Fork	SMU004	7.1	3.7	10.5
	SMU002	6.6	3.5	9.8
	SMU000	7.7	2.4	12.9
Middle Fork	SMI002	6.5	3.0	10.0
	SMI004	7.5	3.2	11.7
	SMI000	7.7	3.2	12.1
South Fork	SSF001	6.8	3.1	10.4
	SSF002	9.0	5.3	12.6
	SSF000	9.4	5.1	13.6
	SSF006	9.8	2.8	16.7
Main Stem	SMS000	9.6	1.6	17.5

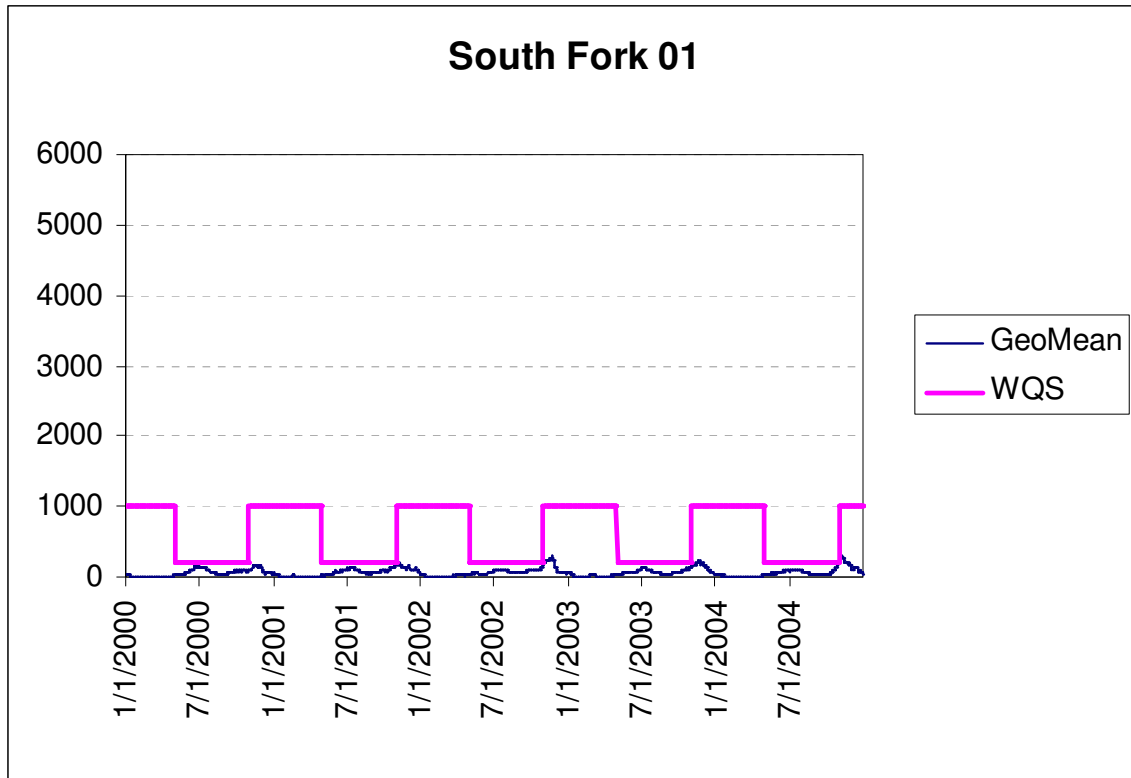


Figure G.1 Geomean vs. Water Quality Standard Reporting Sub-basin SSF001

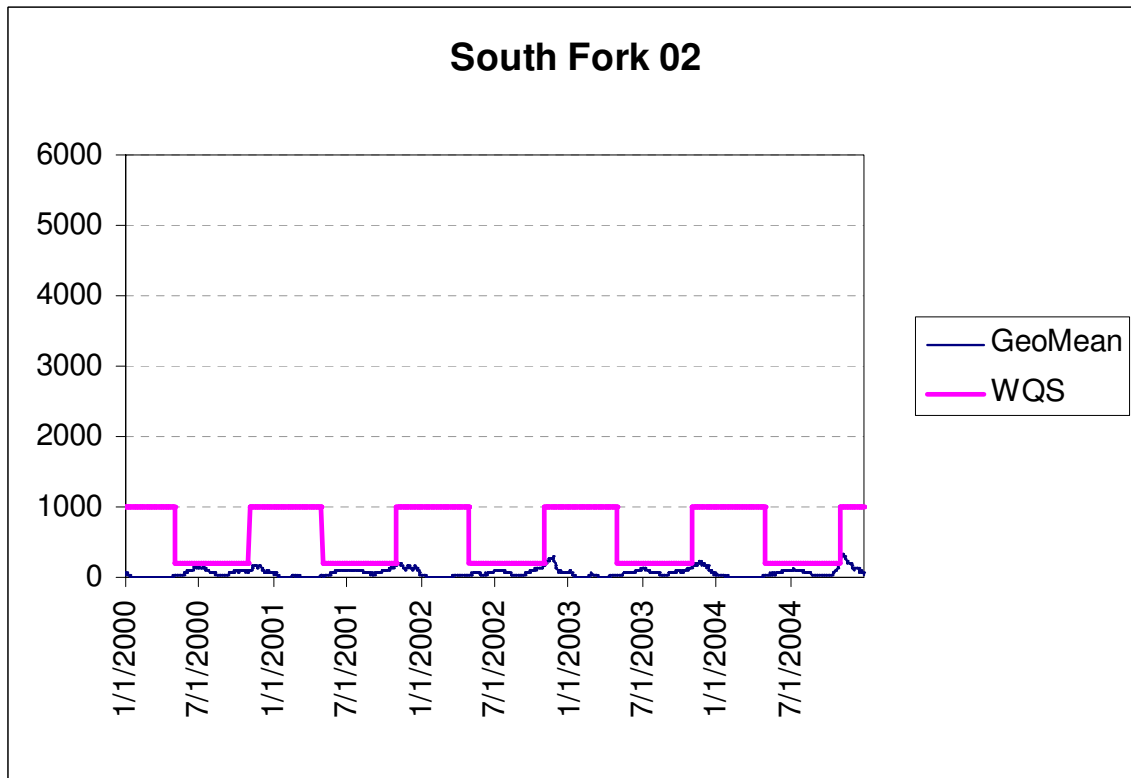
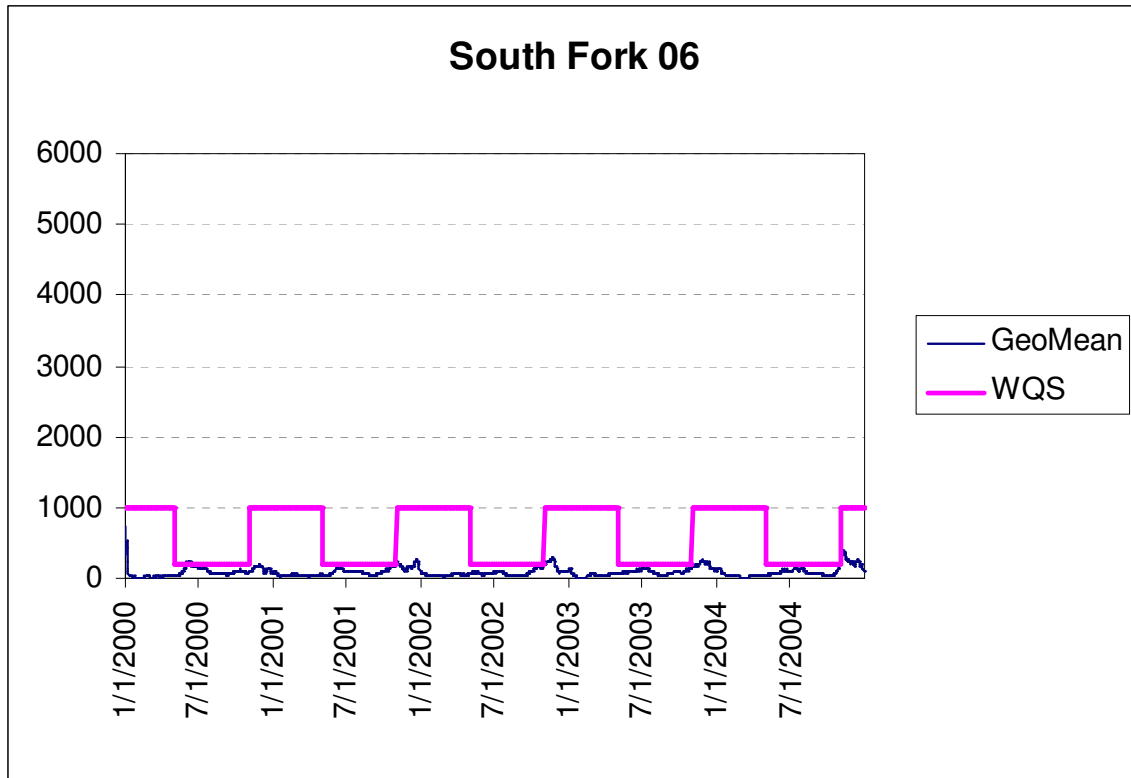
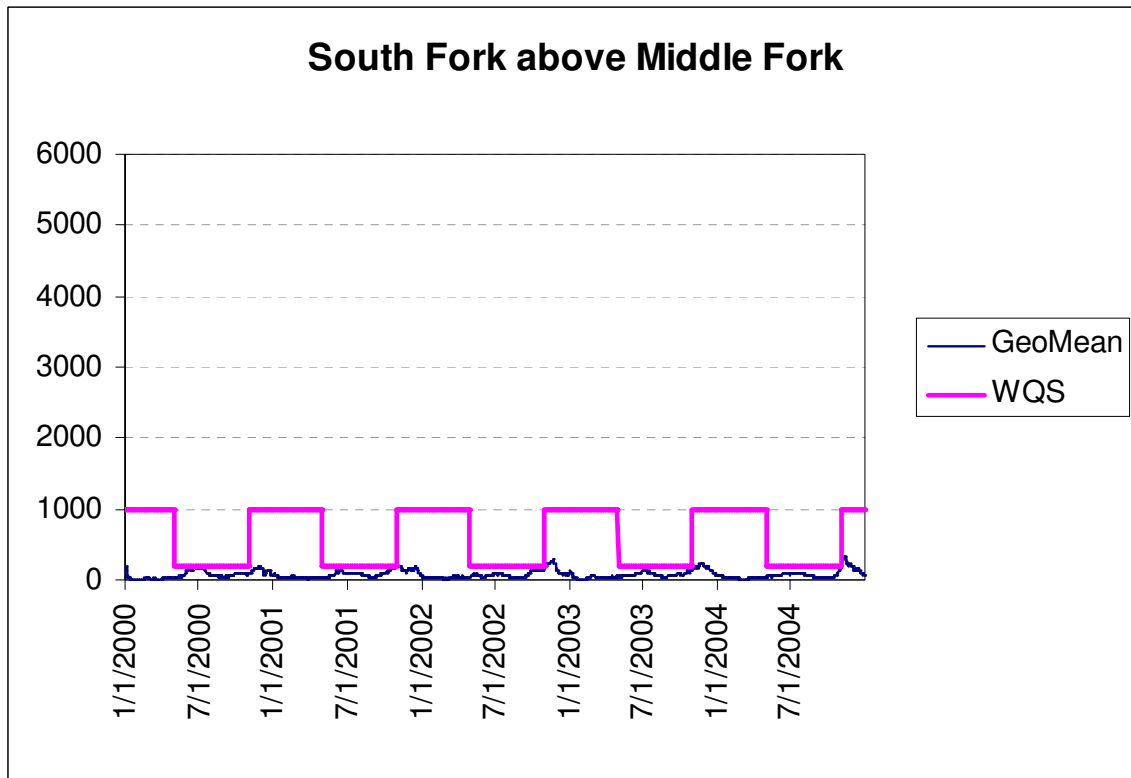


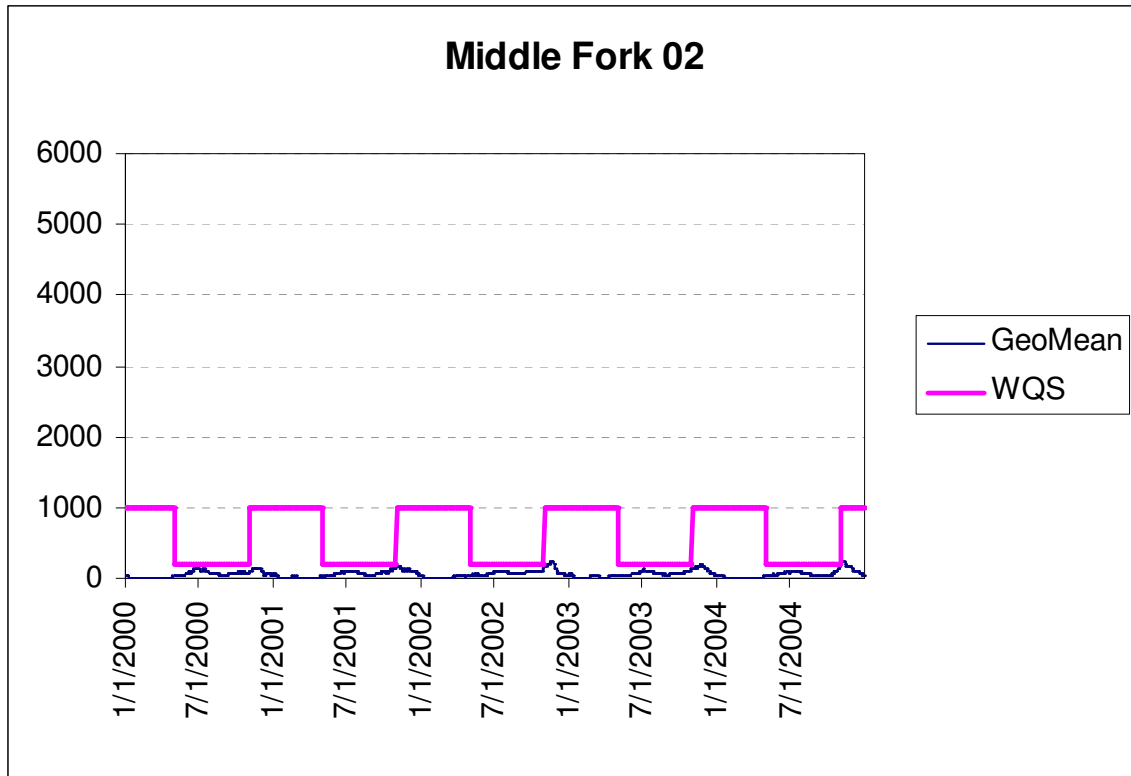
Figure G.2 Geomean vs. Water Quality Standard Reporting Sub-basin SSF002



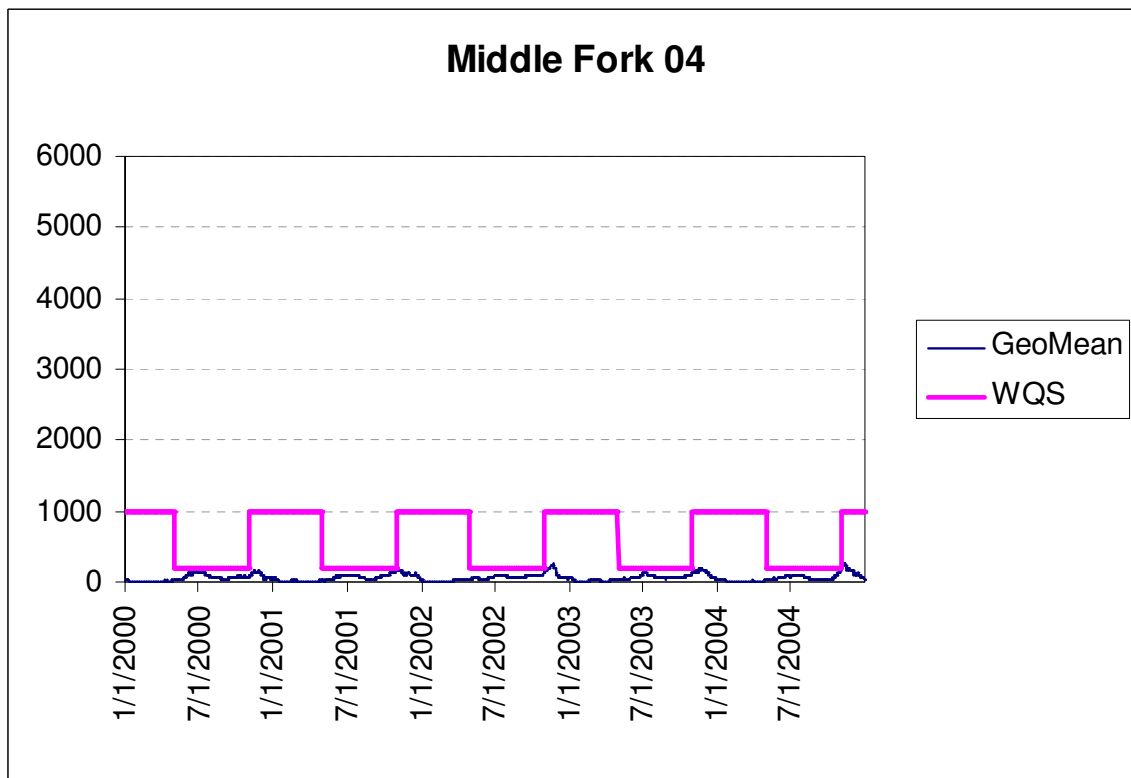
**Figure G.3 Geomean vs. Water Quality Standard Reporting Sub-basin SSF006**



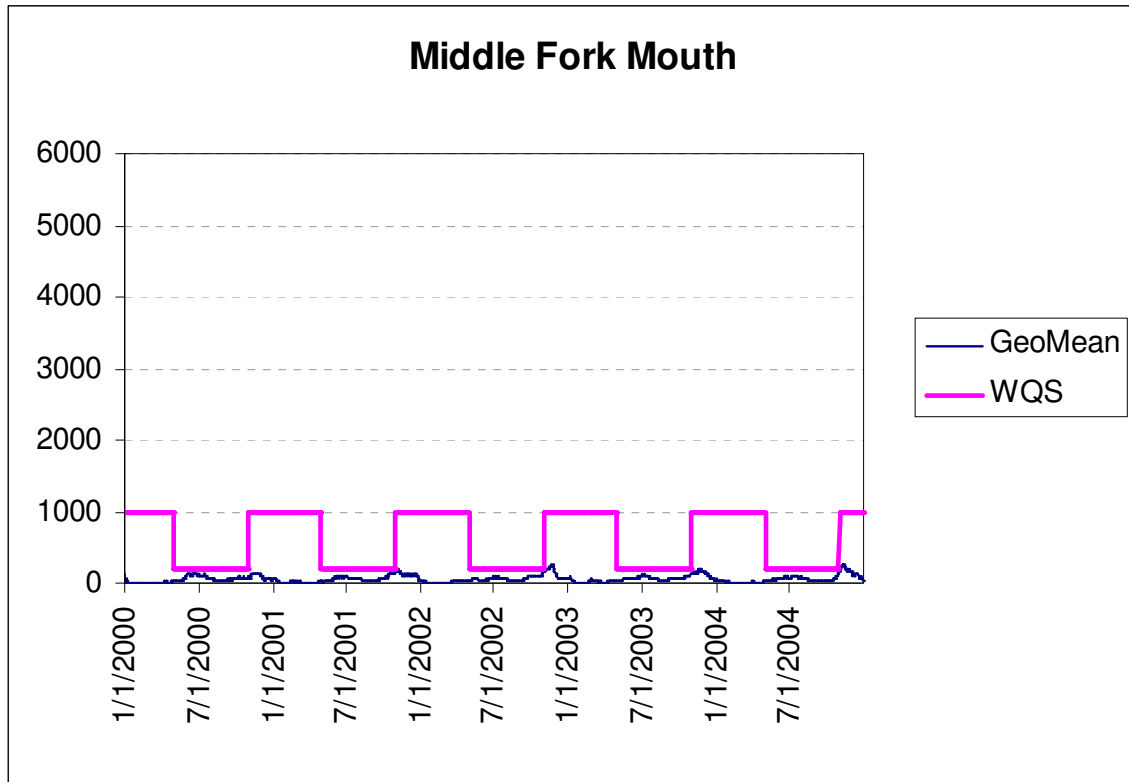
**Figure G.4 Geomean vs. Water Quality Standard Reporting Sub-basin SSF000**



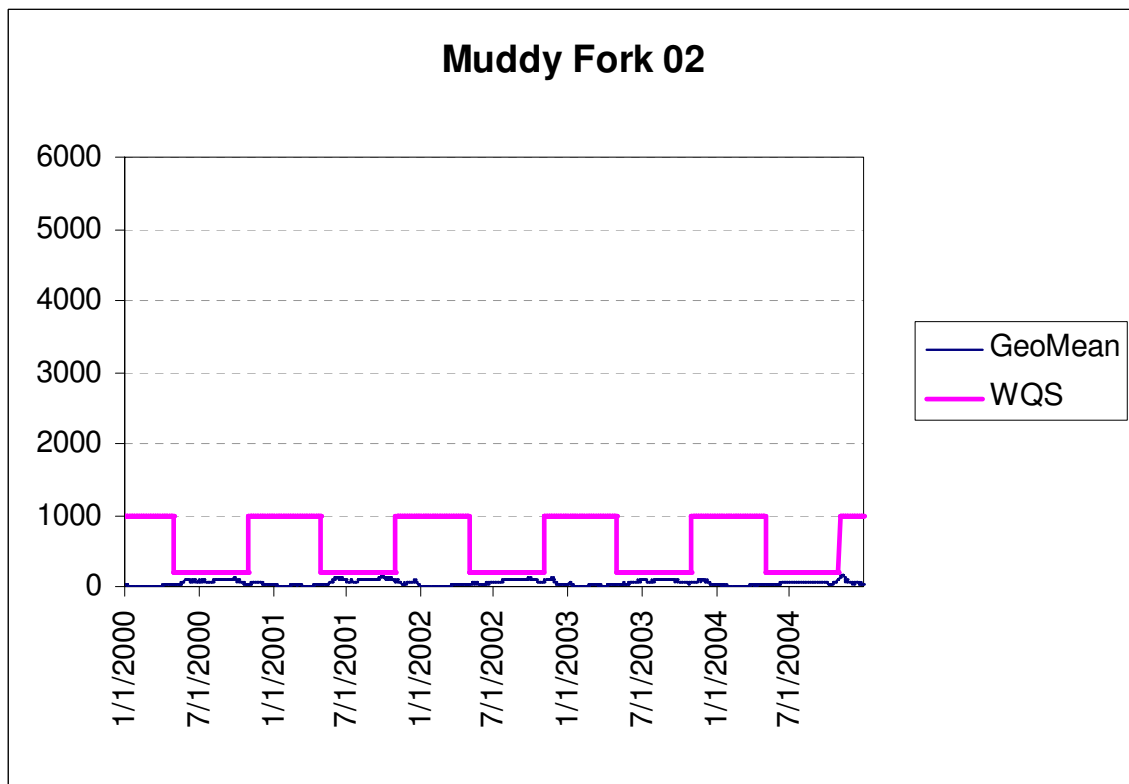
**Figure G.5 Geomean vs. Water Quality Standard Reporting Sub-basin SMI002**



**Figure G.6 Geomean vs. Water Quality Standard Reporting Sub-basin SMI004**



**Figure G.7 Geomean vs. Water Quality Standard Reporting Sub-basin SMI000**



**Figure G.8 Geomean vs. Water Quality Standard Reporting Sub-basin SMU002**



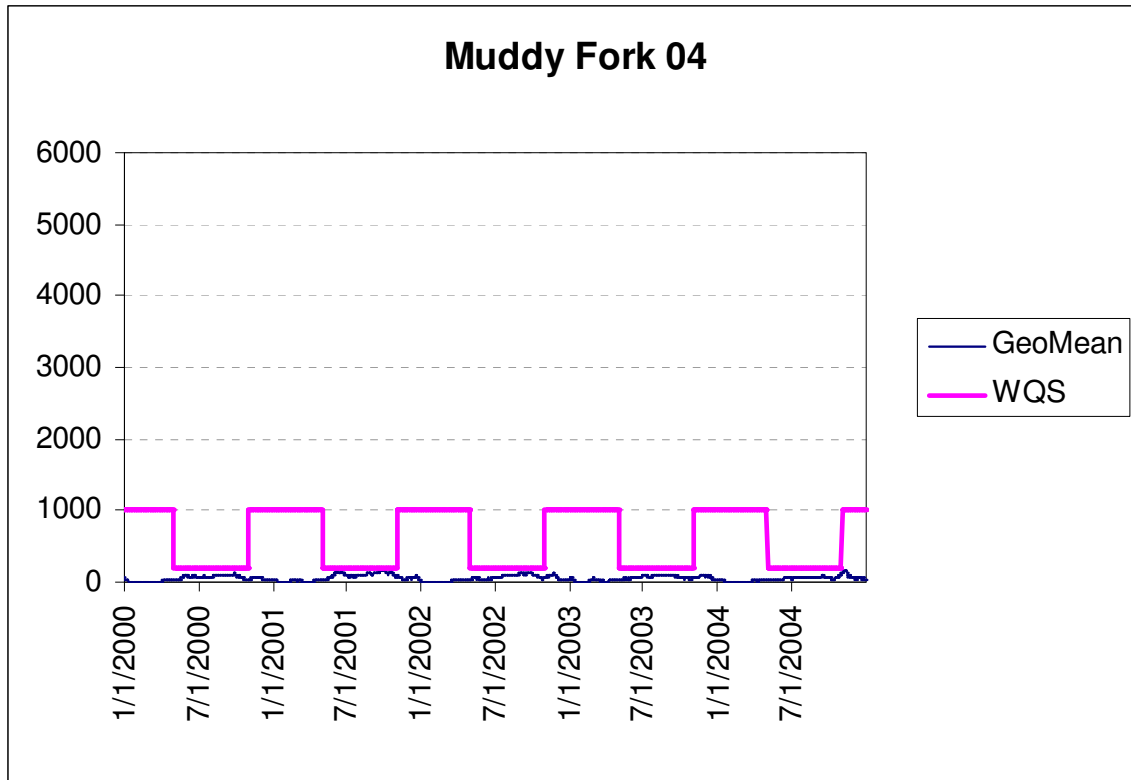


Figure G.9 Geomean vs. Water Quality Standard Reporting Sub-basin SMU004

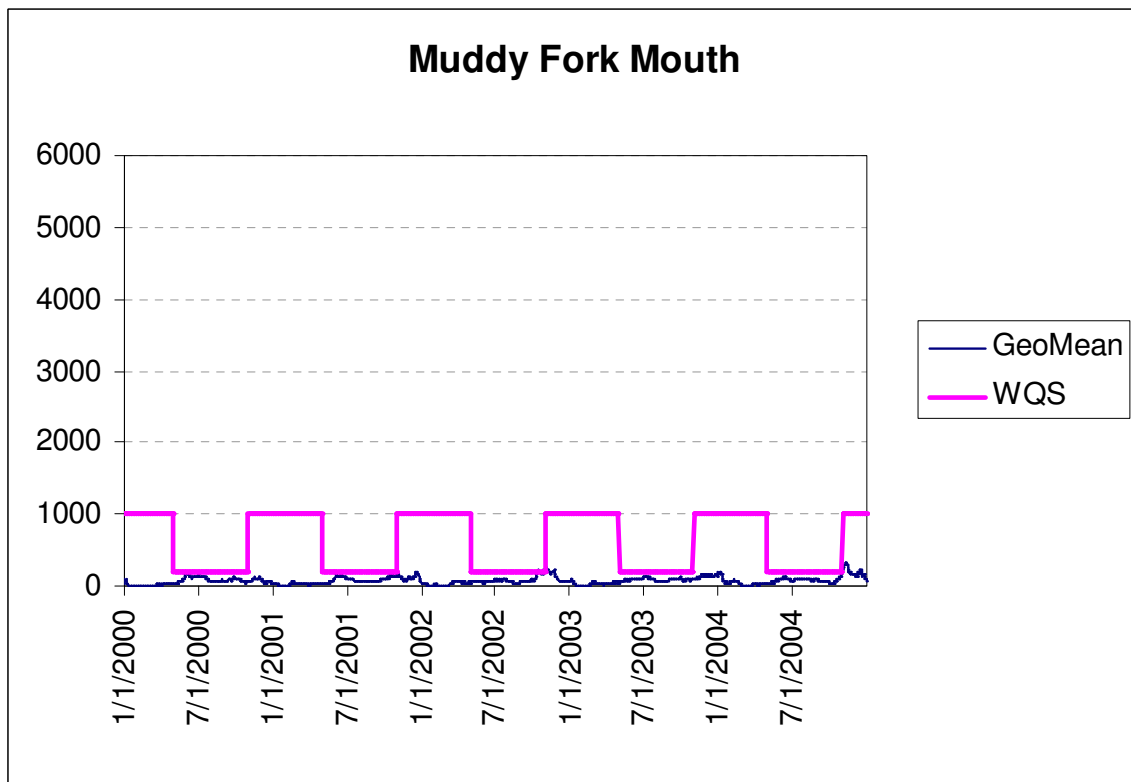


Figure G.10 Geomean vs. Water Quality Standard Reporting Sub-basin SMU000

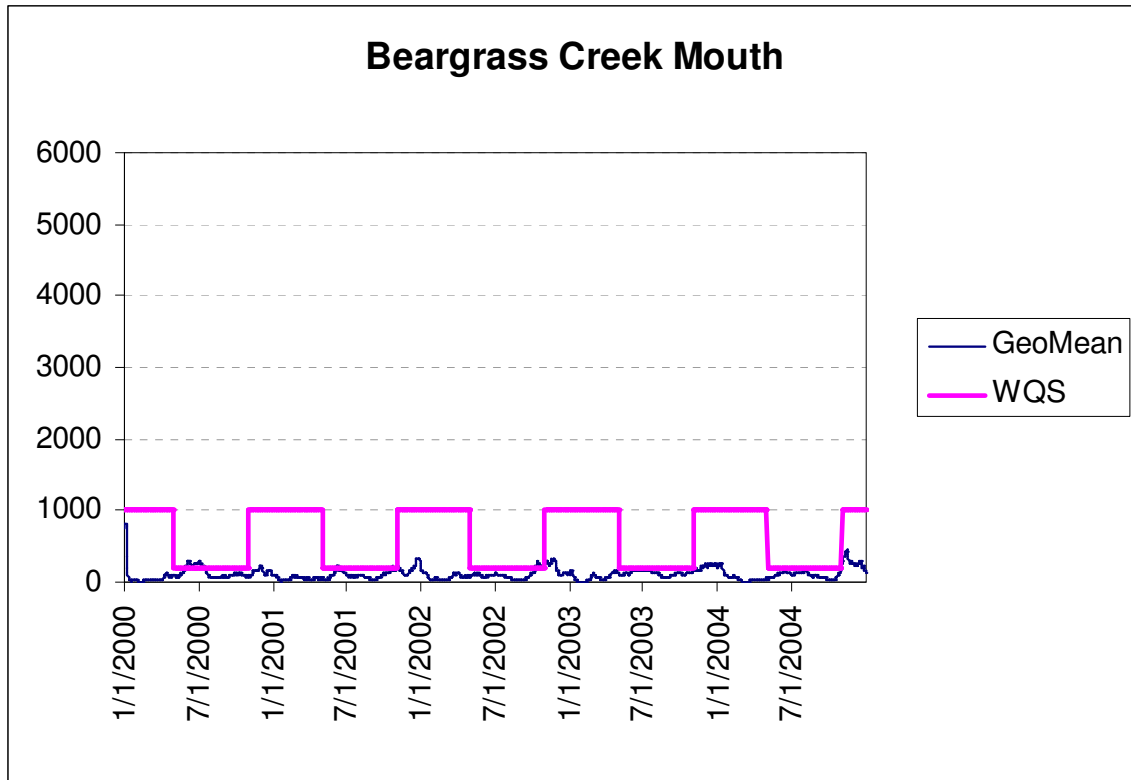


Figure G.11 Geomean vs. Water Quality Standard Reporting Sub-basin SMS000

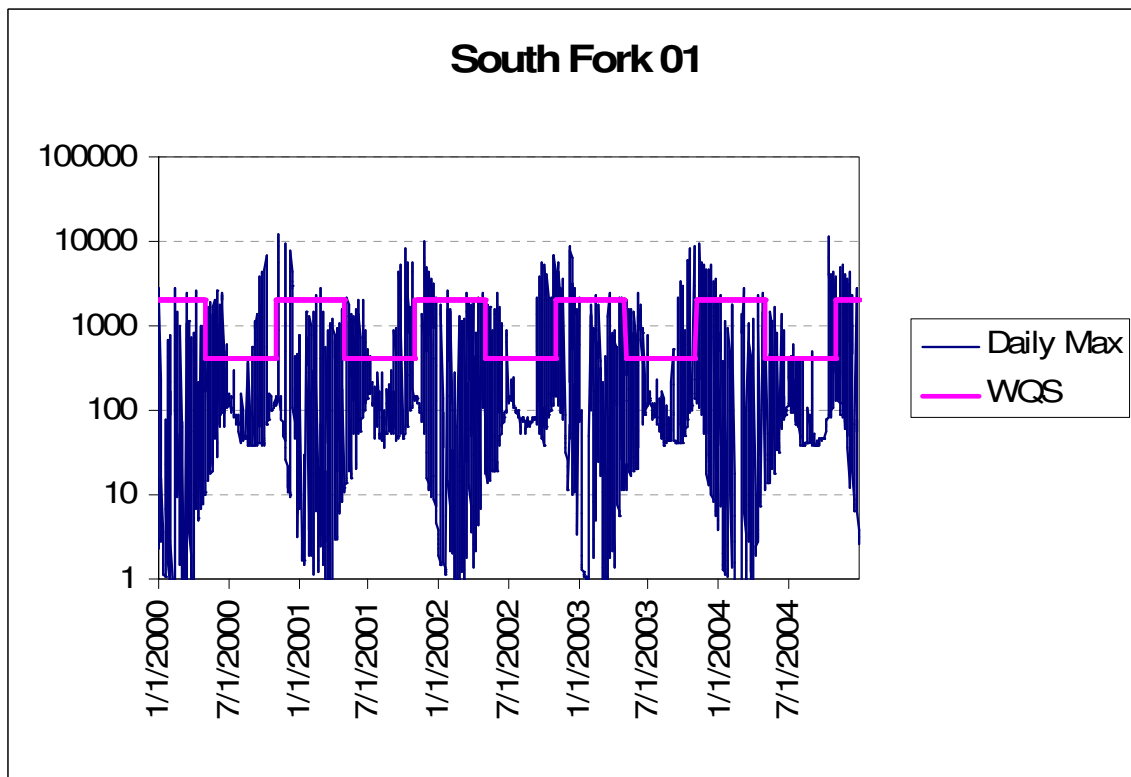


Figure G.12 Daily Max vs. Water Quality Standard Reporting Sub-basin SSF001

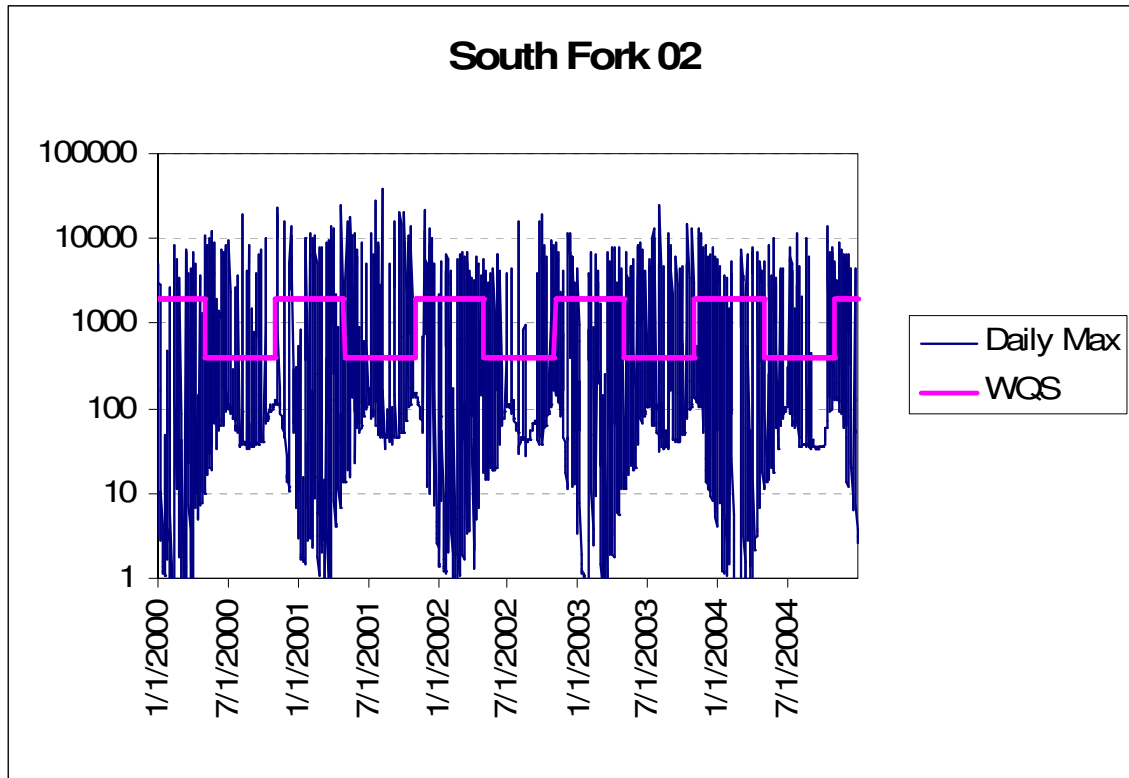


Figure G.13 Daily Max vs. Water Quality Standard Reporting Sub-basin SSF002

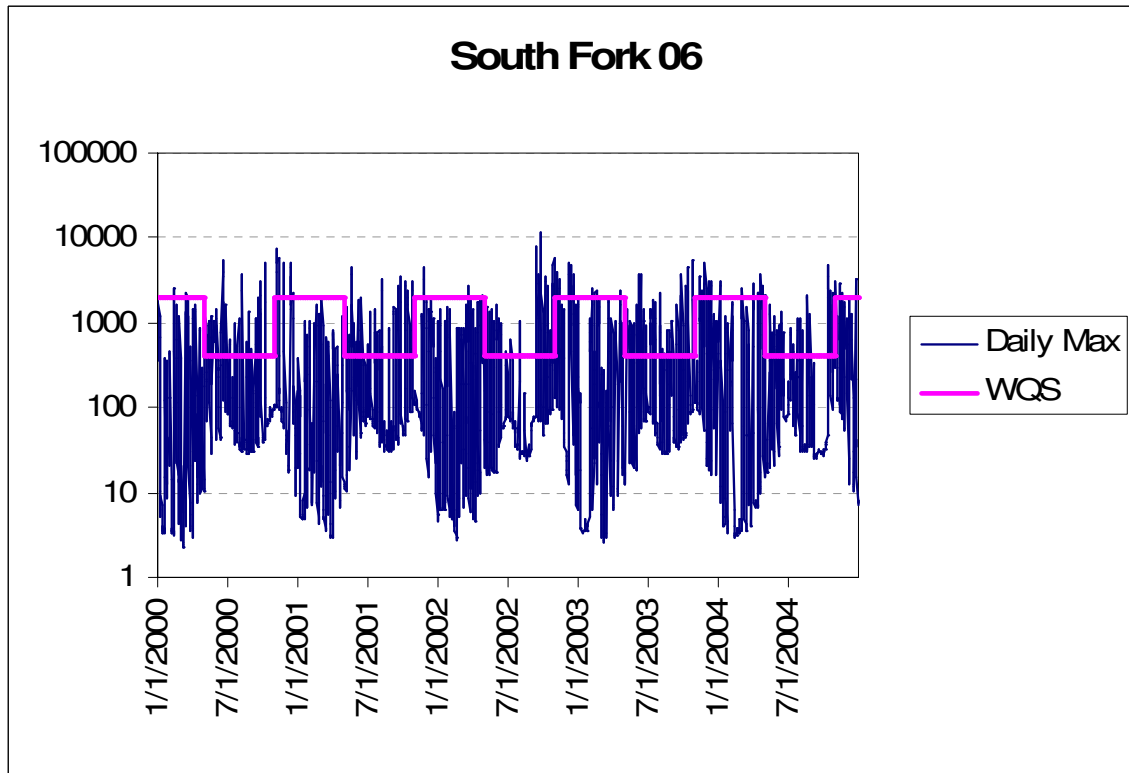


Figure G.14 Daily Max vs. Water Quality Standard Reporting Sub-basin SSF006

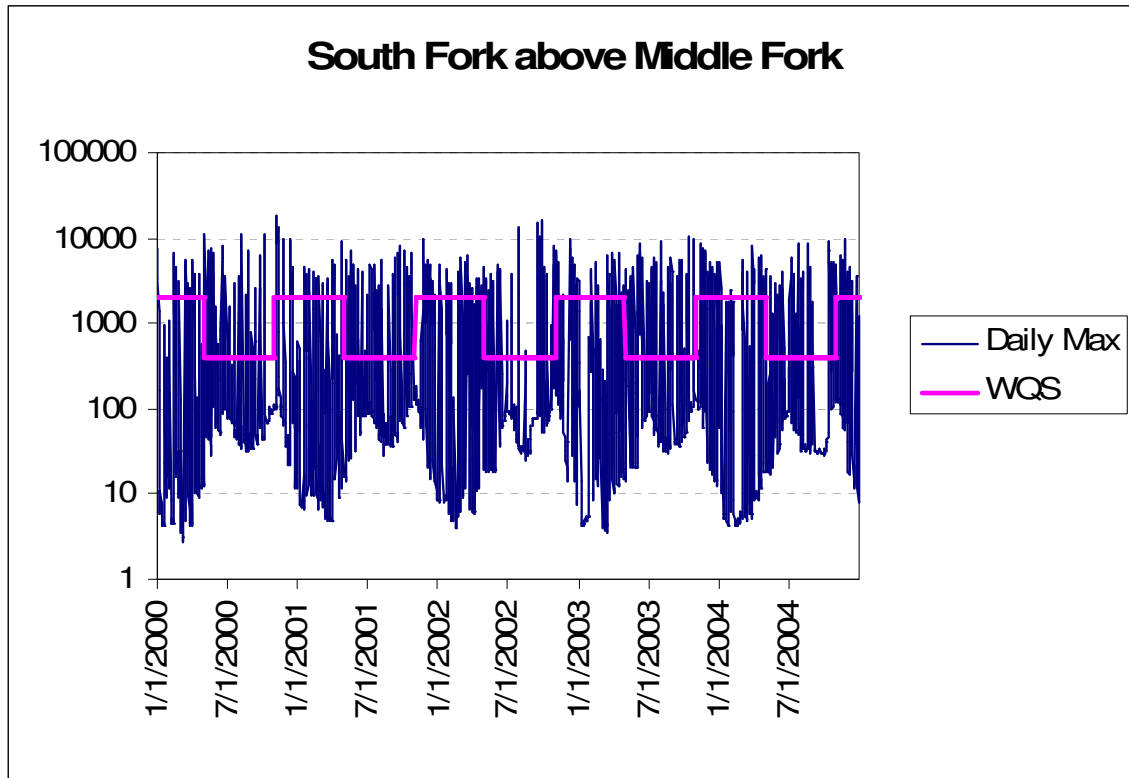


Figure G.15 Daily Max vs. Water Quality Standard Reporting Sub-basin SSF000

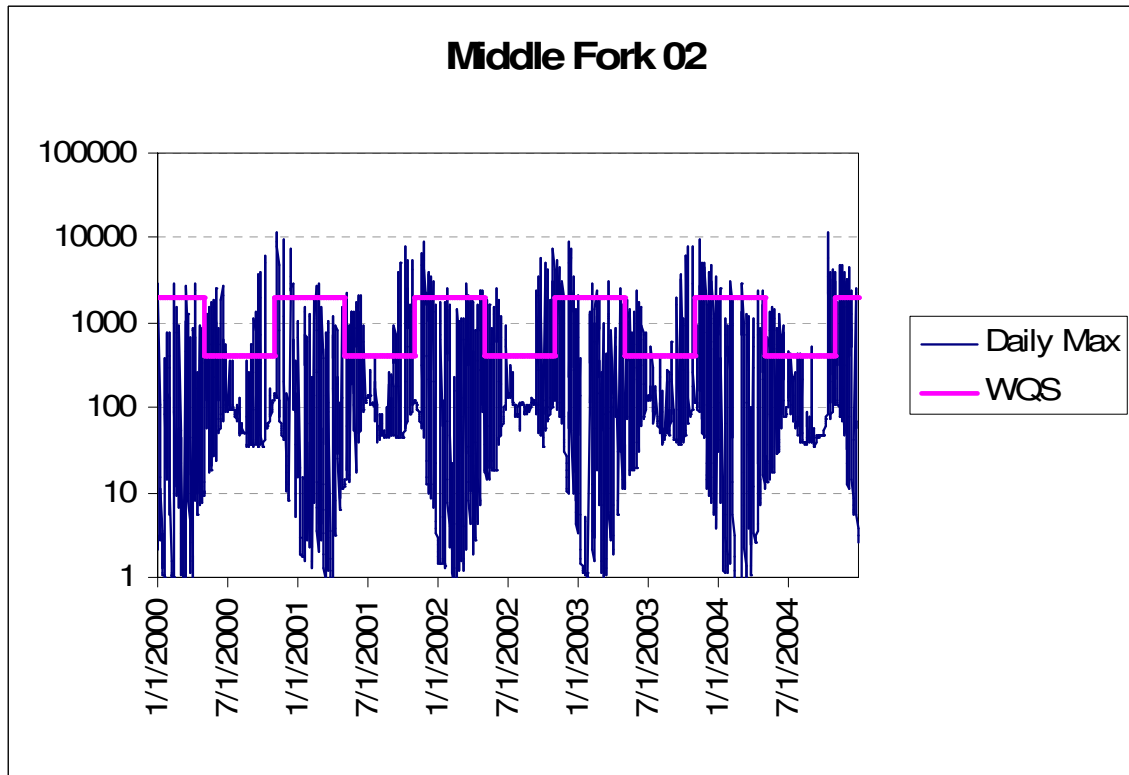


Figure G.16 Daily Max vs. Water Quality Standard Reporting Sub-basin SMI002

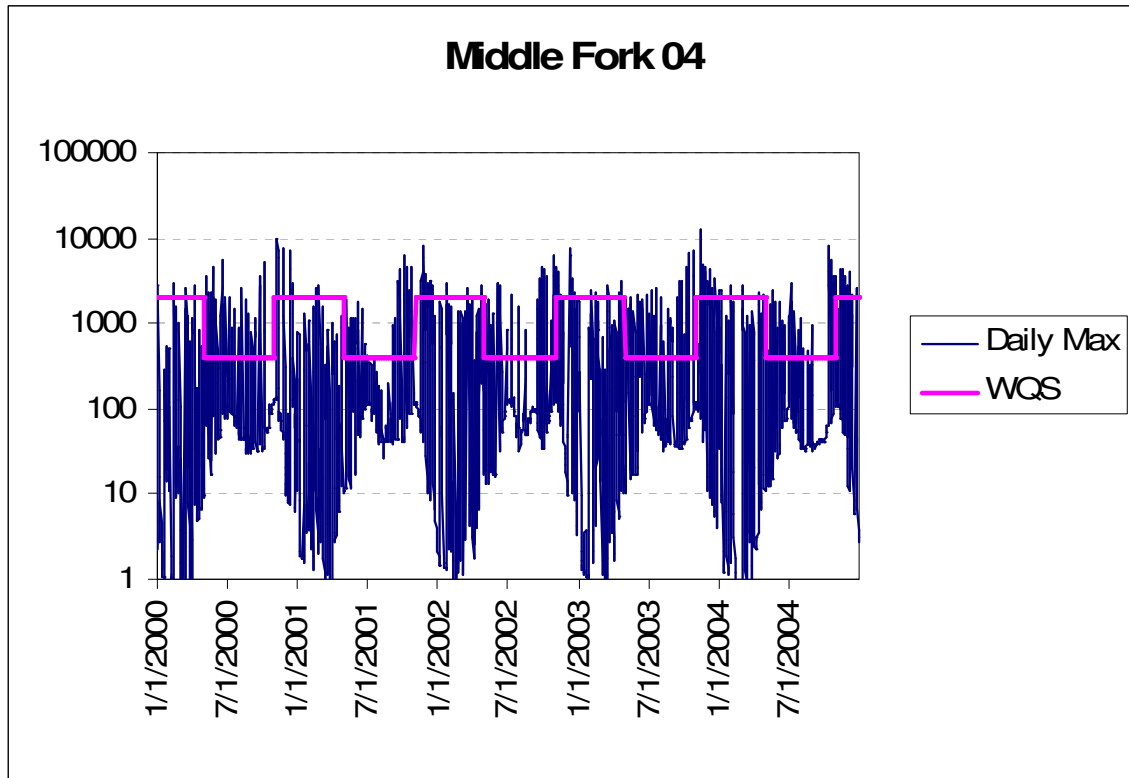


Figure G.17 Daily Max vs. Water Quality Standard Reporting Sub-basin SMI004

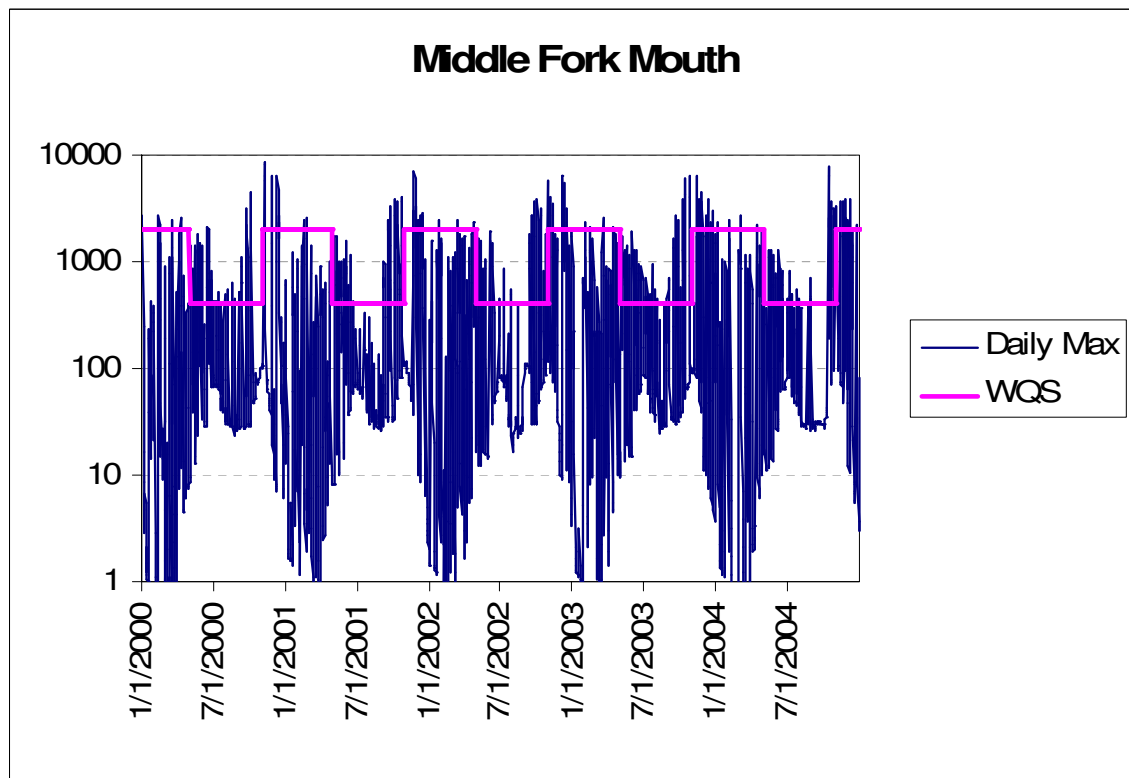


Figure G.18 Daily Max vs. Water Quality Standard Reporting Sub-basin SMI000

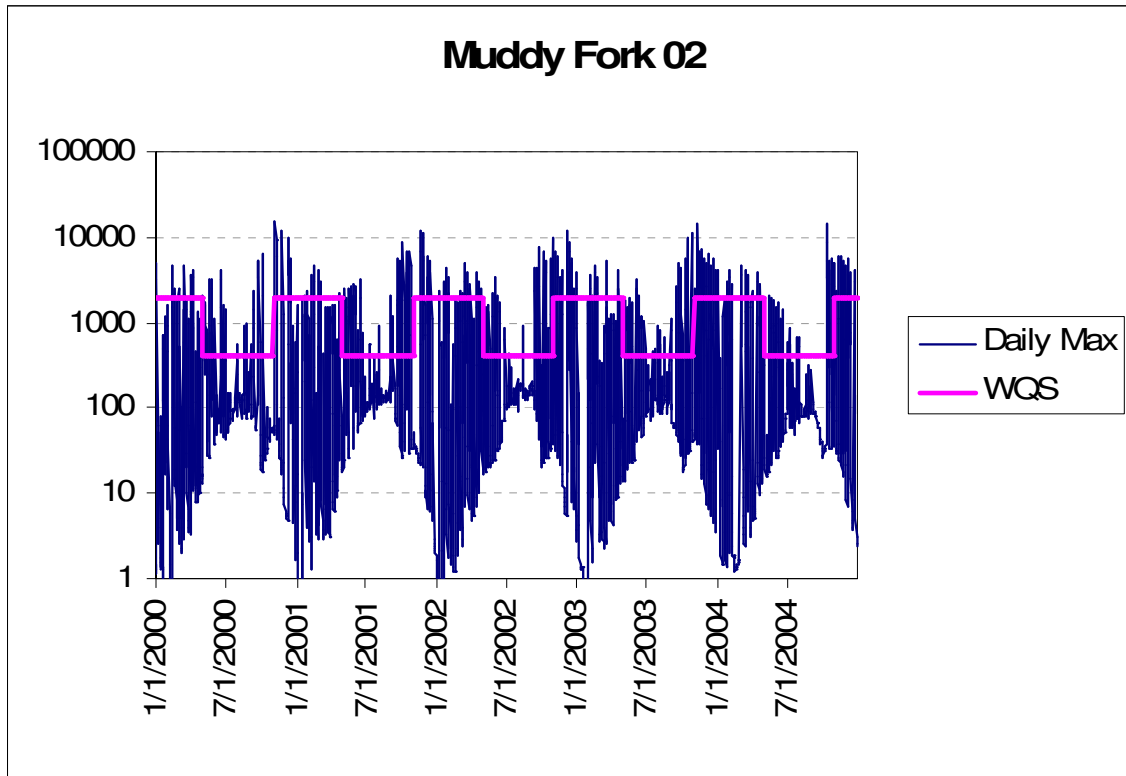


Figure G.19 Daily Max vs. Water Quality Standard Reporting Sub-basin SMU002

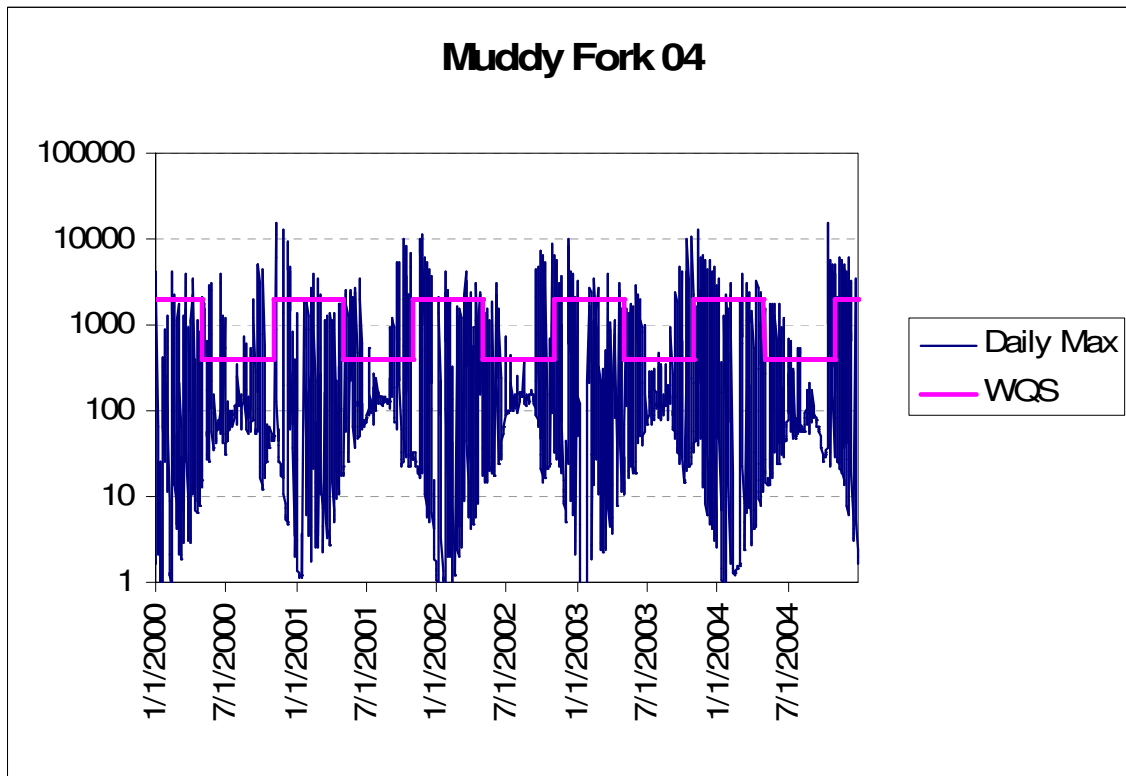


Figure G.20 Daily Max vs. Water Quality Standard Reporting Sub-basin SMU004

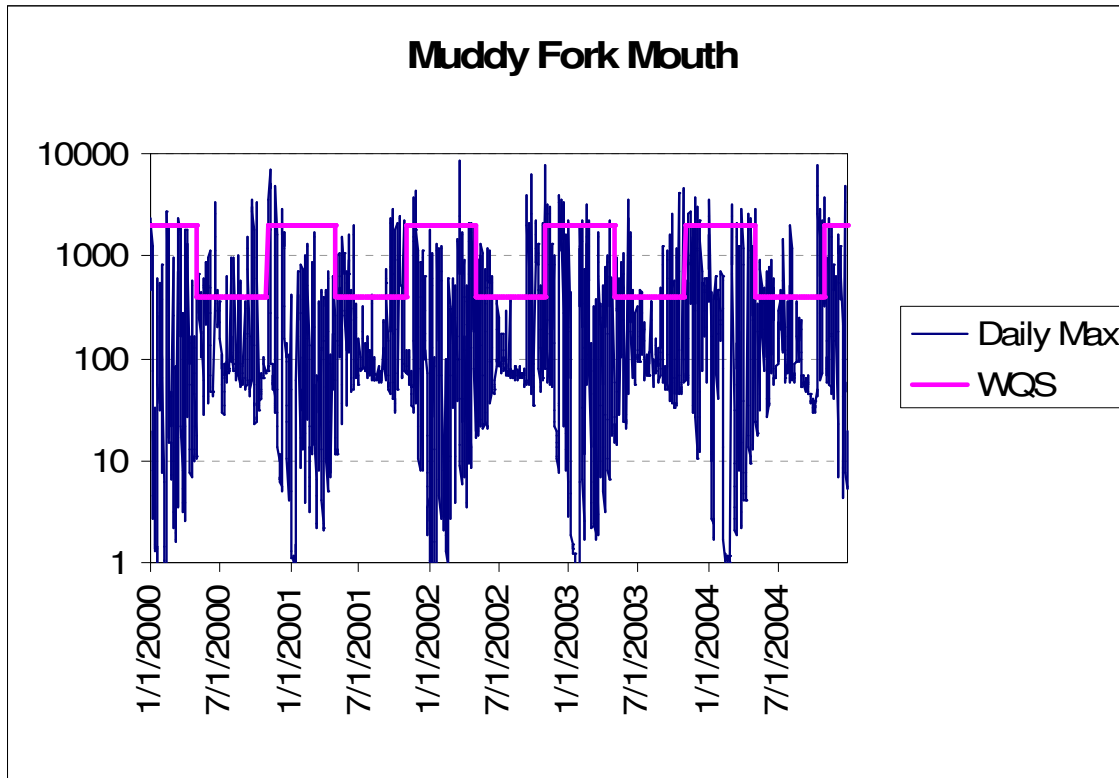


Figure G.21 Daily Max vs. Water Quality Standard Reporting Sub-basin SMU000

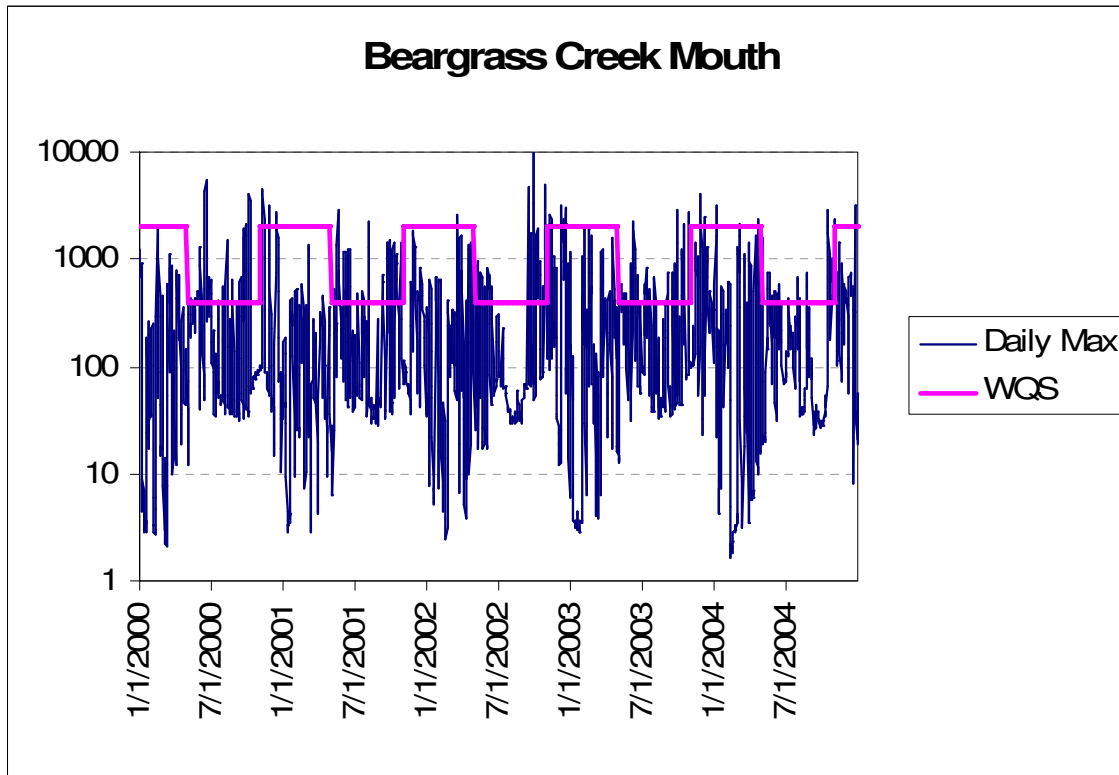


Figure G.22 Daily Max vs. Water Quality Standard Reporting Sub-basin SMS000

**APPENDIX H: EXCURSION FREQUENCIES  
SEWER SEPARATION SCENARIO**

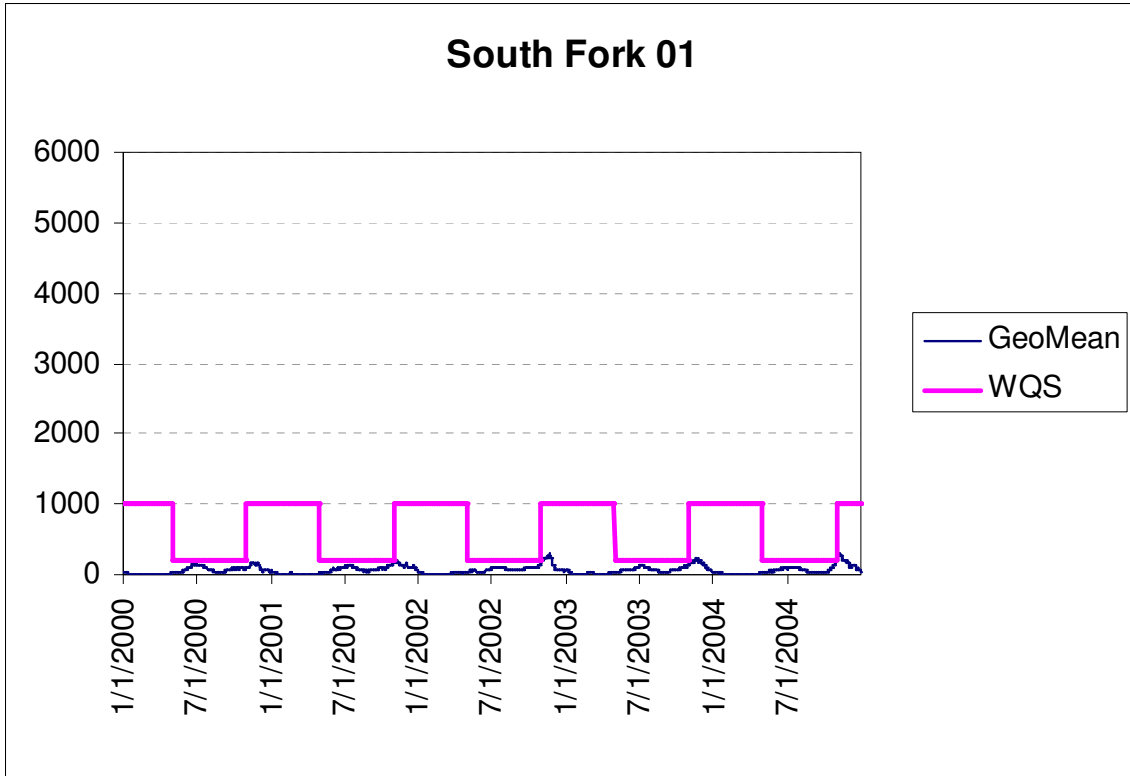


**Table H.1 Sewer Sep. Scenario 2000 – 2004 Geomean Excursion Frequency (%)**

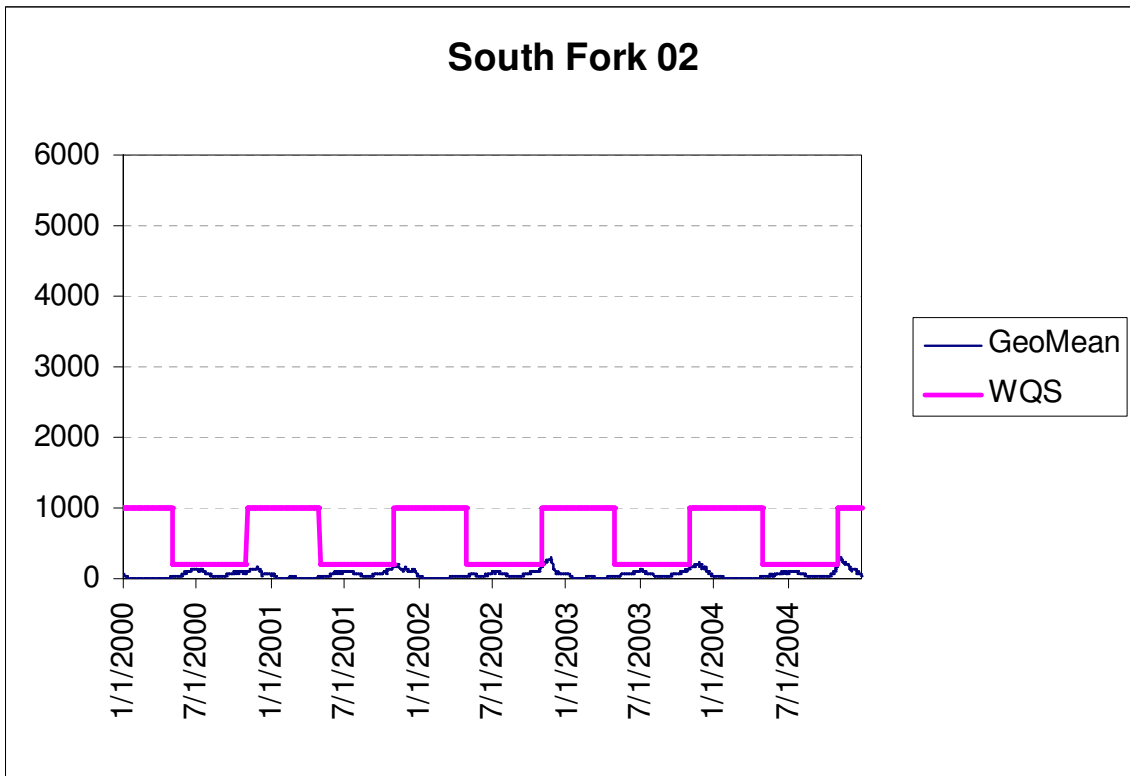
Sub-Watershed	Reporting Sub-basin	All	Season	
		Data	Winter	Recreation
Muddy Fork	SMU004	0.0%	0.0%	0.0%
	SMU002	0.0%	0.0%	0.0%
	SMU000	0.6%	0.7%	0.4%
Middle Fork	SMI002	0.0%	0.0%	0.0%
	SMI004	0.0%	0.0%	0.0%
	SMI000	0.0%	0.0%	0.0%
South Fork	SSF001	0.3%	0.5%	0.0%
	SSF002	0.0%	0.0%	0.0%
	SSF000	0.0%	0.0%	0.0%
	SSF006	0.3%	0.6%	0.0%
Main Stem	SMS000	1.7%	1.9%	1.5%

**Table H.2 Sewer Sep. Scenario 2000 – 2004 Max Excursion Frequency (%)**

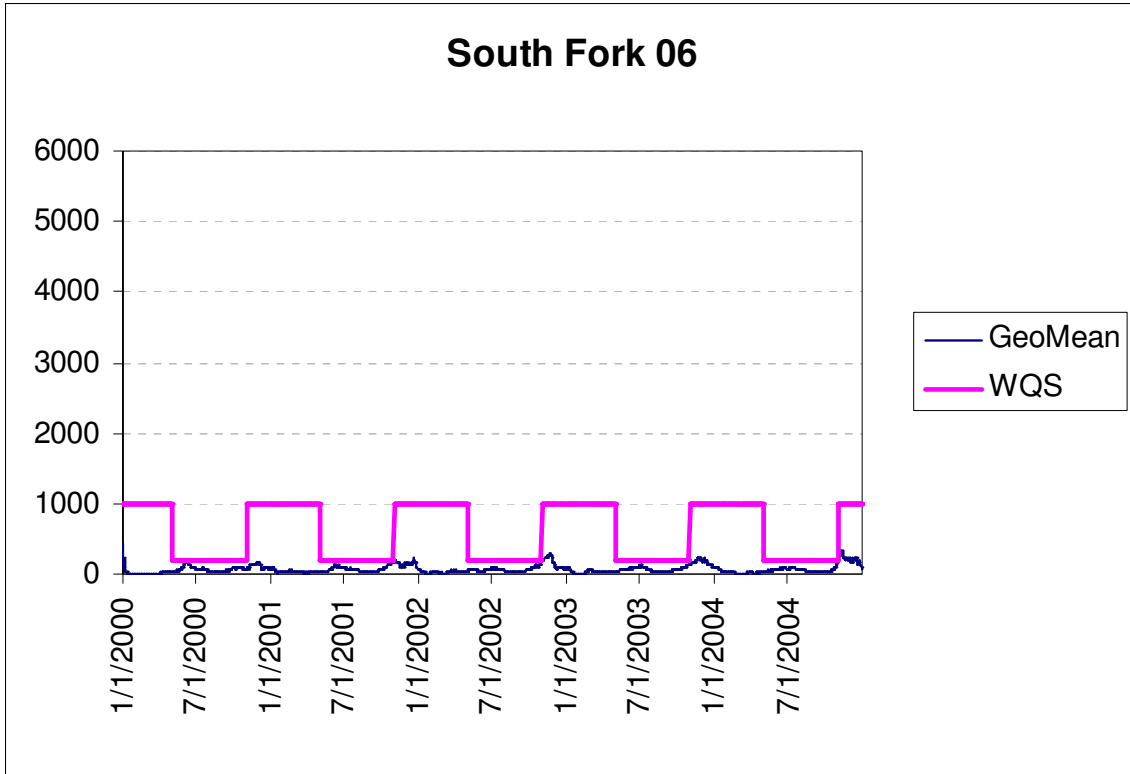
Sub-Watershed	Reporting Sub-basin	All	Season	
		Data	Winter	Recreation
Muddy Fork	SMU004	7.1	3.7	10.5
	SMU002	6.6	3.5	9.6
	SMU000	6.4	1.9	10.8
Middle Fork	SMI002	6.5	3.0	10.0
	SMI004	7.0	3.1	10.8
	SMI000	7.2	2.9	11.4
South Fork	SSF001	6.8	3.1	10.4
	SSF002	6.9	3.2	10.5
	SSF000	6.7	2.8	10.6
	SSF006	6.4	1.8	11.0
Main Stem	SMS000	5.6	1.2	10.0



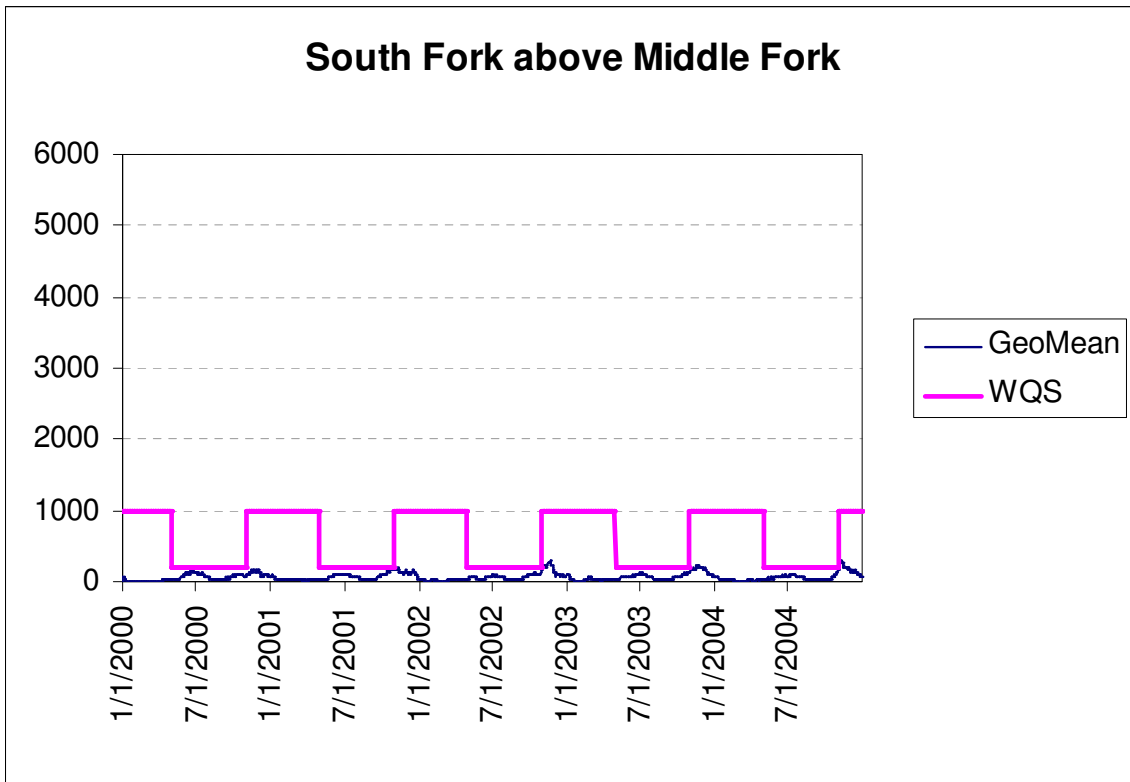
**Figure H.1 Geomean vs. Water Quality Standard Reporting Sub-basin SSF001**



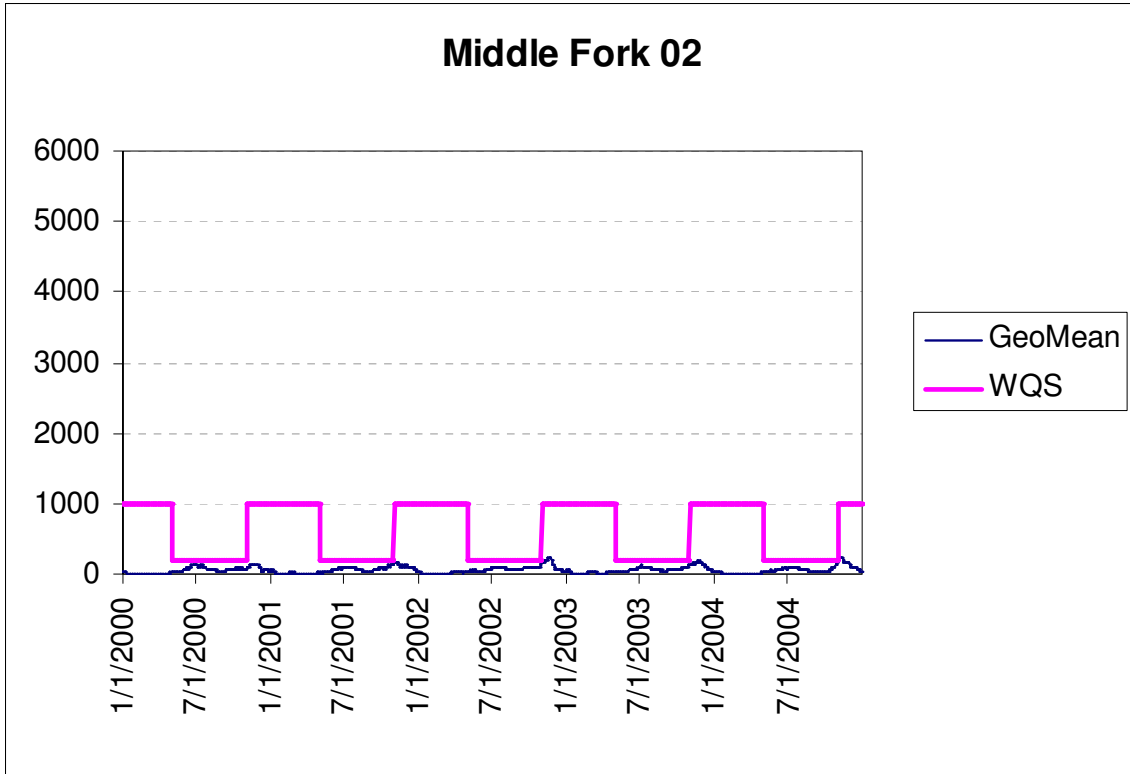
**Figure H.2 Geomean vs. Water Quality Standard Reporting Sub-basin SSF002**



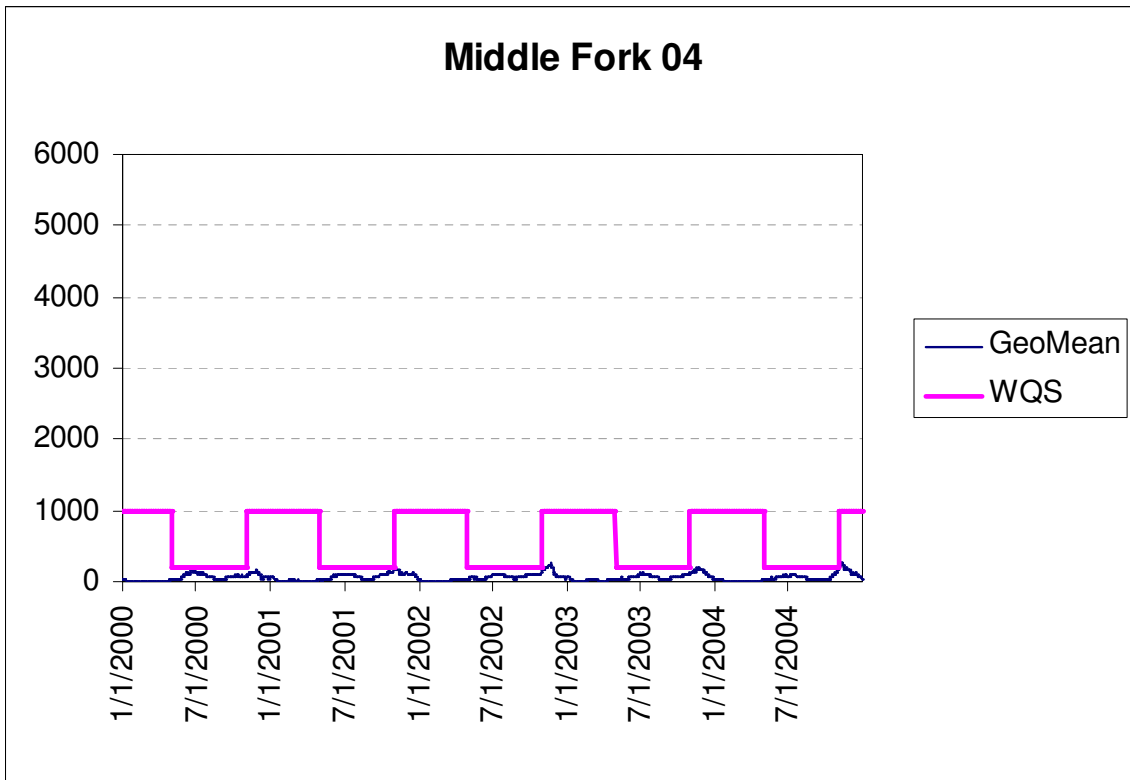
**Figure H.3 Geomean vs. Water Quality Standard Reporting Sub-basin SSF006**



**Figure H.4 Geomean vs. Water Quality Standard Reporting Sub-basin SSF000**



**Figure H.5 Geomean vs. Water Quality Standard Reporting Sub-basin SMI002**



**Figure H.6 Geomean vs. Water Quality Standard Reporting Sub-basin SMI004**

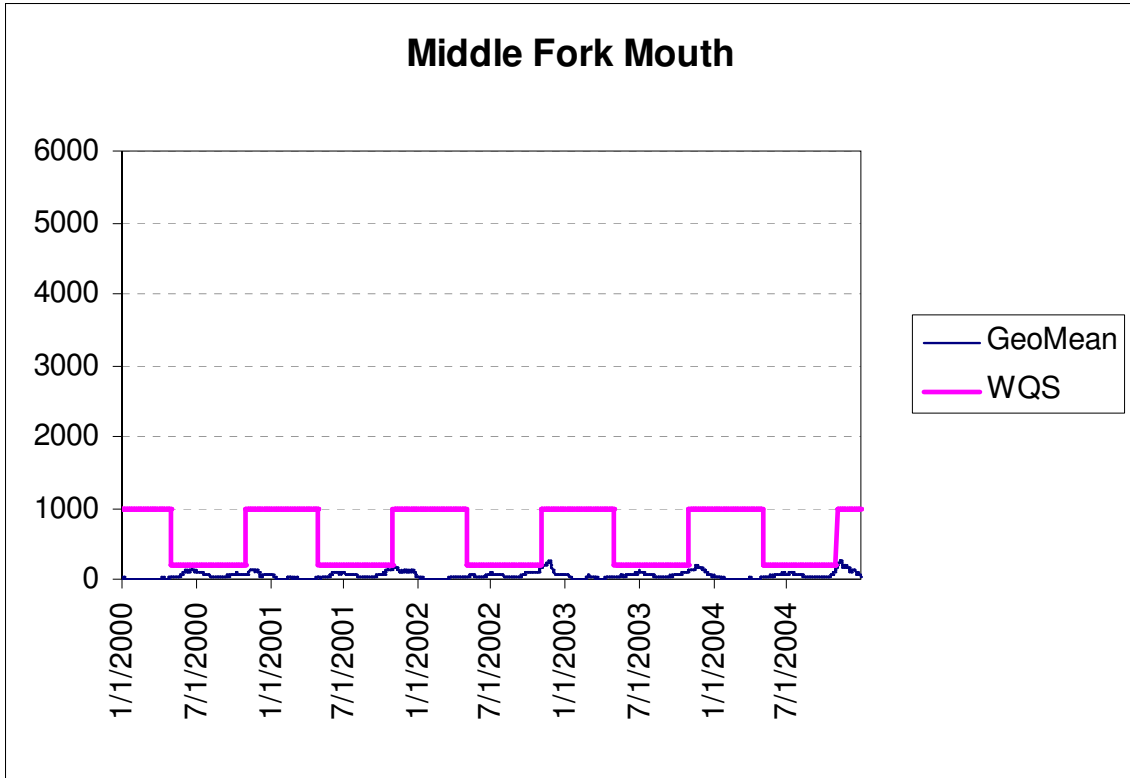


Figure H.7 Geomean vs. Water Quality Standard Reporting Sub-basin SMI000

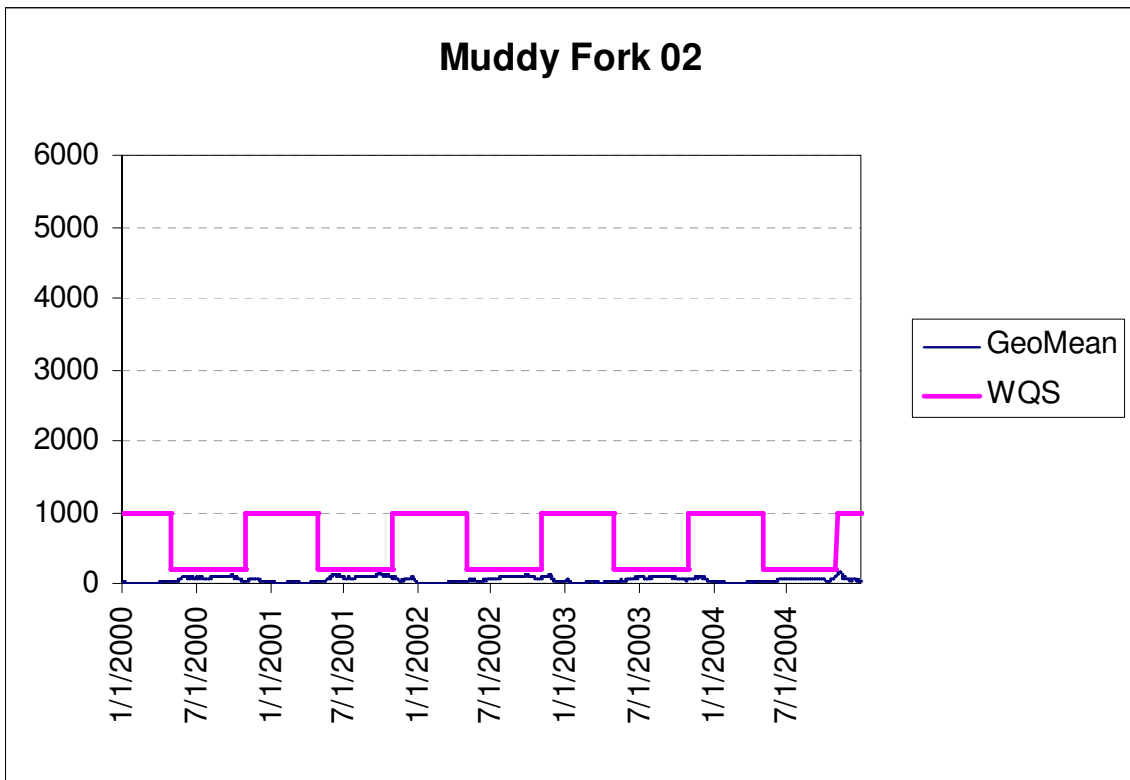


Figure H.8 Geomean vs. Water Quality Standard Reporting Sub-basin SMU002

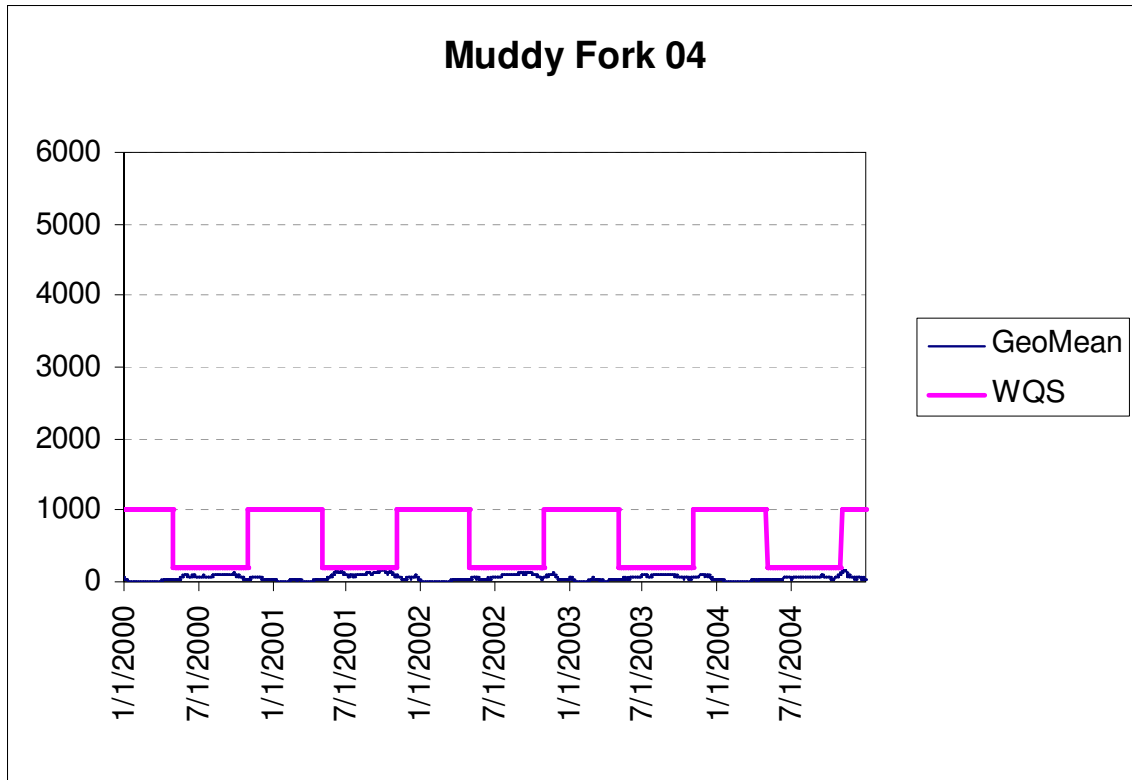


Figure H.9 Geomean vs. Water Quality Standard Reporting Sub-basin SMU004

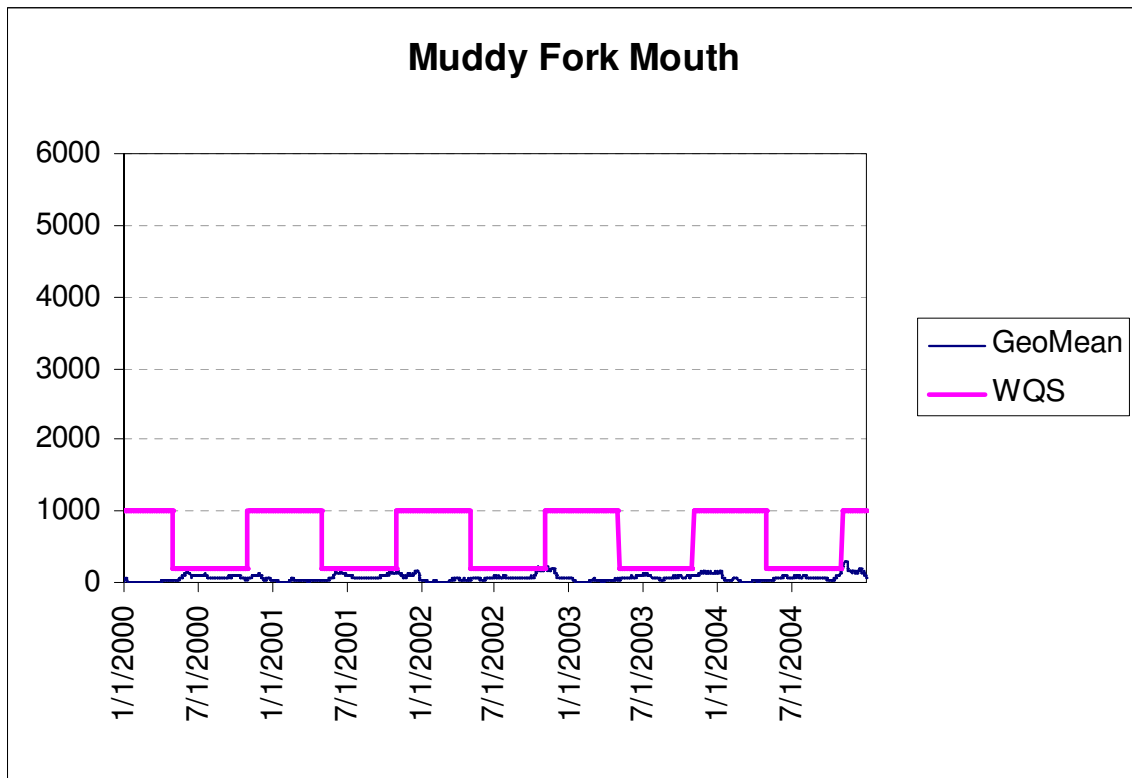


Figure H.10 Geomean vs. Water Quality Standard Reporting Sub-basin SMU000

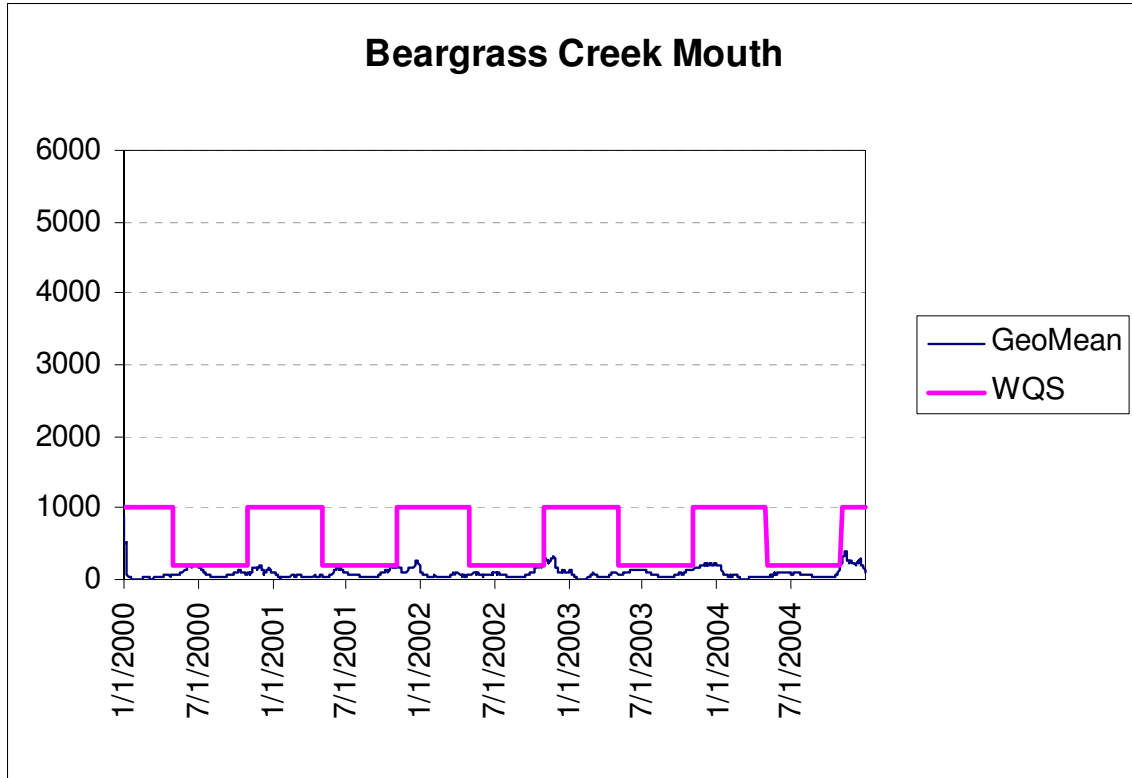


Figure H.11 Geomean vs. Water Quality Standard Reporting Sub-basin SMS000

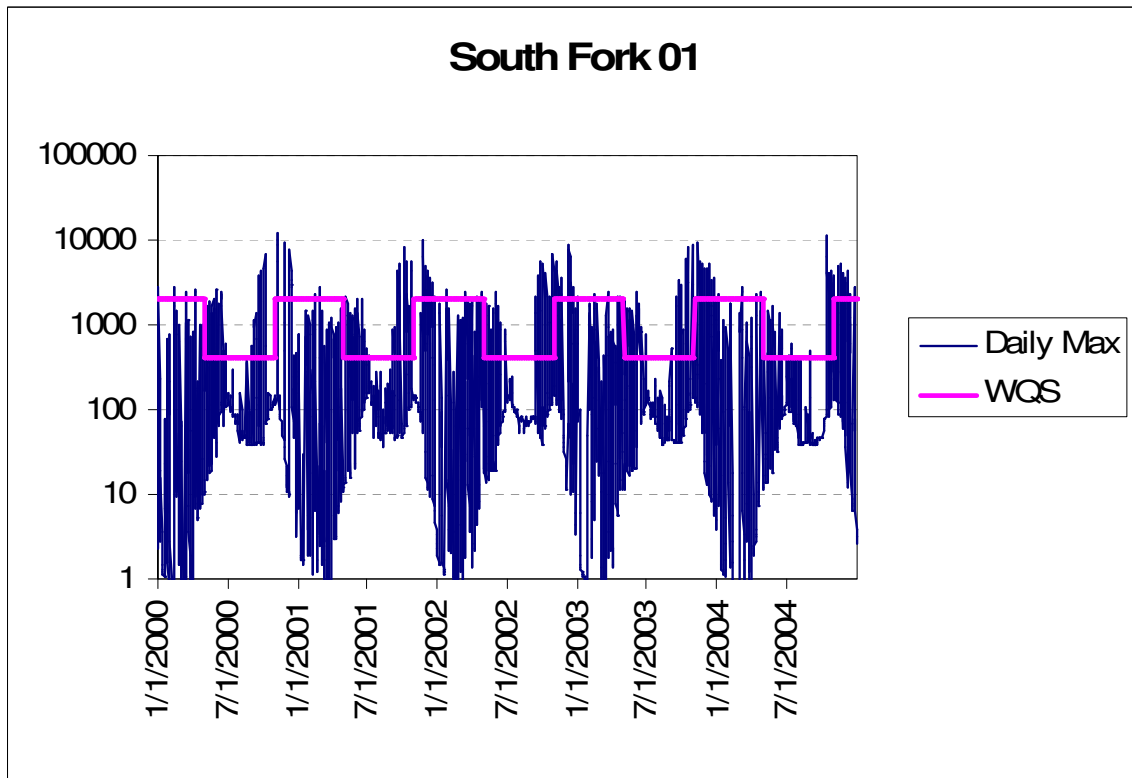


Figure H.12 Daily Max vs. Water Quality Standard Reporting Sub-basin SSF001

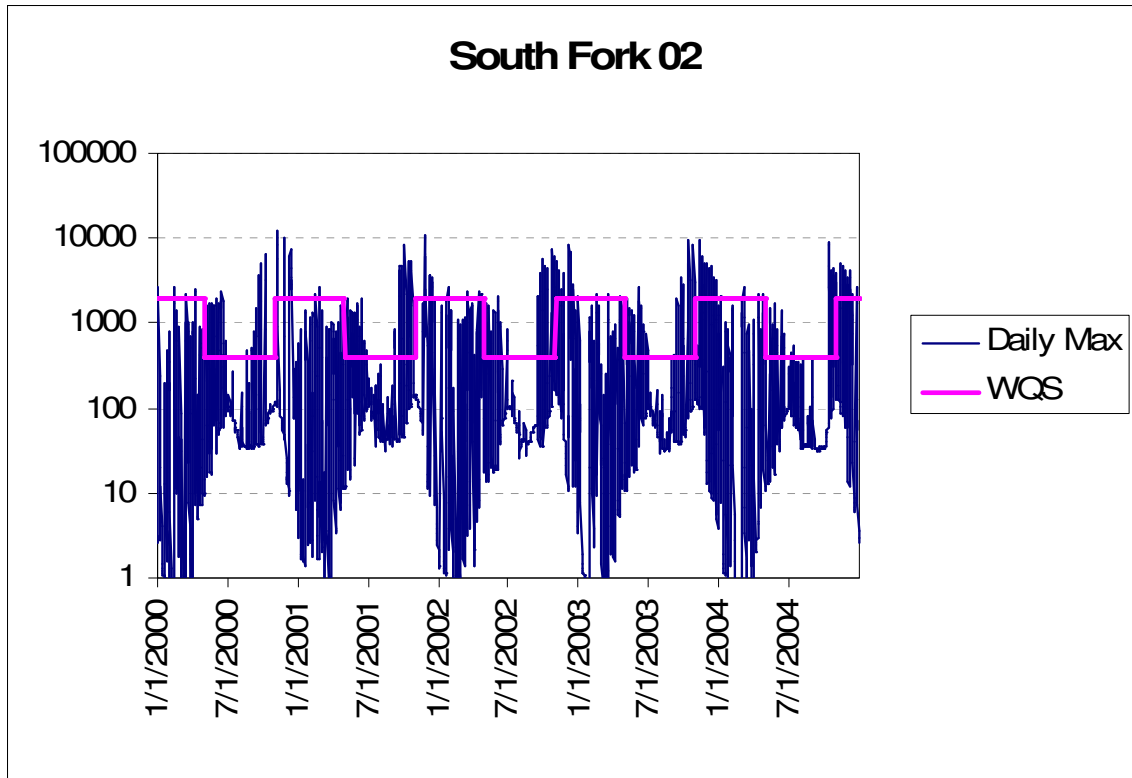


Figure H.13 Daily Max vs. Water Quality Standard Reporting Sub-basin SSF002

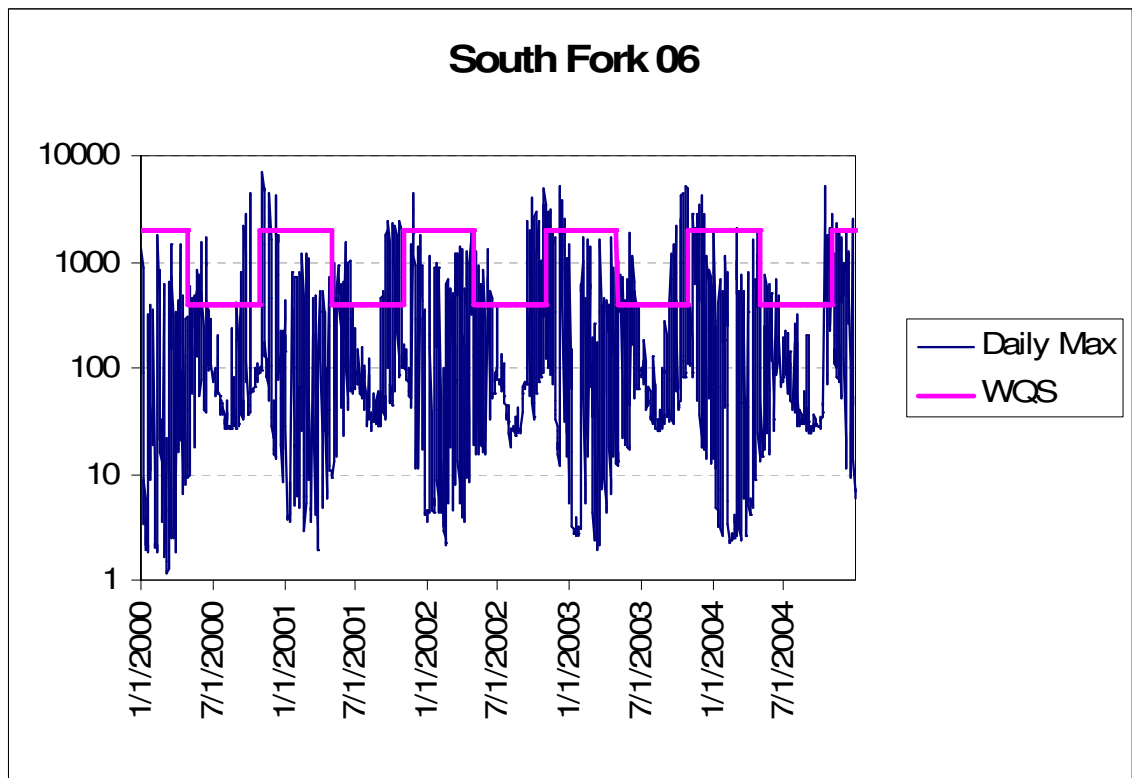


Figure H.14 Daily Max vs. Water Quality Standard Reporting Sub-basin SSF006



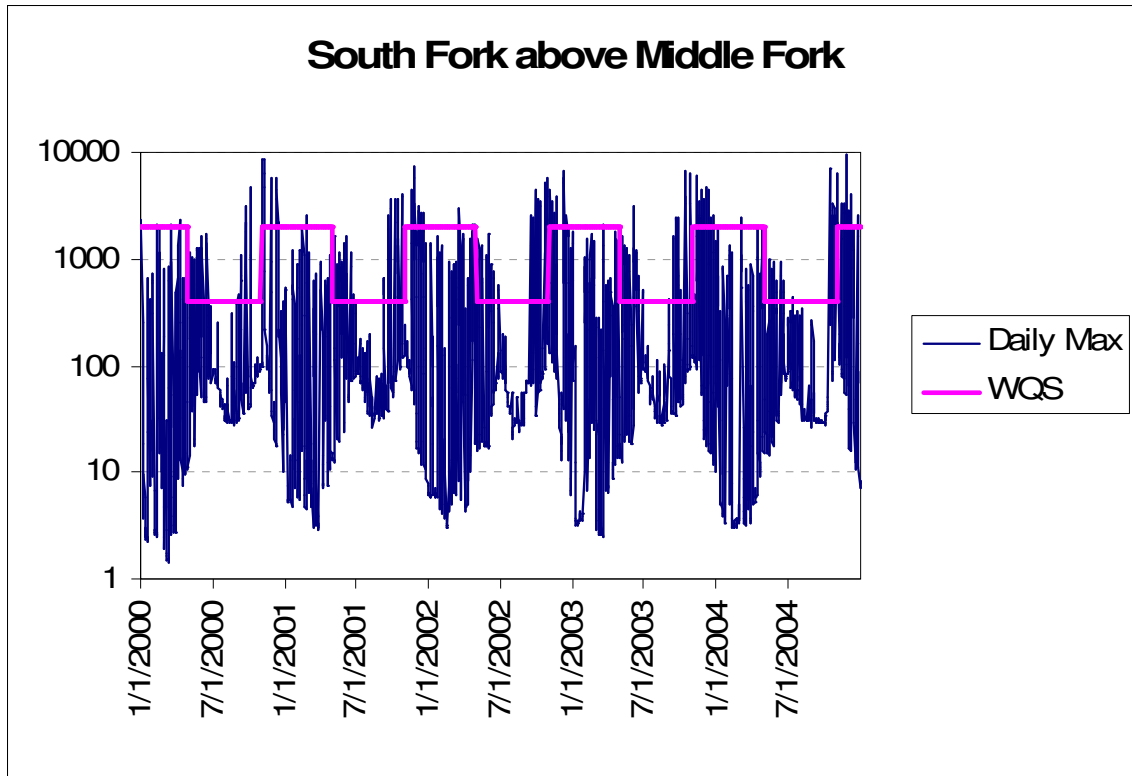


Figure H.15 Daily Max vs. Water Quality Standard Reporting Sub-basin SSF000

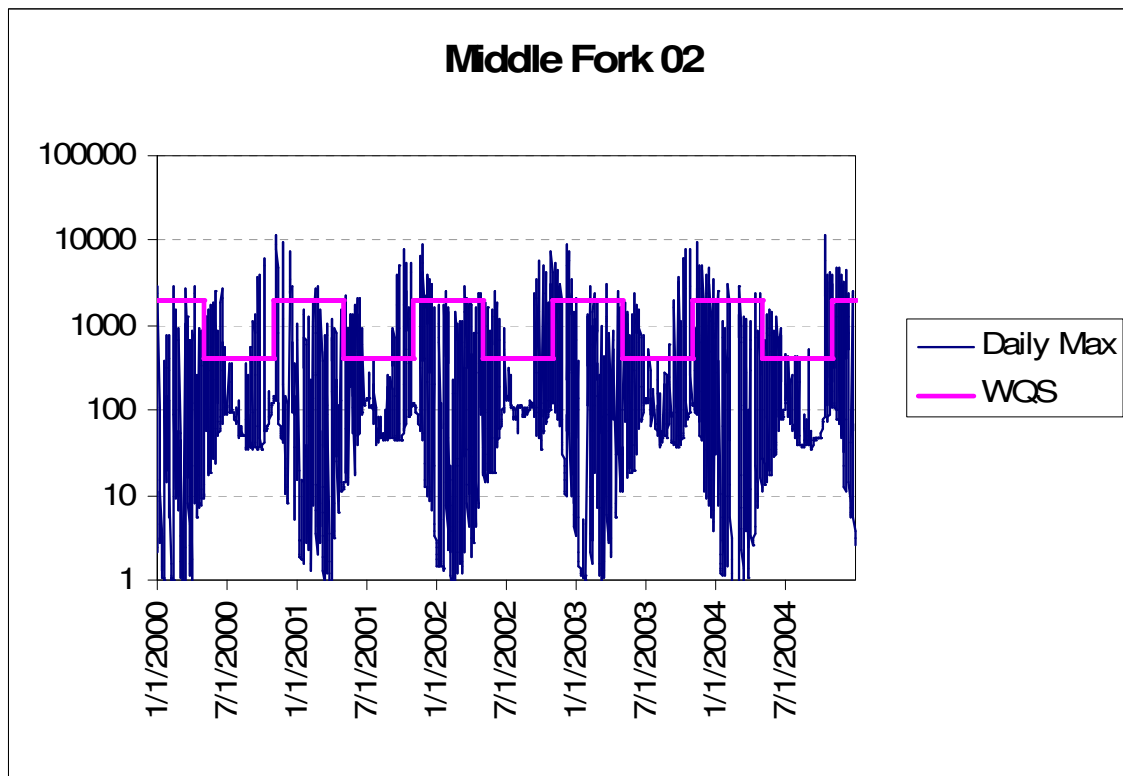


Figure H.16 Daily Max vs. Water Quality Standard Reporting Sub-basin SMI002

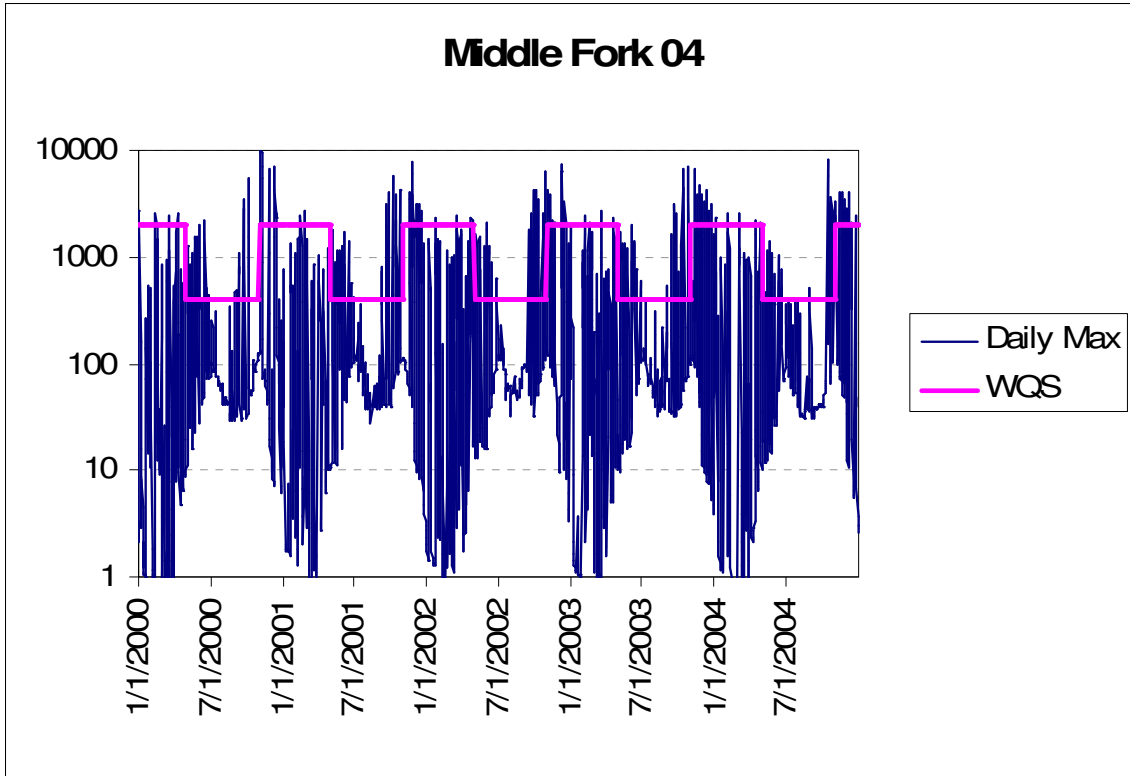


Figure H.17 Daily Max vs. Water Quality Standard Reporting Sub-basin SMI004

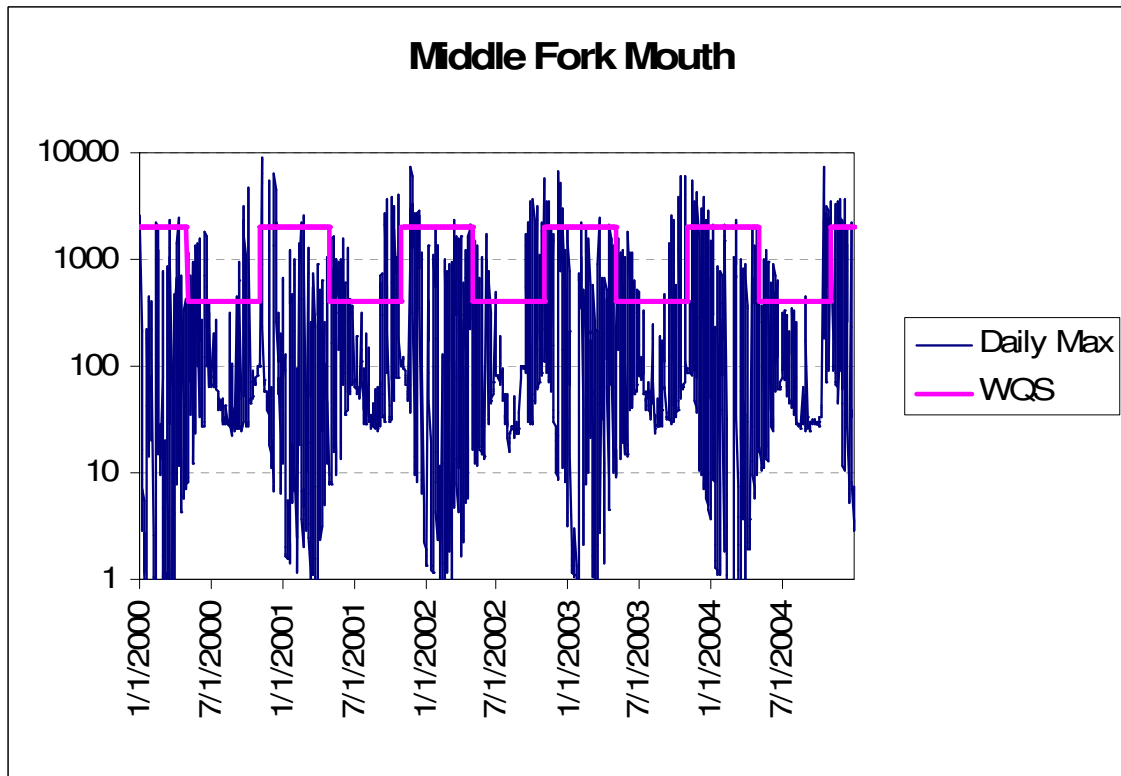


Figure H.18 Daily Max vs. Water Quality Standard Reporting Sub-basin SMI000

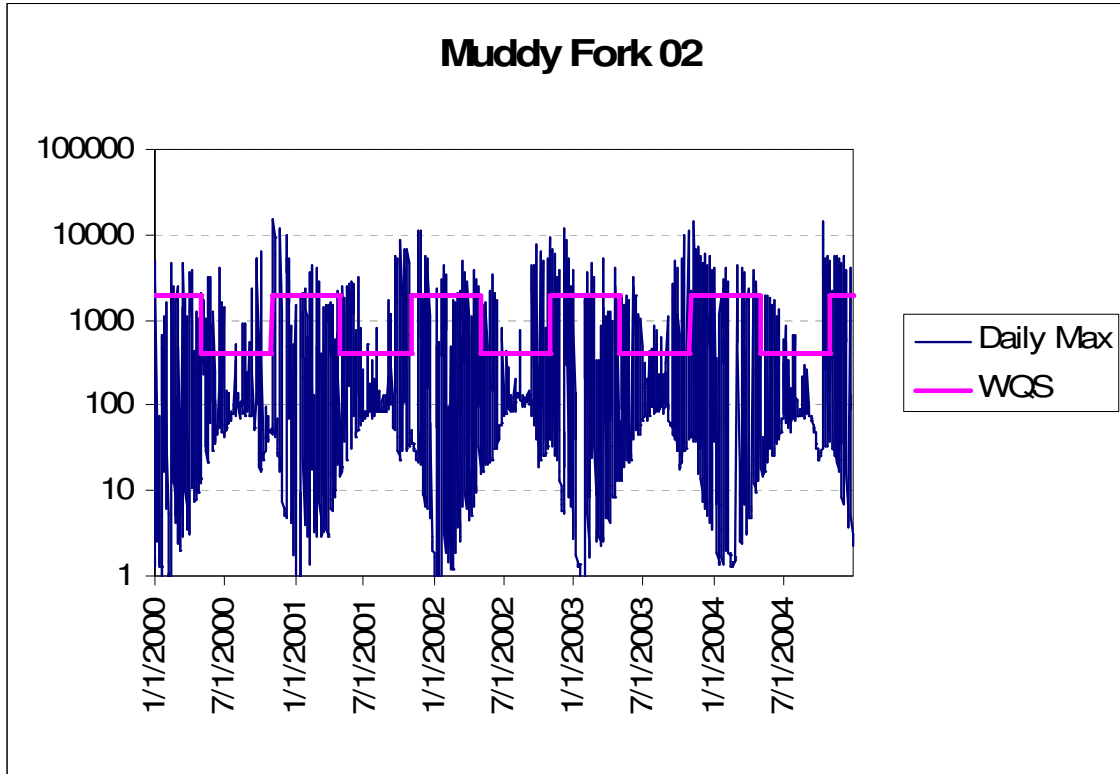


Figure H.19 Daily Max vs. Water Quality Standard Reporting Sub-basin SMU002

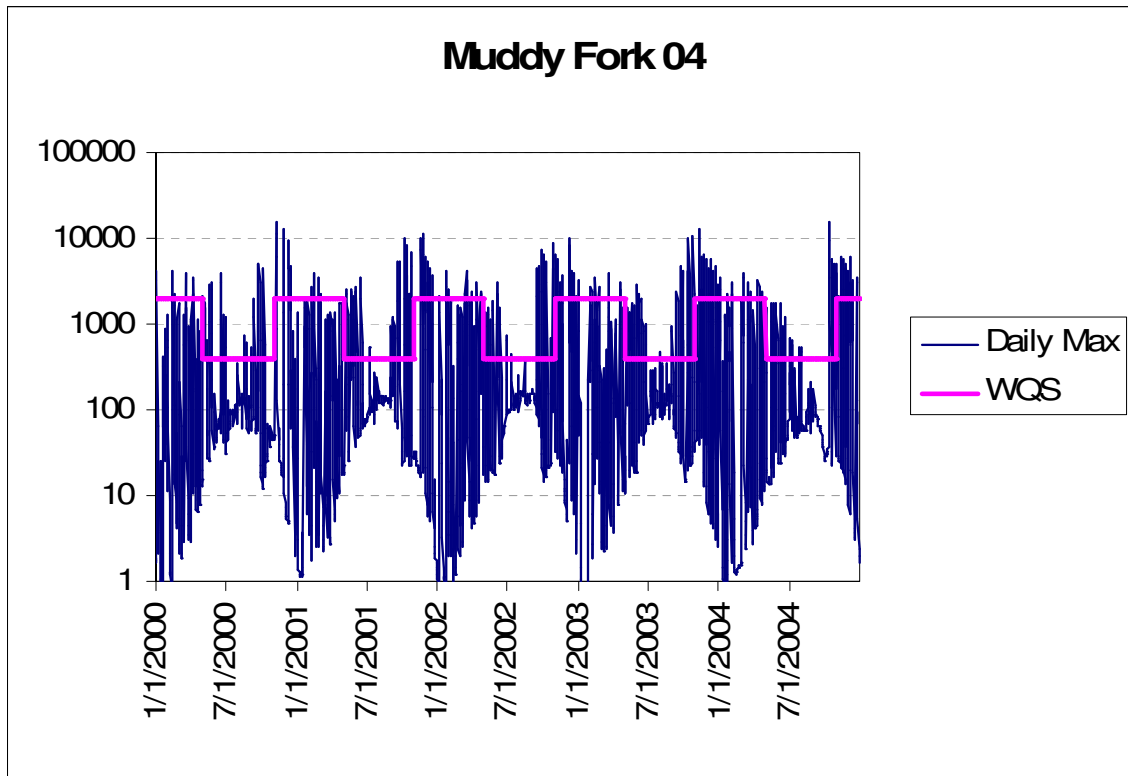


Figure H.20 Daily Max vs. Water Quality Standard Reporting Sub-basin SMU004

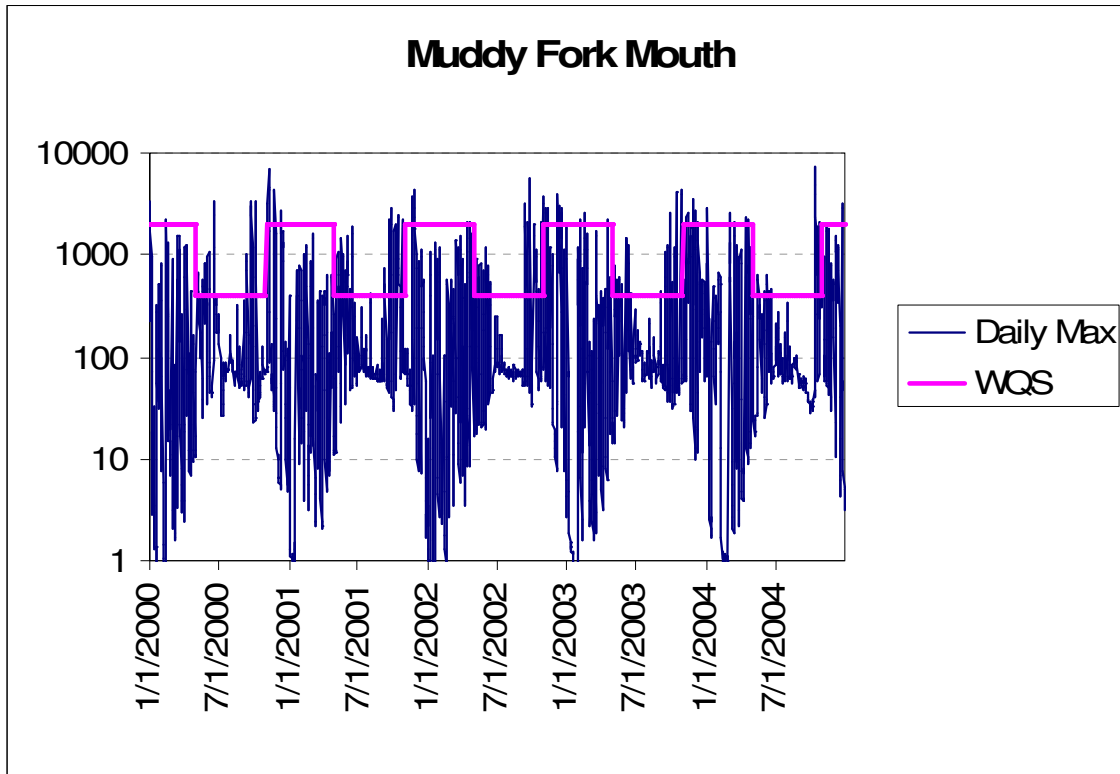


Figure H.21 Daily Max vs. Water Quality Standard Reporting Sub-basin SMU000

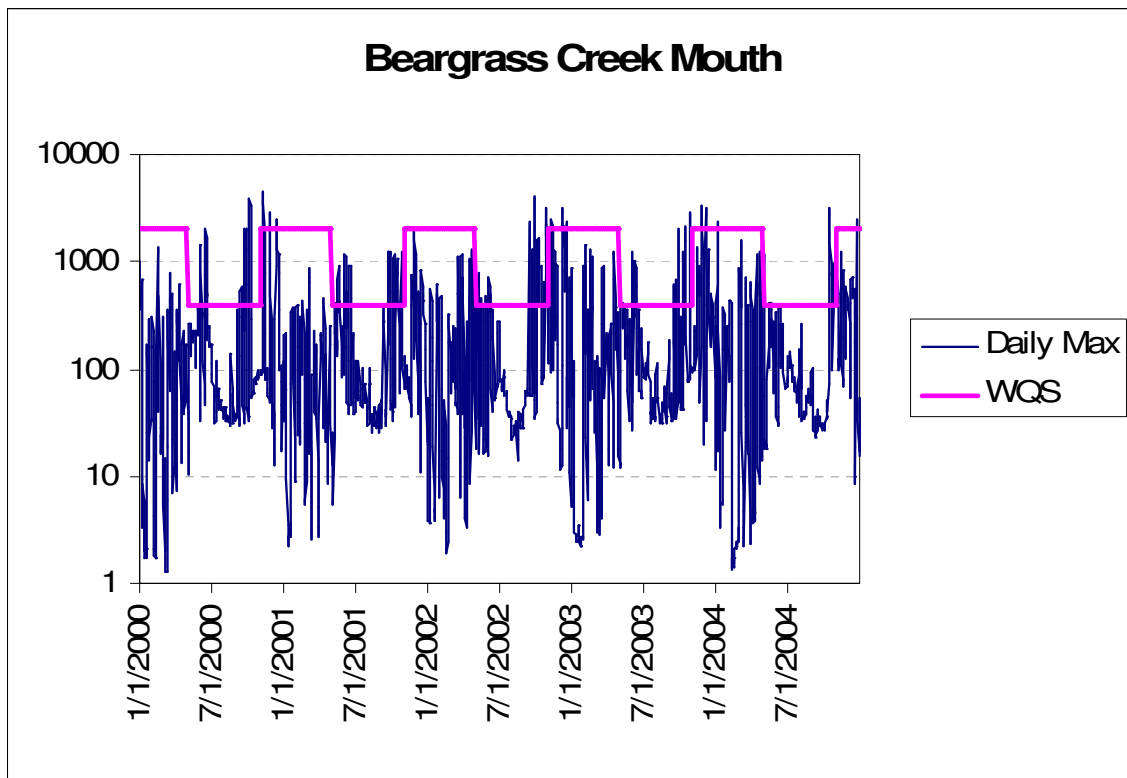


Figure H.22 Daily Max vs. Water Quality Standard Reporting Sub-basin SMS000